

和風の家  
山峯

*Mount  
Regalia*

Sales Brochure  
售樓說明書







# NOTES TO PURCHASERS OF FIRST-HAND RESIDENTIAL PROPERTIES

## 一手住宅物業買家須知

You are advised to take the following steps before purchasing first-hand residential properties.

### FOR ALL FIRST-HAND RESIDENTIAL PROPERTIES

#### 1. Important information

- Make reference to the materials available on the Sales of First-hand Residential Properties Electronic Platform (SRPE) ([www.srpe.gov.hk](http://www.srpe.gov.hk)) on the first-hand residential property market.
- Study the information on the website designated by the vendor for the development, including the sales brochure, price lists, documents containing the sales arrangements, and the register of transactions of a development.
- Sales brochure for a development will be made available to the general public at least 7 days immediately before a date of sale while price list and sales arrangements will be made available at least 3 days immediately before the date of sale.
- Information on transactions can be found on the register of transactions on the website designated by the vendor for the development and the SRPE.

#### 2. Fees, mortgage loan and property price

- Calculate the total expenses of the purchase, such as solicitors' fees, mortgage charges, insurance fees and stamp duties.
- Check with banks to find out if you will be able to obtain the needed mortgage loan, select the appropriate payment method and calculate the amount of the mortgage loan to ensure it is within your repayment ability.
- Check recent transaction prices of comparable properties for comparison.
- Check with the vendor or the estate agent the estimated management fee, the amount of management fee payable in advance (if any), special fund payable (if any), the amount of reimbursement of the deposits for water, electricity and gas (if any), and/or the amount of debris removal fee (if any) you have to pay to the vendor or the manager of the development.

#### 3. Price list, payment terms and other financial incentives

- Vendors may not offer to sell all the residential properties that are covered in a price list. To know which residential properties the vendors may offer to sell, pay attention to the sales arrangements which will be announced by the vendors at least 3 days before the relevant residential properties are offered to be sold.
- Pay attention to the terms of payment as set out in a price list. If there are discounts on the price, gift, or any financial advantage or benefit to be made available in connection with the purchase of the residential properties, such information will also be set out in the price list.
- If you intend to opt for any mortgage loan plans offered by financial institutions specified by the vendor, before entering into a preliminary agreement for sale and purchase (PASP), you must study the details of various mortgage loan plans<sup>1</sup> as set out in the price list concerned. If you have any questions about these mortgage loan plans, you should check with the financial institutions concerned direct before entering into a PASP.

#### 4. Property area and its surroundings

- Pay attention to the area information in the sales brochure and price list, and price per square foot/metre in the price list. According to the Residential Properties (First-hand Sales) Ordinance (Cap. 621) (the Ordinance), vendors can only present the area and price per square foot and per square metre of a residential property using saleable area. Saleable area, in relation to a residential property, means the floor area of the residential property, and includes the floor area of every one of the following to the extent that it forms part of the residential property - (i) a balcony; (ii) a utility platform; and (iii) a verandah. The saleable area excludes the area of the following which forms part of the residential property - air-conditioning plant room; bay window; cockloft; flat roof; garden; parking space; roof; stairhood; terrace and yard.
- Floor plans of all residential properties in the development have to be shown in the sales brochure. In a sales brochure, floor plans of residential properties in the development must state the external and internal dimensions of each residential property<sup>2</sup>. The external and internal dimensions of residential properties as provided in the sales brochure exclude plaster and finishes. You are advised to note this if you want to buy furniture before handing over of the residential property.
- Visit the development site and get to know the surroundings of the property (including transportation and community facilities). Check town planning proposals and decisions which may affect the property. Take a look at the location plan, aerial photograph, outline zoning plan and cross-section plan that are provided in the sales brochure.

#### 5. Sales brochure

- Ensure that the sales brochure obtained is the latest version. According to the Ordinance, the sales brochure made

available to the public should be printed or examined, or examined and revised within the previous 3 months.

- In respect of an uncompleted development, the vendor may alter the building plans (if any) whenever the vendor considers necessary. To know the latest information of an uncompleted development, keep paying attention to any revised sales brochures made available by the vendor.
- Read through the sales brochure and in particular, check the following information in the sales brochure -
  - whether there is a section on “relevant information” in the sales brochure, under which information on any matter that is known to the vendor but is not known to the general public, and is likely to materially affect the enjoyment of a residential property will be set out. Please note that information contained in a document that has been registered with the Land Registry will not be regarded as “relevant information”;
  - the cross-section plan showing a cross-section of the building in relation to every street adjacent to the building, and the level of every such street in relation to a known datum and to the level of the lowest residential floor of the building. This will help you visualize the difference in height between the lowest residential floor of a building and the street level, regardless of how that lowest residential floor is named;
  - interior and exterior fittings and finishes and appliances;
  - the basis on which management fees are shared;
  - whether individual owners have obligations or need to share the expenses for managing, operating and maintaining the public open space or public facilities inside or outside the development, and the location of the public open space or public facilities; and
  - whether individual owners have responsibility to maintain slopes.

#### 6. Government land grant and Deed of Mutual Covenant (DMC)

- Read the Government land grant and the DMC (or the draft DMC). Information such as ownership of the rooftop and external walls can be found in the DMC. The vendor will provide copies of the Government land grant and the DMC (or the draft DMC) at the place where the sale is to take place for free inspection by prospective purchasers.
- Check the Government land grant on whether individual owners are liable to pay Government rent.
- Check the DMC on whether animals can be kept in the residential property.

#### 7. Information on Availability of Residential Properties for Selection at Sales Office

- Check with the vendor which residential properties are available for selection. If a “consumption table” is displayed by the vendor at the sales office, you may check from the table information on the progress of sale on a date of sale, including which residential properties are offered for sale at the beginning of that date of sale and which of them have been selected and sold during that date of sale.
- Do not believe in rumours about the sales condition of the development and enter into a PASP rashly.

#### 8. Register of Transactions

- Pay attention to the register of transactions for a development. A vendor must, within 24 hours after entering into a PASP with a purchaser, enter transaction information of the PASP in the register of transactions. The vendor must, within 1 working day after entering into an agreement for sale and purchase (ASP), enter transaction information of the ASP in the register of transactions. Check the register of transactions for the concerned development to learn more about the sales condition of the development.
- Never take the number of registrations of intent or cashier orders a vendor has received for the purpose of registration as an indicator of the sales volume of a development. The register of transactions for a development is the most reliable source of information from which members of the public can grasp the daily sales condition of the development.

<sup>1</sup> The details of various mortgage loan plans include the requirements for mortgagors on minimum income level, the loan limit under the first mortgage and second mortgage, the maximum loan repayment period, the change of mortgage interest rate throughout the entire repayment period, and the payment of administrative fees.

<sup>2</sup> According to section 10(2)(d) in Part 1 of Schedule 1 to the Ordinance, each of the floor plans of the residential properties in the development in the sales brochure must state the following—

- (i) the external dimensions of each residential property;
- (ii) the internal dimensions of each residential property;
- (iii) the thickness of the internal partitions of each residential property;
- (iv) the external dimensions of individual compartments in each residential property.

According to section 10(3) in Part 1 of Schedule 1 to the Ordinance, if any information required by section 10(2)(d) in Part 1 of Schedule 1 to the Ordinance is provided in the approved building plans for the development, a floor plan must state the information as so provided.

## NOTES TO PURCHASERS OF FIRST-HAND RESIDENTIAL PROPERTIES

### 一手住宅物業買家須知

#### 9. Agreement for sale and purchase

- Ensure that the PASP and ASP include the mandatory provisions as required by the Ordinance.
- Pay attention that fittings, finishes and appliances to be included in the sale and purchase of the property are inserted in the PASP and ASP.
- Pay attention to the area plan annexed to the ASP which shows the total area which the vendor is selling to you. The total area which the vendor is selling to you is normally greater than the saleable area of the property.
- Pay attention to the vendor's right to alter the building plans (if any) for an uncompleted development. The mandatory provisions to be incorporated in an ASP for uncompleted development as required by the Ordinance include a provision requiring the vendor to notify the purchaser in writing of such alteration if the same affects in any way the property within 14 days after its having been approved by the Building Authority.
- A preliminary deposit of 5% of the purchase price is payable by you to the owner (i.e. the seller) on entering into a PASP.
- If you do not execute the ASP within 5 working days (working day means a day that is not a general holiday or a Saturday or a black rainstorm warning day or gale warning day) after entering into the PASP, the PASP is terminated, the preliminary deposit (i.e. 5% of the purchase price) is forfeited, and the owner (i.e. the seller) does not have any further claim against you for not executing the ASP.
- If you execute the ASP within 5 working days after the signing of the PASP, the owner (i.e. the seller) must execute the ASP within 8 working days after entering into the PASP.
- The deposit should be made payable to the solicitors' firm responsible for stakeholding purchasers' payments for the property.

#### 10. Expression of intent of purchasing a residential property

- Note that vendors (including their authorized representative(s)) should not seek or accept any specific or general expression of intent of purchasing any residential property before the relevant price lists for such properties are made available to the public. You therefore should not make such an offer to the vendors or their authorized representative(s).
- Note that vendors (including their authorized representative(s)) should not seek or accept any specific expression of intent of purchasing a particular residential property before the sale of the property has commenced. You therefore should not make such an offer to the vendors or their authorized representative(s).

#### 11. Appointment of estate agent

- Note that if the vendor has appointed one or more than one estate agents to act in the sale of any specified residential property in the development, the price list for the development must set out the name of all the estate agents so appointed as at the date of printing of the price list.
- You may appoint any estate agent (not necessarily from those estate agency companies appointed by the vendor) to act in the purchase of any specified residential property in the development, and may also not appoint any estate agent to act on your behalf.
- Before you appoint an estate agent to look for a property, you should -
  - find out whether the agent will act on your behalf only. If the agent also acts for the vendor, he/she may not be able to protect your best interests in the event of a conflict of interest;
  - find out whether any commission is payable by you to the estate agent and, if so, its amount and the time of payment; and
  - note that only licensed estate agents or salespersons may accept your appointment. If in doubt, you should request the estate agent or salesperson to produce his/her Estate Agent Card, or check the Licence List on the Estate Agents Authority website: [www.eaa.org.hk](http://www.eaa.org.hk).

#### 12. Appointment of solicitor

- Consider appointing your own solicitor to protect your interests. If the solicitor also acts for the vendor, he/she may not be able to protect your best interests in the event of a conflict of interest.
- Compare the charges of different solicitors.

### FOR FIRST-HAND UNCOMPLETED RESIDENTIAL PROPERTIES

#### 13. Pre-sale Consent

- For uncompleted residential property under the Lands Department Consent Scheme, seek confirmation from the vendor whether the "Pre-sale Consent" has been issued by the Lands Department for the development.

#### 14. Show flats

- While the vendor is not required to make any show flat available for viewing by prospective purchasers or the general public, if the vendor wishes to make available show flats of a specified residential property, the vendor must first of all

make available an unmodified show flat of that residential property and that, having made available such unmodified show flat, the vendor may then make available a modified show flat of that residential property. In this connection, the vendor is allowed to make available more than one modified show flat of that residential property.

- If you visit the show flats, you should always look at the unmodified show flats for comparison with the modified show flats. That said, the Ordinance does not restrict the discretion of the vendor in arranging the sequence of the viewing of unmodified and modified show flats.
- Sales brochure of the development should have been made available to the public when the show flat is made available for viewing. You are advised to get a copy of the sales brochure and make reference to it when viewing the show flats.
- You may take measurements in modified and unmodified show flats, and take photographs or make video recordings of unmodified show flats, subject to reasonable restriction(s) which may be set by the vendor for ensuring safety of the persons viewing the show flat.

### FOR FIRST-HAND UNCOMPLETED RESIDENTIAL PROPERTIES AND COMPLETED RESIDENTIAL PROPERTIES PENDING COMPLIANCE

#### 15. Estimated material date and handing over date

- Check the estimated material date<sup>3</sup> for the development in the sales brochure.
  - The estimated material date for a development in the sales brochure is not the same as the date on which a residential property is handed over to purchaser. The latter is normally later than the former. However, the handing over date may be earlier than the estimated material date set out in the sales brochure in case of earlier completion of the development.
- Handing over date
  - The mandatory provisions to be incorporated in an ASP as required by the Ordinance include a provision requiring the vendor to apply in writing for an Occupation Document/a Certificate of Compliance or the Director of Lands' Consent to Assign (as the case may be) in respect of the development within 14 days after the estimated material date as stipulated in the ASP.
    - For development subject to the Lands Department Consent Scheme, the vendor is required to notify the purchaser in writing that the vendor is in a position validly to assign the property within one month after the issue of the Certificate of Compliance or the Consent to Assign, whichever first happens; or
    - For development not subject to the Lands Department Consent Scheme, the vendor is required to notify the purchaser in writing that the vendor is in a position validly to assign the property within 6 months after the issue of the Occupation Document including Occupation Permit.
  - The mandatory provisions to be incorporated in an ASP as required by the Ordinance include a provision requiring completion of the sale and purchase within 14 days after the date of the notification aforesaid. Upon completion, the vendor shall arrange handover of the property to the purchaser.
- Authorized Person (AP) may grant extension(s) of time for completion of the development beyond the estimated material date.
  - The mandatory provisions to be incorporated in an ASP as required by the Ordinance include a provision that the AP of a development may grant an extension of time for completion of the development beyond the estimated material date having regard to delays caused exclusively by any one or more of the following reasons:
    - strike or lock-out of workmen;
    - riots or civil commotion;
    - force majeure or Act of God;
    - fire or other accident beyond the vendor's control;
    - war; or
    - inclement weather.
  - The AP may grant more than once such an extension of time depending on the circumstances. That means handover of the property may be delayed.
  - The mandatory provisions to be incorporated in an ASP as required by the Ordinance also include a provision requiring the vendor to, within 14 days after the issue of an extension of time granted by the AP, furnish the purchaser with a copy of the relevant certificate of extension.
- Ask the vendor if there are any questions on handing over date.

<sup>3</sup> Generally speaking, "material date" means the date on which the conditions of the land grant are complied with in respect of the development, or the date on which the development is completed in all respects in compliance with the approved building plans or the conditions subject to which the certificate of exemption is issued. For details, please refer to section 2 of the Ordinance.

## NOTES TO PURCHASERS OF FIRST-HAND RESIDENTIAL PROPERTIES

### 一手住宅物業買家須知

#### FOR FIRST-HAND COMPLETED RESIDENTIAL PROPERTIES

##### 16. Vendor's information form

- Ensure that you obtain the “vendor's information form(s)” printed within the previous 3 months in relation to the residential property/properties you intend to purchase.

##### 17. Viewing of property

- Ensure that, before you purchase a residential property, you are arranged to view the residential property that you would like to purchase or, if it is not reasonably practicable to view the property in question, a comparable property in the development, unless you agree in writing that the vendor is not required to arrange such a comparable property for viewing for you. You are advised to think carefully before signing any waiver.
- You may take measurements, take photographs or make video recordings of the property, unless the property is held under a tenancy or reasonable restriction(s) is/are needed to ensure safety of the persons viewing the property.

For complaints and enquiries relating to the sales of first -hand residential properties by the vendors which the Ordinance applies, please contact the Sales of First-hand Residential Properties Authority -

Website	: www.srpa.gov.hk
Telephone	: 2817 3313
Email	: enquiry_srpa@hd.gov.hk
Fax	: 2219 2220

Other useful contacts -

<b>Consumer Council</b>	
Website	: www.consumer.org.hk
Telephone	: 2929 2222
Email	: cc@consumer.org.hk
Fax	: 2856 3611

<b>Estate Agents Authority</b>	
Website	: www.eaa.org.hk
Telephone	: 2111 2777
Email	: enquiry@eaa.org.hk
Fax	: 2598 9596

<b>Real Estate Developers Association of Hong Kong</b>	
Telephone	: 2826 0111
Fax	: 2845 2521

Sales of First-hand Residential Properties Authority  
March 2023



# NOTES TO PURCHASERS OF FIRST-HAND RESIDENTIAL PROPERTIES

## 一手住宅物業買家須知

您在購置一手住宅物業之前，應留意下列事項：

### 適用於所有一手住宅物業

#### 1. 重要資訊

- 瀏覽一手住宅物業銷售資訊網（下稱「銷售資訊網」）（網址：[www.srpe.gov.hk](http://www.srpe.gov.hk)），參考「銷售資訊網」內有關一手住宅物業的市場資料。
- 閱覽賣方就該發展項目所指定的互聯網網站內的有關資訊，包括售樓說明書、價單、載有銷售安排的文件，及成交紀錄冊。
- 發展項目的售樓說明書，會在該項目的出售日期前最少七日向公眾發布，而有關價單和銷售安排，亦會在該項目的出售日期前最少三日公布。
- 在賣方就有關發展項目所指定的互聯網網站，以及「銷售資訊網」內，均載有有關物業成交資料的成交紀錄冊，以供查閱。

#### 2. 費用、按揭貸款和樓價

- 計算置業總開支，包括律師費、按揭費用、保險費，以及印花稅。向銀行查詢可否取得所需的按揭貸款，然後選擇合適的還款方式，並小心計算按揭貸款金額，以確保貸款額沒有超出本身的負擔能力。
- 查閱同類物業最近的成交價格，以作比較。
- 向賣方或地產代理瞭解，您須付予賣方或該發展項目的管理人的預計的管理費、管理費上期金額（如有）、特別基金金額（如有）、補還的水、電力及氣體按金（如有），以及／或清理廢料的費用（如有）。

#### 3. 價單、支付條款，以及其他財務優惠

- 賣方未必會把價單所涵蓋的住宅物業悉數推售，因此應留意有關的銷售安排，以了解賣方會推售的住宅物業為何。賣方會在有關住宅物業推售日期前最少三日公布銷售安排。
- 留意價單所載列的支付條款。倘買家可就購置有關住宅物業而連帶獲得價格折扣、贈品，或任何財務優惠或利益，上述資訊亦會在價單內列明。
- 如您擬選用由賣方指定的財務機構提供的各類按揭貸款計劃，在簽訂臨時買賣合約前，應先細閱有關價單內列出的按揭貸款計劃資料<sup>1</sup>。如就該些按揭貸款計劃的詳情有任何疑問，應在簽訂臨時買賣合約前，直接向有關財務機構查詢。

#### 4. 物業的面積及四周環境

- 留意載於售樓說明書和價單內的物業面積資料，以及載於價單內的每平方呎／每平方米售價。根據《一手住宅物業銷售條例》（第 621 章）（下稱「條例」），賣方只可以實用面積表達住宅物業的面積和每平方呎及平方米的售價。就住宅物業而言，實用面積指該住宅物業的樓面面積，包括在構成該物業的一部分的範圍內的以下每一項目的樓面面積：(i) 露台；(ii) 工作平台；以及 (iii) 陽台。實用面積並不包括空調機房、窗台、閣樓平台、花園、停車位、天台、梯屋、前庭及庭院的每一項目的面積，即使該些項目構成該物業的一部分的範圍。
- 售樓說明書必須顯示發展項目中所有住宅物業的樓面平面圖。在售樓說明書所載有關發展項目中住宅物業的每一份樓面平面圖，均須述明每個住宅物業的外部及內部尺寸<sup>2</sup>。售樓說明書所提供有關住宅物業外部和內部的尺寸，不會把批盪和裝飾物料包括在內。買家收樓前如欲購置家具，應留意這點。
- 親臨發展項目的所在地實地視察，以了解有關物業的四周環境（包括交通和社區設施）；亦應查詢有否任何城市規劃方案和議決，會對有關的物業造成影響；參閱載於售樓說明書內的位置圖、鳥瞰照片、分區計劃大綱圖，以及橫截面圖。

#### 5. 售樓說明書

- 確保所取得的售樓說明書屬最新版本。根據條例，提供予公眾的售樓說明書必須是在之前的三個月之內印製或檢視、或檢視及修改。
- 如屬未落成發展項目，賣方在認為有需要時可改動建築圖則（如有的話），因此應留意由賣方提供的任何經修改的售樓說明書，以了解有關未落成發展項目的最新資料。
- 閱覽售樓說明書，並須特別留意以下資訊
  - 售樓說明書內有否關於「有關資料」的部分，列出賣方知悉但並非為一般公眾人士所知悉，關於相當可能對享用有關住宅物業造成重大影響的事宜的資料。請注意，已在土地註冊處註冊的文件，其內容不會被視為「有關資料」；
  - 橫截面圖會顯示有關建築物相對毗連該建築物的每條街道的橫截面，以及每條上述街道與已知基準面和該

建築物最低的一層住宅樓層的水平相對的水平。橫截面圖能以圖解形式，顯示出建築物最低一層住宅樓層和街道水平的高低差距，不論該最低住宅樓層以何種方式命名；

- 室內和外部的裝置、裝修物料和設備；
- 管理費按甚麼基準分擔；
- 小業主有否責任或需要分擔管理、營運或維持有關發展項目以內或以外的公眾休憩用地或公共設施的開支，以及有關公眾休憩用地或公共設施的位置；以及
- 小業主是否須要負責維修斜坡。

#### 6. 政府批地文件和公契

- 閱覽政府批地文件和公契（或公契擬稿）。公契內載有天台和外牆業權等相關資料。賣方會在售樓處提供政府批地文件和公契（或公契擬稿）的複本，供準買家免費閱覽。
- 留意政府批地文件內所訂明小業主是否須要負責支付地稅。
- 留意公契內訂明有關物業內可否飼養動物。

#### 7. 售樓處內有關可供揀選住宅物業的資料

- 向賣方查詢清楚有哪些一手住宅物業可供揀選。若賣方在售樓處內展示「消耗表」，您可從該「消耗表」得悉在每個銷售日的銷售進度資料，包括在該個銷售日開始時有哪些住宅物業可供出售，以及在該個銷售日內有哪些住宅物業已獲揀選及售出。切勿隨便相信有關發展項目銷情的傳言，倉卒簽立臨時買賣合約。

#### 8. 成交紀錄冊

- 留意發展項目的成交紀錄冊。賣方須於臨時買賣合約訂立後的 24 小時內，於紀錄冊披露該臨時買賣合約的資料，以及於買賣合約訂立後一個工作天內，披露該買賣合約的資料。您可透過成交紀錄冊得悉發展項目的銷售情況。
- 切勿將賣方接獲用作登記的購樓意向書或本票的數目視為銷情指標。發展項目的成交紀錄冊才是讓公眾掌握發展項目每日銷售情況的最可靠資料來源。

#### 9. 買賣合約

- 確保臨時買賣合約和買賣合約包含條例所規定的強制性條文。
- 留意有關物業買賣交易所包括的裝置、裝修物料和設備，須在臨時買賣合約和買賣合約上列明。
- 留意夾附於買賣合約的圖則。該圖則會顯示所有賣方售予您的物業面積，而該面積通常較該物業的實用面積為大。
- 留意賣方有權改動未落成發展項目的建築圖則（如有的話）。如屬未落成發展項目，條例規定物業的買賣合約須載有強制性條文，列明如有關改動在任何方面對該物業造成影響，賣方須在改動獲建築事務監督批准後的14日內，將該項改動以書面通知買家。
- 訂立臨時買賣合約時，您須向擁有人（即賣方）支付樓價5%的臨時訂金。如您在訂立臨時買賣合約後五個工作日（工作日指並非公眾假日、星期六、黑色暴雨警告日或烈風警告日的日子）之內，沒有簽立買賣合約，該臨時買賣合約即告終止，有關臨時訂金（即樓價的5%）會被沒收，而擁有人（即賣方）不得因您沒有簽立買賣合約而對您提出進一步申索。
- 在訂立臨時買賣合約後的五個工作日之內，倘您簽立買賣合約，則擁有人（即賣方）必須在訂立該臨時買賣合約後的八個工作日之內簽立買賣合約。
- 有關的訂金，應付予負責為所涉物業擔任保證金保存人的律師事務所。

<sup>1</sup> 按揭貸款計劃的資料包括有關按揭貸款計劃對借款人的最低收入的要求、就第一按揭連同第二按揭可獲得的按揭貸款金額上限、最長還款年期、整個還款期內的按揭利率變化，以及申請人須繳付的手續費。

<sup>2</sup> 根據條例附表1第1部第10(2)(d)條述明，售樓說明書內顯示的發展項目中的住宅物業的每一份樓面平面圖須述明以下各項—

- (i) 每個住宅物業的外部尺寸；
- (ii) 每個住宅物業的內部尺寸；
- (iii) 每個住宅物業的內部間隔的厚度；
- (iv) 每個住宅物業內個別分隔室的外部尺寸。

根據條例附表1第1部第10(3)條，如有關發展項目的經批准的建築圖則，提供條例附表1第1部第10(2)(d)條所規定的資料，樓面平面圖須述明如此規定的該資料。

### 10. 表達購樓意向

- 留意在賣方（包括其獲授權代表）就有關住宅物業向公眾提供價單前，賣方不得尋求或接納任何對有關住宅物業的購樓意向（不論是否屬明確選擇購樓意向）。因此您不應向賣方或其授權代表提出有關意向。
- 留意在有關住宅物業的銷售開始前，賣方（包括其獲授權代表）不得尋求或接納任何對該物業的有明確選擇購樓意向。因此您不應向賣方或其授權代表提出有關意向。

### 11. 委託地產代理

- 留意倘賣方委任一個或多於一個地產代理，以協助銷售其發展項目內任何指明住宅物業，該發展項目的價單必須列明在價單印刷日期當日所有獲委任為地產代理的姓名／名稱。
- 您可委託任何地產代理（不一定是賣方所指定的地產代理），以協助您購置發展項目內任何指明住宅物業；您亦可不委託任何地產代理。
- 委託地產代理以物色物業前，您應該—
  - 了解該地產代理是否只代表您行事。該地產代理若同時代表賣方行事，倘發生利益衝突，未必能夠保障您的最大利益；
  - 了解您須否支付佣金予該地產代理。若須支付，有關的佣金金額和支付日期為何；以及
  - 留意只有持牌地產代理或營業員才可以接受您的委託。如有疑問，應要求該地產代理或營業員出示其「地產代理證」，或瀏覽地產代理監管局的網頁（網址：[www.eaa.org.hk](http://www.eaa.org.hk)），查閱牌照目錄。

### 12. 委聘律師

- 考慮自行委聘律師，以保障您的利益。該律師若同時代表賣方行事，倘發生利益衝突，未必能夠保障您的最大利益。
- 比較不同律師的收費。

### 適用於一手未落成住宅物業

#### 13. 預售樓花同意書

- 洽購地政總署「預售樓花同意方案」下的未落成住宅物業時，應向賣方確認地政總署是否已就該發展項目批出「預售樓花同意書」。

#### 14. 示範單位

- 賣方不一定須設置示範單位供準買家或公眾參觀，但賣方如為某指明住宅物業設置示範單位，必須首先設置該住宅物業的無改動示範單位，才可設置該住宅物業的經改動示範單位，並可以就該住宅物業設置多於一個經改動示範單位。
- 參觀示範單位時，務必視察無改動示範單位，以便與經改動示範單位作出比較。然而，條例並沒有限制賣方安排參觀無改動示範單位及經改動示範單位的先後次序。
- 賣方設置示範單位供公眾參觀時，應已提供有關發展項目的售樓說明書。因此，緊記先行索取售樓說明書，以便在參觀示範單位時參閱相關資料。
- 您可以在無改動示範單位及經改動示範單位中進行量度，並在無改動示範單位內拍照或拍攝影片，惟在確保示範單位參觀者人身安全的前提下，賣方可能會設定合理的限制。

### 適用於一手未落成住宅物業及尚待符合條件的已落成住宅物業

#### 15. 預計關鍵日期及收樓日期

- 查閱售樓說明書中有關發展項目的預計關鍵日期<sup>3</sup>。
- 售樓說明書中有關發展項目的預計關鍵日期並不同買家的「收樓日期」。買家的「收樓日期」一般會較發展項目的預計關鍵日期遲。然而，假若發展項目比預期早落成，「收樓日期」可能會較售樓說明書列出的預計關鍵日期為早。

#### 收樓日期

- 條例規定買賣合約須載有強制性條文，列明賣方須於買賣合約內列出的預計關鍵日期後的14日內，以書面為發展項目申請佔用文件、合格證明書，或地政總署署長的轉讓同意（視屬何種情況而定）。
  - 如發展項目屬地政總署預售樓花同意方案所規管，賣方須在合格證明書或地政總署署長的轉讓同意發出後的一個月內（以較早者為準），就賣方有能力有效地轉讓有關物業一事，以書面通知買家；或
  - 如發展項目並非屬地政總署預售樓花同意方案所規管，賣方須在佔用文件（包括佔用許可證）發出後的六個月內，就賣方有能力有效地轉讓有關物業一事，以書面通知買家。
- 條例規定買賣合約須載有強制性條文，列明有關物業的買賣須於賣方發出上述通知的日期的14日內完成。有關物業的買賣完成後，賣方將安排買家收樓事宜。
- 認可人士可批予在預計關鍵日期之後完成發展項目
  - 條例規定買賣合約須載有強制性條文，列明發展項目的認可人士可以在顧及純粹由以下一個或多於一個原因所導致的延遲後，批予在預計關鍵日期之後，完成發展項目：
    - 工人罷工或封閉工地；
    - 暴動或內亂；
    - 不可抗力或天災；
    - 火警或其他賣方所不能控制的意外；
    - 戰爭；或
    - 惡劣天氣。
  - 發展項目的認可人士可以按情況，多於一次批予延後預計關鍵日期以完成發展項目，即收樓日期可能延遲。
  - 條例規定買賣合約須載有強制性條文，列明賣方須於認可人士批予延期後的14日內，向買家提供有關延期證明書的文本。
- 如對收樓日期有任何疑問，可向賣方查詢。

<sup>3</sup> 一般而言，「關鍵日期」指該項目符合批地文件的條件的日期，或該項目在遵照經批准的建築圖則的情況下或按照豁免證明書的發出的條件在各方面均屬完成的日期。有關詳情請參閱條例第2條。



## NOTES TO PURCHASERS OF FIRST-HAND RESIDENTIAL PROPERTIES

### 一手住宅物業買家須知

#### 適用於一手已落成住宅物業

##### 16. 賣方資料表格

- 確保取得最近三個月內印製有關您擬購買的一手已落成住宅物業的「賣方資料表格」。

##### 17. 參觀物業

- 購置住宅物業前，確保已獲安排參觀您打算購置的住宅物業。倘參觀有關物業並非合理地切實可行，則應參觀與有關物業相若的物業，除非您以書面同意賣方無須開放與有關物業相若的物業供您參觀。您應仔細考慮，然後才決定是否簽署豁免上述規定的書面同意。
- 除非有關物業根據租約持有，或為確保物業參觀者的人身安全而須設定合理限制，您可以對該物業進行量度、拍照或拍攝影片。

任何與賣方銷售受條例所規管的一手住宅物業有關的投訴和查詢，請與一手住宅物業銷售監管局聯絡。

網址	: <a href="http://www.srpa.gov.hk">www.srpa.gov.hk</a>
電話	: 2817 3313
電郵	: <a href="mailto:enquiry_srpa@hd.gov.hk">enquiry_srpa@hd.gov.hk</a>
傳真	: 2219 2220

#### 其他相關聯絡資料：

##### 消費者委員會

網址	: <a href="http://www.consumer.org.hk">www.consumer.org.hk</a>
電話	: 2929 2222
電郵	: <a href="mailto:cc@consumer.org.hk">cc@consumer.org.hk</a>
傳真	: 2856 3611

##### 地產代理監管局

網址	: <a href="http://www.eaa.org.hk">www.eaa.org.hk</a>
電話	: 2111 2777
電郵	: <a href="mailto:enquiry@eaa.org.hk">enquiry@eaa.org.hk</a>
傳真	: 2598 9596

##### 香港地產建設商會

電話	: 2826 0111
傳真	: 2845 2521

一手住宅物業銷售監管局  
2023年3月

## INFORMATION ON THE DEVELOPMENT

### 發展項目的資料

#### Name of the Development

Mount Regalia

#### 發展項目名稱

富豪·山峯

#### Name of the street and street number

23 Lai Ping Road

#### 街道名稱及門牌號數

麗坪路23號

#### The Development consists of 7 multi-unit buildings and 24 houses

發展項目包含7幢多單位建築物及24座洋房

#### Total number of storeys of each multi-unit buildings

11 storeys (excluding Basement, Roof and Upper Roof) for each of Tower 1, 2, 3, 5, 6, 7 and 8

#### 每幢多單位建築物的樓層總數

第1, 2, 3, 5, 6, 7 及8座每座 11層 (不包括地庫、天台及上層天台)

#### The floor numbering of each multi-unit buildings

Basement, G/F, 1/F - 3/F, 5/F - 11/F

#### 每幢多單位建築物的樓層號數

地庫、地下、1樓至3樓、5樓至11樓

#### Omitted floor numbers in each multi-unit buildings

4/F

#### 每幢多單位建築物內被略去的樓層號數

不設4樓

#### Refuge floor of each multi-unit building

No refuge floor

#### 每幢多單位建築物內的庇護層

不設庇護層

#### Total number of houses

24

#### 洋房總數

24座

#### House Number

House 1	House 16
House 2	House 17
House 3	House 18
House 5	House 19
House 6	House 20
House 7	House 21
House 8	House 22
House 9	House 23
House 10	House 25
House 11	House 26
House 12	House 27
House 15	House 28

#### 洋房號碼

1 號洋房	16 號洋房
2 號洋房	17 號洋房
3 號洋房	18 號洋房
5 號洋房	19 號洋房
6 號洋房	20 號洋房
7 號洋房	21 號洋房
8 號洋房	22 號洋房
9 號洋房	23 號洋房
10 號洋房	25 號洋房
11 號洋房	26 號洋房
12 號洋房	27 號洋房
15 號洋房	28 號洋房

#### Omitted house numbers

House 4, House 13, House 14 and House 24

#### 被略去的洋房編號

4號洋房, 13號洋房, 14號洋房及24號洋房



## INFORMATION ON VENDOR AND OTHERS INVOLVED IN THE DEVELOPMENT

### 賣方及有參與發展項目的其他人的資料

#### Vendor

Eminent Gold Investments Limited

#### Holding companies of the vendor

Rimmel Holdings Limited  
P&R Holdings Limited  
Paliburg Development BVI Holdings Limited  
Paliburg Holdings Limited  
Century City BVI Holdings Limited  
Century City International Holdings Limited

#### Authorized person for the Development

Mr. Chan Ka Keung

#### The firm or corporation of which an authorized person for the Development is a proprietor, director or employee in his or her professional capacity

Paliburg Development Consultants Limited

#### Building contractor for the Development

Sunnic Engineering Limited

#### The firm of solicitors acting for the owner in relation to the sale of residential properties in the Development

Mayer Brown  
Iu, Lai & Li Solicitors & Notaries

#### Authorized institutions that have made a loan, or has undertaken to provide finance, for the construction of the Development

Australia and New Zealand Banking Group Limited (the loan had been assigned to other authorized institution(s)), The Hongkong and Shanghai Banking Corporation Limited (the loan had been assigned to other authorized institution(s)), Hang Seng Bank Limited (the loan had been assigned to other authorized institution(s)), Bank of Communications Co., Ltd. Hong Kong Branch (the loan had been assigned to other authorized institution(s)), Cathay United Bank Company, Limited, Hong Kong Branch (the loan had been assigned to other authorized institution(s)), Standard Chartered Bank (Hong Kong) Limited (the loan had been assigned to other authorized institution(s)), China CITIC Bank International Limited, Nanyang Commercial Bank, Limited, Bank of Communications (Hong Kong) Limited, China Everbright Bank Co., Ltd., Hong Kong Branch, Chiyu Banking Corporation Limited, The Bank of East Asia, Limited

#### Any other person who has made a loan for the construction of the Development

Rimmel Holdings Limited

#### 賣方

Eminent Gold Investments Limited

#### 賣方的控權公司

Rimmel Holdings Limited  
P&R Holdings Limited 百富控股有限公司  
Paliburg Development BVI Holdings Limited  
Paliburg Holdings Limited  
Century City BVI Holdings Limited  
Century City International Holdings Limited

#### 發展項目的認可人士

陳家強先生

#### 發展項目的認可人士以其專業身分擔任經營人、董事或僱員的商號或法團

百利保發展顧問有限公司

#### 發展項目的承建商

實力工程有限公司

#### 就發展項目中的住宅物業的出售而代表擁有人行事的律師事務所

孖士打律師行  
姚黎李律師行

#### 已為發展項目的建造提供貸款或已承諾為該項建造提供融資的認可機構

澳新銀行集團有限公司(貸款已轉移至其他認可機構)，香港上海滙豐銀行有限公司(貸款已轉移至其他認可機構)，恆生銀行有限公司(貸款已轉移至其他認可機構)，交通銀行股份有限公司香港分行(貸款已轉移至其他認可機構)，國泰世華商業銀行股份有限公司香港分行(貸款已轉移至其他認可機構)，渣打銀行(香港)有限公司(貸款已轉移至其他認可機構)，中信銀行(國際)有限公司，南洋商業銀行有限公司，交通銀行(香港)有限公司，中國光大銀行股份有限公司香港分行，集友銀行有限公司，東亞銀行有限公司

#### 已為發展項目的建造提供貸款的任何其他人

Rimmel Holdings Limited

## RELATIONSHIP BETWEEN PARTIES INVOLVED IN THE DEVELOPMENT

### 有參與發展項目的各方的關係

(a)	The vendor or a building contractor for the Development is an individual, and that vendor or contractor is an immediate family member of an authorized person for the Development; 賣方或有關發展項目的承建商屬個人，並屬該項目的認可人士的家人；	Not applicable 不適用
(b)	The vendor or a building contractor for the Development is a partnership, and a partner of that vendor or contractor is an immediate family member of such an authorized person; 賣方或該項目的承建商屬合夥，而該賣方或承建商的合夥人屬上述認可人士的家人；	Not applicable 不適用
(c)	The vendor or a building contractor for the Development is a corporation, and a director or the secretary of that vendor or contractor (or a holding company of that vendor) is an immediate family member of such an authorized person; 賣方或該項目的承建商屬法團，而該賣方或承建商（或該賣方的控權公司）的董事或秘書屬上述認可人士的家人；	No 否
(d)	The vendor or a building contractor for the Development is an individual, and that vendor or contractor is an immediate family member of an associate of such an authorized person; 賣方或該項目的承建商屬個人，並屬上述認可人士的有聯繫人士的家人；	Not applicable 不適用
(e)	The vendor or a building contractor for the Development is a partnership, and a partner of that vendor or contractor is an immediate family member of an associate of such an authorized person; 賣方或該項目的承建商屬合夥，而該賣方或承建商的合夥人屬上述認可人士的有聯繫人士的家人；	Not applicable 不適用
(f)	The vendor or a building contractor for the Development is a corporation, and a director or the secretary of that vendor or contractor (or a holding company of that vendor) is an immediate family member of an associate of such an authorized person; 賣方或該項目的承建商屬法團，而該賣方或承建商（或該賣方的控權公司）的董事或秘書屬上述認可人士的有聯繫人士的家人；	No 否
(g)	The vendor or a building contractor for the Development is an individual, and that vendor or contractor is an immediate family member of a proprietor of a firm of solicitors acting for the owner in relation to the sale of residential properties in the Development; 賣方或該項目的承建商屬個人，並屬就該項目內的住宅物業的出售代表擁有人行事的律師事務所行事的經營人的家人；	Not applicable 不適用
(h)	The vendor or a building contractor for the Development is a partnership, and a partner of that vendor or contractor is an immediate family member of a proprietor of a firm of solicitors acting for the owner in relation to the sale of residential properties in the Development; 賣方或該項目的承建商屬合夥，而該賣方或承建商的合夥人屬就該項目內的住宅物業的出售代表擁有人行事的律師事務所行事的經營人的家人；	Not applicable 不適用
(i)	The vendor or a building contractor for the Development is a corporation, and a director or the secretary of that vendor or contractor (or a holding company of that vendor) is an immediate family member of a proprietor of such a firm of solicitors; 賣方或該項目的承建商屬法團，而該賣方或承建商（或該賣方的控權公司）的董事或秘書屬上述律師事務所的經營人的家人；	No 否
(j)	The vendor, a holding company of the vendor, or a building contractor for the Development, is a private company, and an authorized person for the Development, or an associate of such an authorized person, holds at least 10% of the issued shares in that vendor, holding company or contractor; 賣方、賣方的控權公司或有關發展項目的承建商屬私人公司，而該項目的認可人士或該認可人士的有聯繫人士持有該賣方、控權公司或承建商最少10%的已發行股份；	No 否
(k)	The vendor, a holding company of the vendor, or a building contractor for the Development, is a listed company, and such an authorized person, or such an associate, holds at least 1% of the issued shares in that vendor, holding company or contractor; 賣方、賣方的控權公司或該項目的承建商屬上市公司，而上述認可人士或上述有聯繫人士持有該賣方、控權公司或承建商最少1%的已發行股份；	Insofar as such an authorized person is concerned: No 就上述認可人士而言：否  Insofar as an associate of such an authorized person is concerned: Not Applicable 就上述認可人士的有聯繫人士而言：不適用
(l)	The vendor or a building contractor for the Development is a corporation, and such an authorized person, or such an associate, is an employee, director or secretary of that vendor or contractor or of a holding company of that vendor; 賣方或該項目的承建商屬法團，而上述認可人士或上述有聯繫人士屬該賣方、承建商或該賣方的控權公司的僱員、董事或秘書；	Insofar as such an authorized person is concerned: No 就上述認可人士而言：否  Insofar as an associate of such an authorized person is concerned: Not Applicable 就上述認可人士的有聯繫人士而言：不適用

## RELATIONSHIP BETWEEN PARTIES INVOLVED IN THE DEVELOPMENT

### 有參與發展項目的各方的關係

(m)	The vendor or a building contractor for the Development is a partnership, and such an authorized person, or such an associate, is an employee of that vendor or contractor; 賣方或該項目的承建商屬合夥，而上述認可人士或上述有聯繫人士屬該賣方或承建商的僱員；	Not applicable 不適用
(n)	The vendor, a holding company of the vendor, or a building contractor for the Development, is a private company, and a proprietor of a firm of solicitors acting for the owner in relation to the sale of residential properties in the Development holds at least 10% of the issued shares in that vendor, holding company or contractor; 賣方、賣方的控權公司或該項目的承建商屬私人公司，而就該項目中的住宅物業的出售而代表擁有人行事的律師事務所的經營人持有該賣方、控權公司或承建商最少10%的已發行股份；	No 否
(o)	The vendor, a holding company of the vendor, or a building contractor for the Development, is a listed company, and a proprietor of such a firm of solicitors holds at least 1% of the issued shares in that vendor, holding company or contractor; 賣方、賣方的控權公司或該項目的承建商屬上市公司，而上述律師事務所的經營人持有該賣方、控權公司或承建商最少1%的已發行股份；	No 否
(p)	The vendor or a building contractor for the Development is a corporation, and a proprietor of such a firm of solicitors is an employee, director or secretary of that vendor or contractor or of a holding company of that vendor; 賣方或該項目的承建商屬法團，而上述律師事務所的經營人屬該賣方或承建商或該賣方的控權公司的僱員、董事或秘書；	No 否
(q)	The vendor or a building contractor for the Development is a partnership, and a proprietor of such a firm of solicitors is an employee of that vendor or contractor; 賣方或該項目的承建商屬合夥，而上述律師事務所的經營人屬該賣方或承建商的僱員；	Not applicable 不適用
(r)	The vendor or a building contractor for the Development is a corporation, and the corporation of which an authorized person for the Development is a director or employee in his or her professional capacity is an associate corporation of that vendor or contractor or of a holding company of that vendor; 賣方或該項目的承建商屬法團，而該項目的認可人士以其專業身分擔任董事或僱員的法團為該賣方或承建商或該賣方的控權公司的有聯繫法團；	The corporation of which the authorized person (Mr. Chan Ka Keung) is an employee in his professional capacity is an associate corporation of the vendor (Eminent Gold Investments Limited) and four of its holding companies (Paliburg Development BVI Holdings Limited, Paliburg Holdings Limited, Century City International Holdings Limited and Century City BVI Holdings Limited). 認可人士（陳家強先生）以其專業身份擔任僱員的法團為賣方 (Eminent Gold Investments Limited) 及其四間控權公司 (Paliburg Development BVI Holdings Limited, Paliburg Holdings Limited, Century City International Holdings Limited 及 Century City BVI Holdings Limited) 的有聯繫法團。
(s)	The vendor or a building contractor for the Development is a corporation, and that contractor is an associate corporation of that vendor or of a holding company of that vendor. 賣方或該項目的承建商屬法團，而該承建商屬該賣方或該賣方的控權公司的有聯繫法團。	No 否

## INFORMATION ON DESIGN OF THE DEVELOPMENT

### 發展項目的設計的資料

#### There are non-structural prefabricated external walls and curtain walls forming part of the enclosing walls of the Development

發展項目有構成圍封牆的一部分的非結構的預製外牆及幕牆

The Range of Thickness of the Non-Structural Prefabricated External Walls of Each House: 150mm.

每幢洋房的非結構的預製外牆的厚度範圍：150毫米。

#### Schedule of Total Area of Non-Structural Prefabricated External Walls Forming Part of The Enclosing Walls (Houses)

構成圍封牆的一部分的非結構的預製外牆總面積表 (洋房)

House 洋房	Total area of the non-structural prefabricated external walls of each residential property (sq.m) 每個住宅物業的非結構的預製外牆總面積(平方米)
House 1 1號洋房	3.754
House 2 2號洋房	3.754
House 3 3號洋房	3.754
House 5 5號洋房	3.754
House 6 6號洋房	3.754
House 7 7號洋房	3.754
House 8 8號洋房	0.000
House 9 9號洋房	0.000
House 10 10號洋房	0.000
House 11 11號洋房	1.092
House 12 12號洋房	1.599

House 洋房	Total area of the non-structural prefabricated external walls of each residential property (sq.m) 每個住宅物業的非結構的預製外牆總面積(平方米)
House 15 15號洋房	3.066
House 16 16號洋房	3.066
House 17 17號洋房	3.066
House 18 18號洋房	3.066
House 19 19號洋房	3.066
House 20 20號洋房	3.066
House 21 21號洋房	3.066
House 22 22號洋房	3.066
House 23 23號洋房	0.000
House 25 25號洋房	3.518
House 26 26號洋房	3.518
House 27 27號洋房	3.518
House 28 28號洋房	3.518

## INFORMATION ON DESIGN OF THE DEVELOPMENT

### 發展項目的設計的資料

The Range of Thickness of the Non-Structural Prefabricated External Walls of Each Tower: 150mm.

每幢大樓的非結構的預製外牆的厚度範圍：150毫米。

#### Schedule of Total Area of Non-Structural Prefabricated External Walls Forming Part of The Enclosing Walls (Towers)

##### 構成圍封牆的一部分的非結構的預製外牆總面積表 (大樓)

Tower 座	Floor 樓層	Flat 單位	Total area of the non-structural prefabricated external walls of each residential property (sq.m) 每個住宅物業的非結構的預製外牆總面積(平方米)
1	G/F - 1/F 地下至1樓	Garden Duplex	0.000
	1/F 1樓	• Terrace Apartment	0.885
	2/F - 3/F & 5/F - 10/F 2樓至3樓及 5樓至10樓	A	0.885
	2/F - 3/F & 5/F - 9/F 2樓至3樓及 5樓至9樓	B	0.885
	10/F 10樓	B	0.885
	11/F 11樓	Sky Pool Penthouse	1.331
	2	G/F 地下	• Garden Apartment
G/F - 1/F 地下至1樓		Garden Duplex	0.625
1/F 1樓		B	0.625
2/F - 3/F & 5/F - 9/F 2樓至3樓及 5樓至9樓		A	0.625
		B	0.625
10/F - 11/F 10樓至11樓		Spa Duplex A	1.249
		Spa Duplex B	1.249

Tower 座	Floor 樓層	Flat 單位	Total area of the non-structural prefabricated external walls of each residential property (sq.m) 每個住宅物業的非結構的預製外牆總面積(平方米)
3	G/F 地下	• Garden Apartment	0.469
	G/F - 1/F 地下至1樓	Garden Duplex	0.000
	1/F 1樓	B	0.885
	2/F - 3/F & 5/F - 9/F 2樓至3樓及 5樓至9樓	A	0.885
	2/F - 3/F & 5/F - 10/F 2樓至3樓及 5樓至10樓	B	0.885
	10/F 10樓	A	0.885
	11/F 11樓	Sky Pool Penthouse	1.331
	5	1/F 1樓	A
B			1.009
2/F - 3/F & 5/F - 10/F 2樓至3樓及 5樓至10樓		A	1.009
		B	1.009
11/F 11樓		Sky Pool Penthouse	2.018

Note:

• “Terrace Apartment”, “Garden Apartment” and “Courtyard Penthouse” are names for marketing purposes only and will not appear in any Deed of Mutual Covenant, the Preliminary Agreement for Sale and Purchase, Agreement for Sale and Purchase, Assignment, or any other title deeds and documents relating to the Development. The names as appearing on the approved building plans are: Flat A on 1/F of Tower 1 for Terrace Apartment on 1/F of Tower 1; Flat B on G/F of Tower 2 for Garden Apartment on G/F of Tower 2; Flat B on G/F of Tower 3 for Garden Apartment on G/F of Tower 3; Flat A on G/F of Tower 7 for Garden Apartment on G/F of Tower 7; Penthouse on 11/F of Tower 7 for Courtyard Penthouse on 11/F of Tower 7; Flat B on G/F of Tower 8 for Garden Apartment on G/F of Tower 8; Penthouse on 11/F of Tower 8 for Courtyard Penthouse on 11/F of Tower 8.

備註：

• 「Terrace Apartment」、「Garden Apartment」及「Courtyard Penthouse」僅為市場推廣之用的名稱，並不會於關於發展項目的任何公契、臨時買賣合約、買賣合約、轉讓契及契據出現。經批准的建築圖則上顯示的名稱為：第1座1樓A單位（即第1座1樓Terrace Apartment）；第2座地下B單位（即第2座地下Garden Apartment）；第3座地下B單位（即第3座地下Garden Apartment）；第7座地下A單位（即第7座地下Garden Apartment）；第7座11樓Penthouse（即第7座11樓Courtyard Penthouse）；第8座地下B單位（即第8座地下Garden Apartment）；第8座11樓Penthouse（即第8座11樓Courtyard Penthouse）。



## INFORMATION ON DESIGN OF THE DEVELOPMENT

### 發展項目的設計的資料

Tower 座	Floor 樓層	Flat 單位	Total area of the non-structural prefabricated external walls of each residential property (sq.m) 每個住宅物業的非結構的預製外牆總面積(平方米)
6	1/F 1樓	A	1.009
		B	1.009
	2/F - 3/F & 5/F - 10/F 2樓至3樓及 5樓至10樓	A	1.009
		B	1.009
	11/F 11樓	Sky Pool Penthouse	2.018
7	G/F 地下	• Garden Apartment	0.866
	1/F 1樓	A	1.009
		B	1.009
	2/F - 3/F & 5/F - 10/F 2樓至3樓及 5樓至10樓	A	1.009
		B	1.009
11/F 11樓	• Courtyard Penthouse	2.018	
8	G/F 地下	• Garden Apartment	0.886
	1/F 1樓	A	1.009
		B	1.009
	2/F - 3/F & 5/F - 10/F 2樓至3樓及 5樓至10樓	A	1.009
		B	1.009
11/F 11樓	• Courtyard Penthouse	2.018	

Note:

• “Terrace Apartment”, “Garden Apartment” and “Courtyard Penthouse” are names for marketing purposes only and will not appear in any Deed of Mutual Covenant, the Preliminary Agreement for Sale and Purchase, Agreement for Sale and Purchase, Assignment, or any other title deeds and documents relating to the Development. The names as appearing on the approved building plans are: Flat A on 1/F of Tower 1 for Terrace Apartment on 1/F of Tower 1; Flat B on G/F of Tower 2 for Garden Apartment on G/F of Tower 2; Flat B on G/F of Tower 3 for Garden Apartment on G/F of Tower 3; Flat A on G/F of Tower 7 for Garden Apartment on G/F of Tower 7; Penthouse on 11/F of Tower 7 for Courtyard Penthouse on 11/F of Tower 7; Flat B on G/F of Tower 8 for Garden Apartment on G/F of Tower 8; Penthouse on 11/F of Tower 8 for Courtyard Penthouse on 11/F of Tower 8.

備註：

• 「Terrace Apartment」、「Garden Apartment」及「Courtyard Penthouse」僅為市場推廣之用的名稱，並不會於關於發展項目的任何公契、臨時買賣合約、買賣合約、轉讓契及契據出現。經批准的建築圖則上顯示的名稱為：第1座1樓A單位（即第1座1樓Terrace Apartment）；第2座地下B單位（即第2座地下Garden Apartment）；第3座地下B單位（即第3座地下Garden Apartment）；第7座地下A單位（即第7座地下Garden Apartment）；第7座11樓Penthouse（即第7座11樓Courtyard Penthouse）；第8座地下B單位（即第8座地下Garden Apartment）；第8座11樓Penthouse（即第8座11樓Courtyard Penthouse）。

## INFORMATION ON DESIGN OF THE DEVELOPMENT

### 發展項目的設計的資料

The Range of Thickness of the Curtain Walls of Each House: 300mm.

每幢洋房的非結構的幕牆的厚度範圍：300毫米。

#### Schedule of Total Area of Curtain Walls Forming Part of The Enclosing Walls (Houses)

##### 構成圍封牆的一部分的幕牆總面積表(洋房)

House 洋房	Total area of Curtain walls of each residential property (sq.m) 每個住宅物業的幕牆的總面積(平方米)
House 1 1號洋房	4.329
House 2 2號洋房	4.329
House 3 3號洋房	4.329
House 5 5號洋房	4.329
House 6 6號洋房	4.329
House 7 7號洋房	4.329
House 8 8號洋房	5.811
House 9 9號洋房	5.811
House 10 10號洋房	5.811
House 11 11號洋房	8.407
House 12 12號洋房	9.786
House 15 15號洋房	5.979
House 16 16號洋房	5.979

House 洋房	Total area of Curtain walls of each residential property (sq.m) 每個住宅物業的幕牆的總面積(平方米)
House 17 17號洋房	5.979
House 18 18號洋房	5.979
House 19 19號洋房	5.979
House 20 20號洋房	5.979
House 21 21號洋房	5.979
House 22 22號洋房	5.979
House 23 23號洋房	7.119
House 25 25號洋房	5.574
House 26 26號洋房	5.574
House 27 27號洋房	5.574
House 28 28號洋房	5.574

## INFORMATION ON DESIGN OF THE DEVELOPMENT

### 發展項目的設計的資料

The Range of Thickness of the Curtain Walls of Each Tower: 300mm.

每幢大樓的非結構的幕牆的厚度範圍：300毫米。

#### Schedule of Total Area of Curtain Walls Forming Part of The Enclosing Walls (Towers)

##### 構成圍封牆的一部分的幕牆總面積表(大樓)

Tower 座	Floor 樓層	Flat 單位	Total area of Curtain walls of each residential property (sq.m) 每個住宅物業的幕牆的總面積(平方米)
1	G/F - 1/F 地下至1樓	Garden Duplex	8.550
	1/F 1樓	• Terrace Apartment	6.617
	2/F - 3/F & 5/F - 10/F 2樓至3樓及 5樓至10樓	A	8.280
	2/F - 3/F & 5/F - 10/F 2樓至3樓及 5樓至10樓	B	7.410
	11/F 11樓	Sky Pool Penthouse	10.269
	2	G/F 地下	• Garden Apartment
G/F - 1/F 地下至1樓		Garden Duplex	9.827
1/F 1樓		B	6.638
2/F - 3/F & 5/F - 9/F 2樓至3樓及 5樓至9樓		A	7.395
		B	7.395
10/F - 11/F 10樓至11樓		Spa Duplex A	15.888
		Spa Duplex B	15.888

Tower 座	Floor 樓層	Flat 單位	Total area of Curtain walls of each residential property (sq.m) 每個住宅物業的幕牆的總面積(平方米)
3	G/F 地下	• Garden Apartment	6.303
	G/F - 1/F 地下至1樓	Garden Duplex	8.379
	1/F 1樓	B	7.408
	2/F - 3/F & 5/F - 9/F 2樓至3樓及 5樓至9樓	A	7.410
	2/F - 3/F & 5/F - 10/F 2樓至3樓及 5樓至10樓	B	8.280
	10/F 10樓	A	7.410
	11/F 11樓	Sky Pool Penthouse	10.269
5	1/F 1樓	A	4.798
		B	4.484
	2/F - 3/F & 5/F - 10/F 2樓至3樓及 5樓至10樓	A	4.949
		B	4.484
	11/F 11樓	Sky Pool Penthouse	5.959

Note:

• “Terrace Apartment”, “Garden Apartment” and “Courtyard Penthouse” are names for marketing purposes only and will not appear in any Deed of Mutual Covenant, the Preliminary Agreement for Sale and Purchase, Agreement for Sale and Purchase, Assignment, or any other title deeds and documents relating to the Development. The names as appearing on the approved building plans are: Flat A on 1/F of Tower 1 for Terrace Apartment on 1/F of Tower 1; Flat B on G/F of Tower 2 for Garden Apartment on G/F of Tower 2; Flat B on G/F of Tower 3 for Garden Apartment on G/F of Tower 3; Flat A on G/F of Tower 7 for Garden Apartment on G/F of Tower 7; Penthouse on 11/F of Tower 7 for Courtyard Penthouse on 11/F of Tower 7; Flat B on G/F of Tower 8 for Garden Apartment on G/F of Tower 8; Penthouse on 11/F of Tower 8 for Courtyard Penthouse on 11/F of Tower 8.

備註：

• 「Terrace Apartment」、「Garden Apartment」及「Courtyard Penthouse」僅為市場推廣之用的名稱，並不會於關於發展項目的任何公契、臨時買賣合約、買賣合約、轉讓契及契據出現。經批准的建築圖則上顯示的名稱為：第1座1樓A單位（即第1座1樓Terrace Apartment）；第2座地下B單位（即第2座地下Garden Apartment）；第3座地下B單位（即第3座地下Garden Apartment）；第7座地下A單位（即第7座地下Garden Apartment）；第7座11樓Penthouse（即第7座11樓Courtyard Penthouse）；第8座地下B單位（即第8座地下Garden Apartment）；第8座11樓Penthouse（即第8座11樓Courtyard Penthouse）。



## INFORMATION ON DESIGN OF THE DEVELOPMENT

### 發展項目的設計的資料

Tower 座	Floor 樓層	Flat 單位	Total area of Curtain walls of each residential property (sq.m) 每個住宅物業的幕牆的總面積(平方米)
6	1/F 1樓	A	4.484
		B	4.319
	2/F - 3/F & 5/F - 10/F 2樓至3樓及 5樓至10樓	A	4.484
		B	4.949
	11/F 11樓	Sky Pool Penthouse	5.959
7	G/F 地下	• Garden Apartment	3.879
	1/F 1樓	A	5.099
		B	4.319
	2/F - 3/F & 5/F - 10/F 2樓至3樓及 5樓至10樓	A	5.099
		B	4.949
11/F 11樓	• Courtyard Penthouse	7.115	
8	G/F 地下	• Garden Apartment	3.879
	1/F 1樓	A	4.319
		B	5.099
	2/F - 3/F & 5/F - 10/F 2樓至3樓及 5樓至10樓	A	4.949
		B	5.099
11/F 11樓	• Courtyard Penthouse	7.115	

Note:

• “Terrace Apartment”, “Garden Apartment” and “Courtyard Penthouse” are names for marketing purposes only and will not appear in any Deed of Mutual Covenant, the Preliminary Agreement for Sale and Purchase, Agreement for Sale and Purchase, Assignment, or any other title deeds and documents relating to the Development. The names as appearing on the approved building plans are: Flat A on 1/F of Tower 1 for Terrace Apartment on 1/F of Tower 1; Flat B on G/F of Tower 2 for Garden Apartment on G/F of Tower 2; Flat B on G/F of Tower 3 for Garden Apartment on G/F of Tower 3; Flat A on G/F of Tower 7 for Garden Apartment on G/F of Tower 7; Penthouse on 11/F of Tower 7 for Courtyard Penthouse on 11/F of Tower 7; Flat B on G/F of Tower 8 for Garden Apartment on G/F of Tower 8; Penthouse on 11/F of Tower 8 for Courtyard Penthouse on 11/F of Tower 8.

備註:

• 「Terrace Apartment」、「Garden Apartment」及「Courtyard Penthouse」僅為市場推廣之用的名稱，並不會於關於發展項目的任何公契、臨時買賣合約、買賣合約、轉讓契及契據出現。經批准的建築圖則上顯示的名稱為：第1座1樓A單位（即第1座1樓Terrace Apartment）；第2座地下B單位（即第2座地下Garden Apartment）；第3座地下B單位（即第3座地下Garden Apartment）；第7座地下A單位（即第7座地下Garden Apartment）；第7座11樓Penthouse（即第7座11樓Courtyard Penthouse）；第8座地下B單位（即第8座地下Garden Apartment）；第8座11樓Penthouse（即第8座11樓Courtyard Penthouse）。

## INFORMATION ON PROPERTY MANAGEMENT

### 物業管理的資料

**The Manager appointed under the latest draft deed of mutual covenant**  
Regal Estate Management Limited

根據公契的最新擬稿所委任的管理人  
富豪物業管理有限公司

# LOCATION PLAN OF THE DEVELOPMENT

## 發展項目的所在位置圖

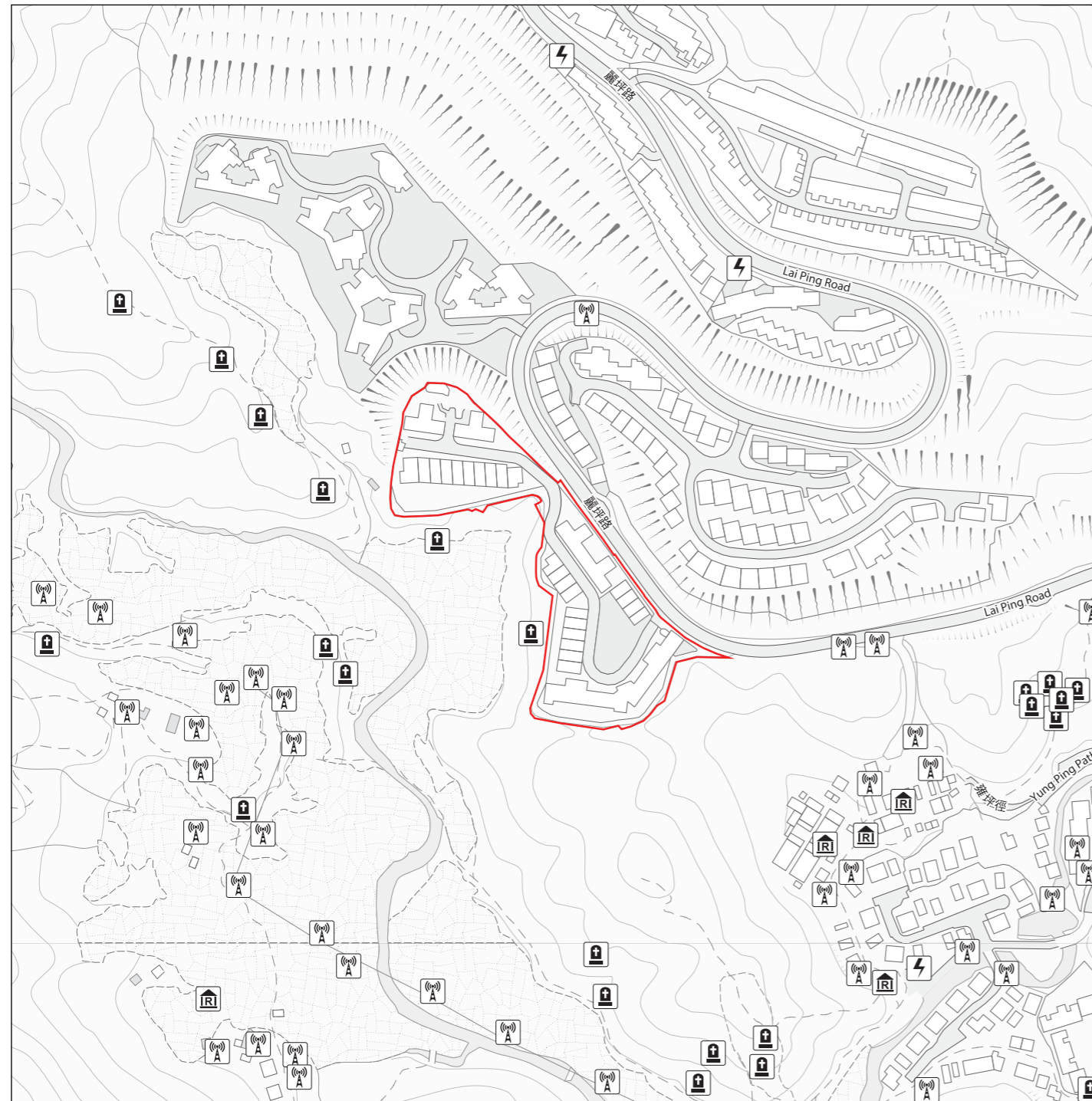

N  
Scale: 0M/米 250M/米  
比例:

Boundary of the Development  
發展項目邊界

The Map are provided by the CSDI Portal and intellectual property rights are owned by the Government of the HKSAR.  
地圖由空間數據共享平台提供，香港特別行政區政府為知識產權擁有人。

This location plan is prepared by the vendor with reference to the Digital Topographic Map Nos. T7-NE-C dated 15 February 2024 and T7-SE-A dated 15 February 2024 from Survey and Mapping Office of the Lands Department, with adjustments where necessary.

此位置圖是由賣方擬備並參考地政總署測繪處於2024年2月15日出版之數碼地形圖，圖幅編號T7-NE-C及於2024年2月15日出版之數碼地形圖，圖幅編號T7-SE-A，有需要處經修正處理。

### Notation 圖例

- Power Plant (including Electricity Sub-stations)  
發電廠(包括電力分站)
- Cemetery  
墳場
- Religious Institution (including Church, Temple and Tsz Tong)  
宗教場所(包括教堂、廟宇及祠堂)
- Public Utility Installation  
公用事業設施裝置

### Notes:

1. The vendor advises prospective purchasers to conduct an on-site visit for a better understanding of the development site, its surrounding environment and the public facilities nearby.
2. The location plan may show more than the area required under the Residential Properties (First-hand Sales) Ordinance due to the technical reason that the boundary of the Development is irregular.

### 備註：

1. 賣方建議準買家到有關發展地盤作實地考察，以對該發展地盤、其周邊地區環境及附近的公共設施有較佳了解。
2. 由於發展項目的邊界不規則的技術原因，此位置圖所顯示的範圍可能超過《一手住宅物業銷售條例》所規定的範圍。

## AERIAL PHOTOGRAPH OF THE DEVELOPMENT

### 發展項目的鳥瞰照片

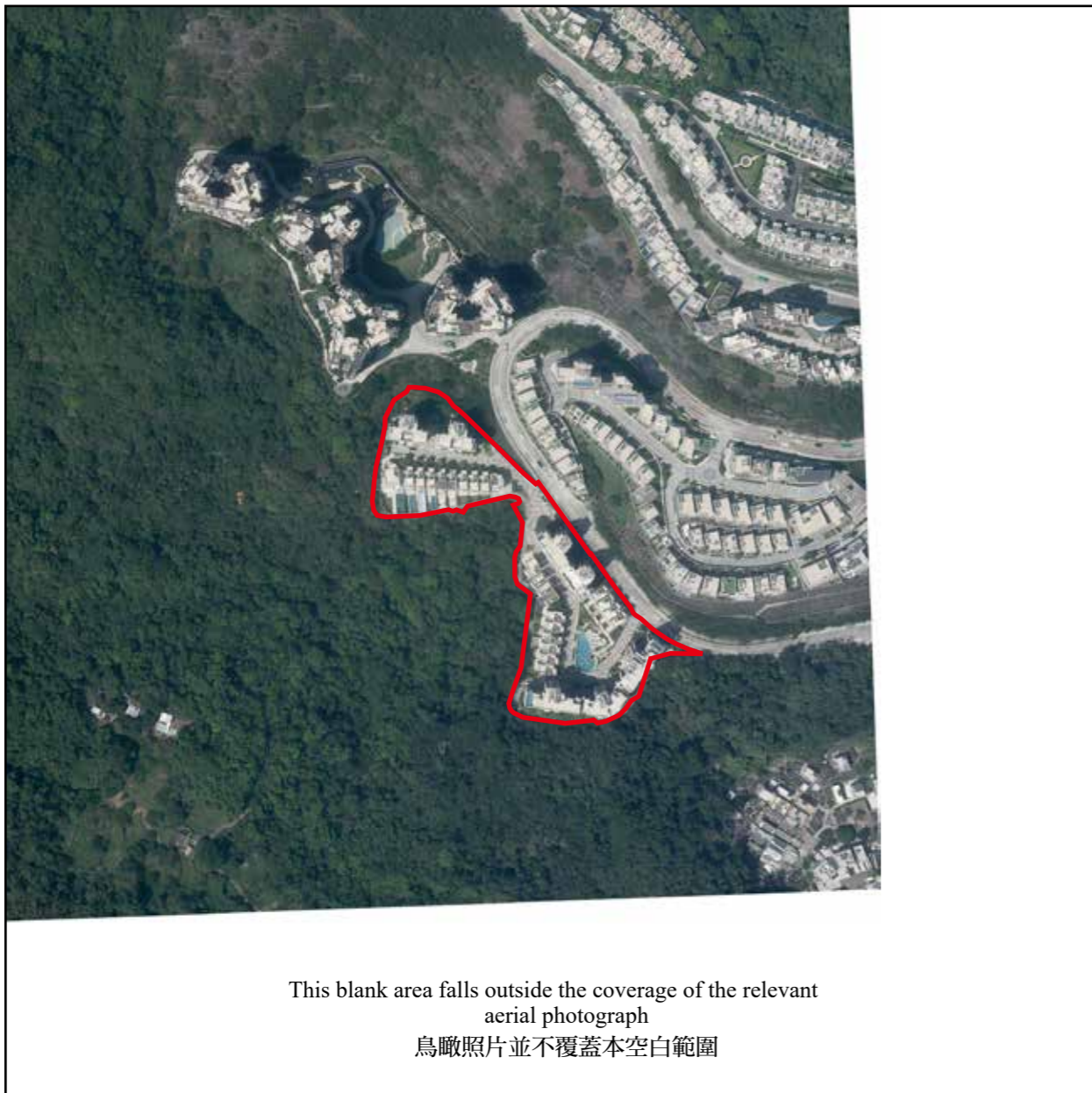

Adopted from part of the aerial photograph taken by the Survey and Mapping Office of the Lands Department at a flying height of 6,900 feet, Photo No. E162481C, dated 8 April 2022.

摘錄自地政總署測繪處在6,900呎的飛行高度拍攝之鳥瞰照片，照片編號E162481C，飛行日期：2022年4月8日。

#### Notes:

1. Copy of the aerial photograph of the Development is available for free inspection at the sales office during opening hours.
2. The aerial photograph may show more than the area required under the Residential Properties (First-hand Sales) Ordinance due to the technical reason that the boundary of the Development is irregular.

#### 備註：

1. 發展項目的鳥瞰照片之副本可於售樓處開放時間內免費查閱。
2. 由於發展項目的邊界不規則的技術原因，此鳥瞰照片所顯示的範圍可能超過《一手住宅物業銷售條例》所規定的範圍。

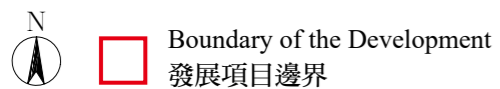

Survey and Mapping Office, Lands Department, The Government of HKSAR © Copyright reserved – reproduction by permission only.

香港特別行政區政府地政總署測繪處 © 版權所有，未經許可，不得翻印。



## AERIAL PHOTOGRAPH OF THE DEVELOPMENT

### 發展項目的鳥瞰照片



Adopted from part of the aerial photograph taken by the Survey and Mapping Office of the Lands Department at a flying height of 6,900 feet, Photo No. E162483C, dated 8 April 2022.

摘錄自地政總署測繪處在6,900呎的飛行高度拍攝之鳥瞰照片，照片編號E162483C，飛行日期：2022年4月8日。

#### Notes:

1. Copy of the aerial photograph of the Development is available for free inspection at the sales office during opening hours.
2. The aerial photograph may show more than the area required under the Residential Properties (First-hand Sales) Ordinance due to the technical reason that the boundary of the Development is irregular.

#### 備註：

1. 發展項目的鳥瞰照片之副本可於售樓處開放時間內免費查閱。
2. 由於發展項目的邊界不規則的技術原因，此鳥瞰照片所顯示的範圍可能超過《一手住宅物業銷售條例》所規定的範圍。

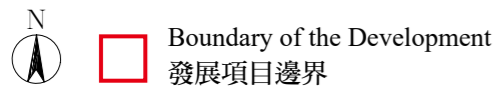

Survey and Mapping Office, Lands Department, The Government of HKSAR © Copyright reserved – reproduction by permission only.

香港特別行政區政府地政總署測繪處 © 版權所有，未經許可，不得翻印。

## AERIAL PHOTOGRAPH OF THE DEVELOPMENT

### 發展項目的鳥瞰照片

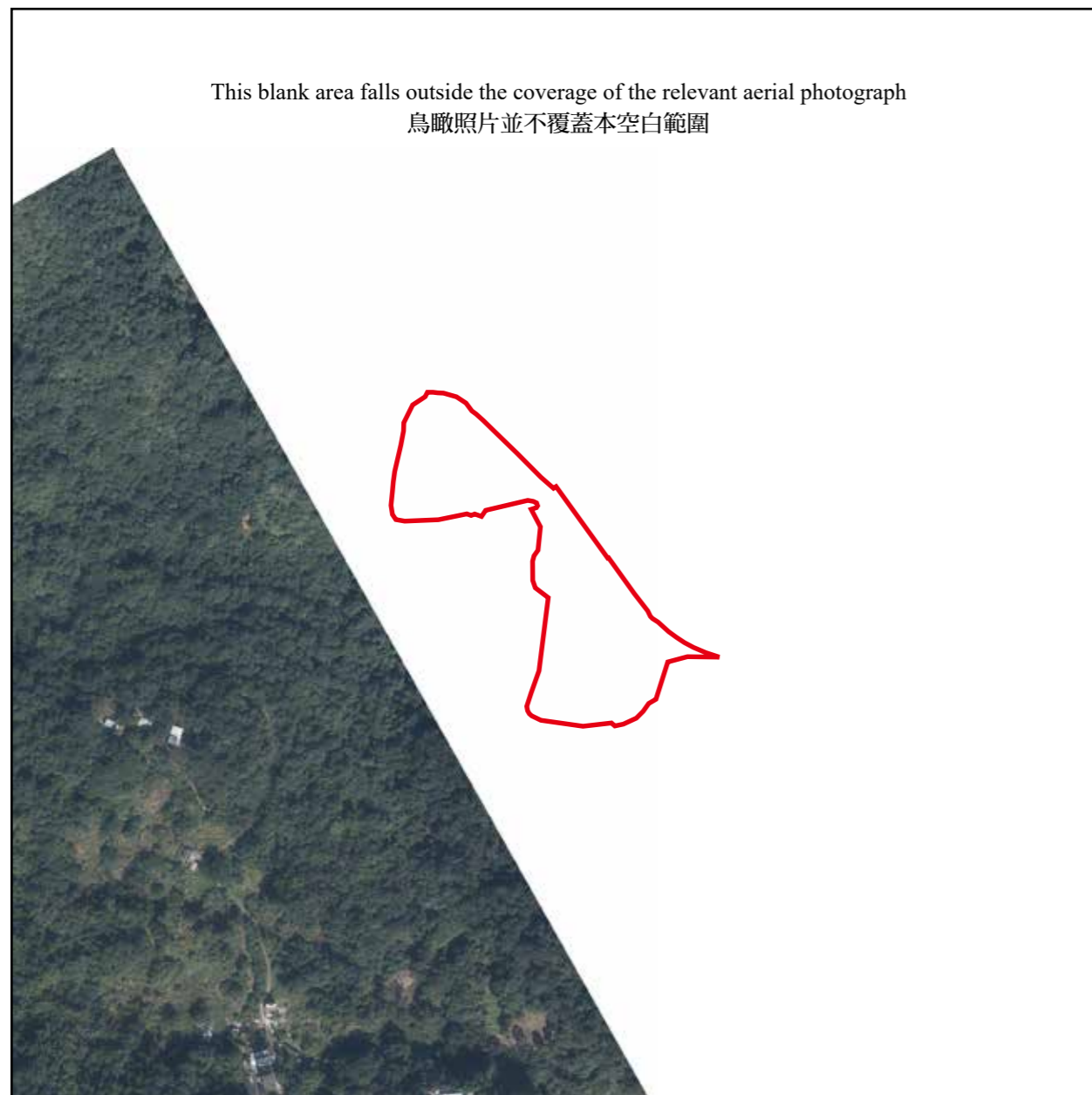

Adopted from part of the aerial photograph taken by the Survey and Mapping Office of the Lands Department at a flying height of 6,900 feet, Photo No. E173173C, dated 18 December 2022.

摘錄自地政總署測繪處在6,900呎的飛行高度拍攝之鳥瞰照片，照片編號E173173C，飛行日期：2022年12月18日。

#### Notes:

1. Copy of the aerial photograph of the Development is available for free inspection at the sales office during opening hours.
2. The aerial photograph may show more than the area required under the Residential Properties (First-hand Sales) Ordinance due to the technical reason that the boundary of the Development is irregular.

#### 備註：

1. 發展項目的鳥瞰照片之副本可於售樓處開放時間內免費查閱。
2. 由於發展項目的邊界不規則的技術原因，此鳥瞰照片所顯示的範圍可能超過《一手住宅物業銷售條例》所規定的範圍。

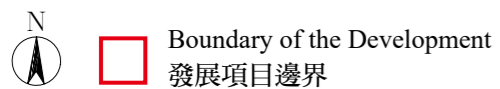

Survey and Mapping Office, Lands Department, The Government of HKSAR © Copyright reserved – reproduction by permission only.

香港特別行政區政府地政總署測繪處 © 版權所有，未經許可，不得翻印。

## AERIAL PHOTOGRAPH OF THE DEVELOPMENT

### 發展項目的鳥瞰照片

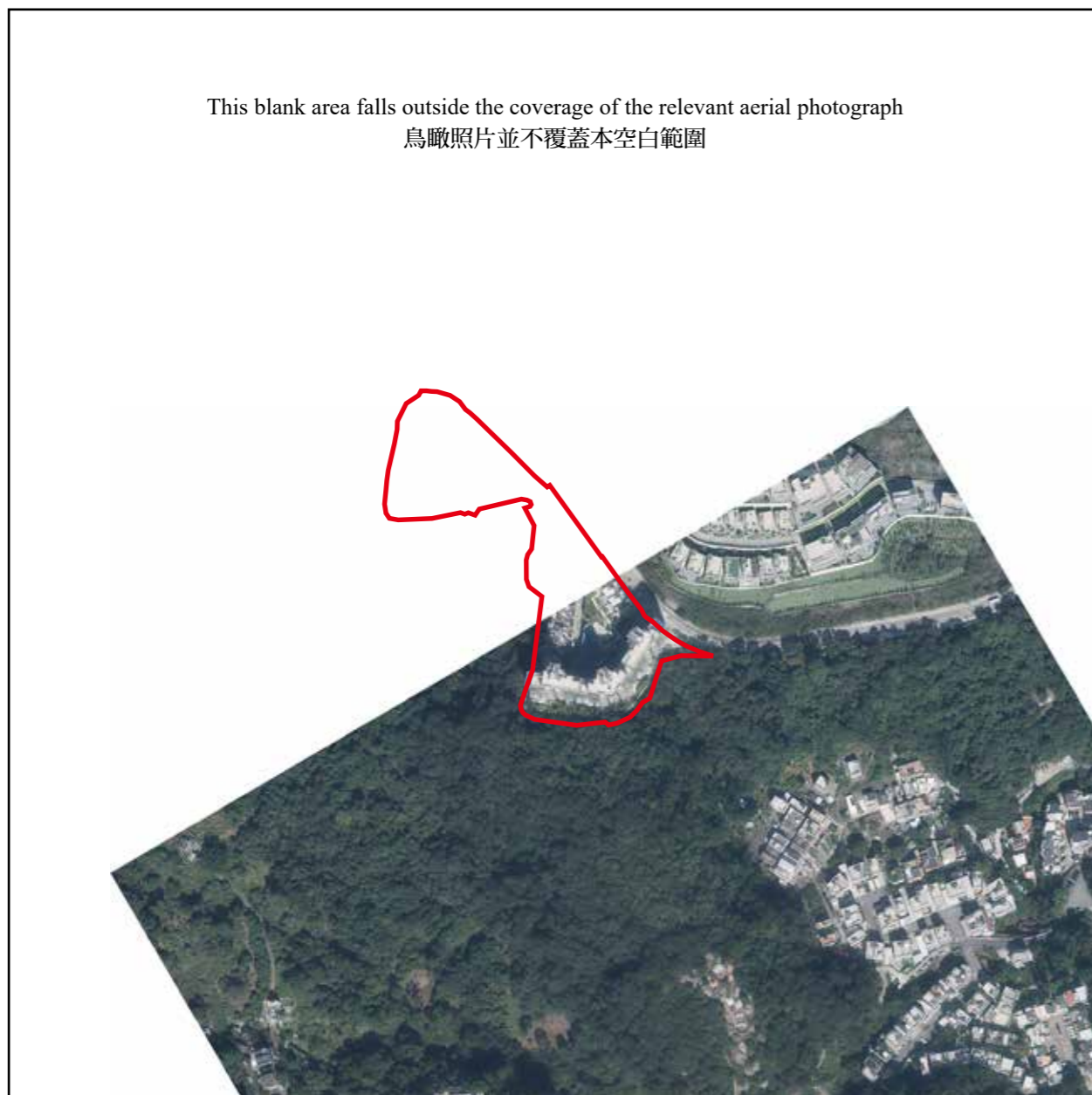

Adopted from part of the aerial photograph taken by the Survey and Mapping Office of the Lands Department at a flying height of 6,900 feet, Photo No. E173339C, dated 18 December 2022.

摘錄自地政總署測繪處在6,900呎的飛行高度拍攝之鳥瞰照片，照片編號E173339C，飛行日期：2022年12月18日。

#### Notes:

1. Copy of the aerial photograph of the Development is available for free inspection at the sales office during opening hours.
2. The aerial photograph may show more than the area required under the Residential Properties (First-hand Sales) Ordinance due to the technical reason that the boundary of the Development is irregular.

#### 備註：

1. 發展項目的鳥瞰照片之副本可於售樓處開放時間內免費查閱。
2. 由於發展項目的邊界不規則的技術原因，此鳥瞰照片所顯示的範圍可能超過《一手住宅物業銷售條例》所規定的範圍。

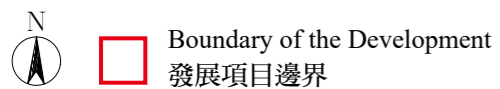

Survey and Mapping Office, Lands Department, The Government of HKSAR © Copyright reserved – reproduction by permission only.

香港特別行政區政府地政總署測繪處 © 版權所有，未經許可，不得翻印。



## AERIAL PHOTOGRAPH OF THE DEVELOPMENT

### 發展項目的鳥瞰照片

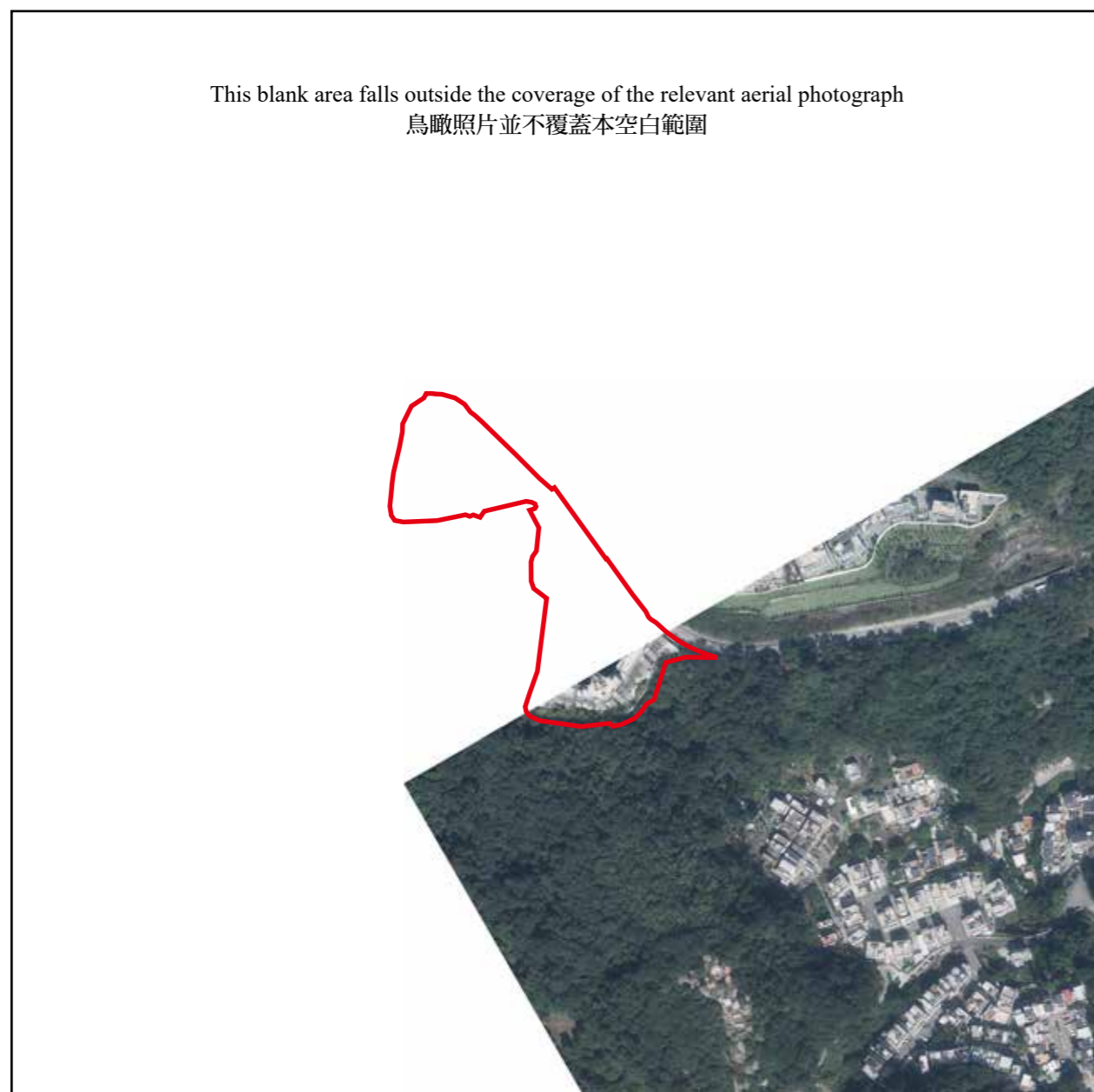

Adopted from part of the aerial photograph taken by the Survey and Mapping Office of the Lands Department at a flying height of 6,900 feet, Photo No. E173340C, dated 18 December 2022.

摘錄自地政總署測繪處在6,900呎的飛行高度拍攝之鳥瞰照片，照片編號E173340C，飛行日期：2022年12月18日。

#### Notes:

1. Copy of the aerial photograph of the Development is available for free inspection at the sales office during opening hours.
2. The aerial photograph may show more than the area required under the Residential Properties (First-hand Sales) Ordinance due to the technical reason that the boundary of the Development is irregular.

#### 備註：

1. 發展項目的鳥瞰照片之副本可於售樓處開放時間內免費查閱。
2. 由於發展項目的邊界不規則的技術原因，此鳥瞰照片所顯示的範圍可能超過《一手住宅物業銷售條例》所規定的範圍。

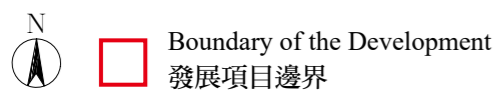

Survey and Mapping Office, Lands Department, The Government of HKSAR © Copyright reserved – reproduction by permission only.

香港特別行政區政府地政總署測繪處 © 版權所有，未經許可，不得翻印。



This page is deliberately left in blank.

此版乃特意留白。

# OUTLINE ZONING PLAN RELATING TO THE DEVELOPMENT 關於發展項目的分區計劃大綱圖

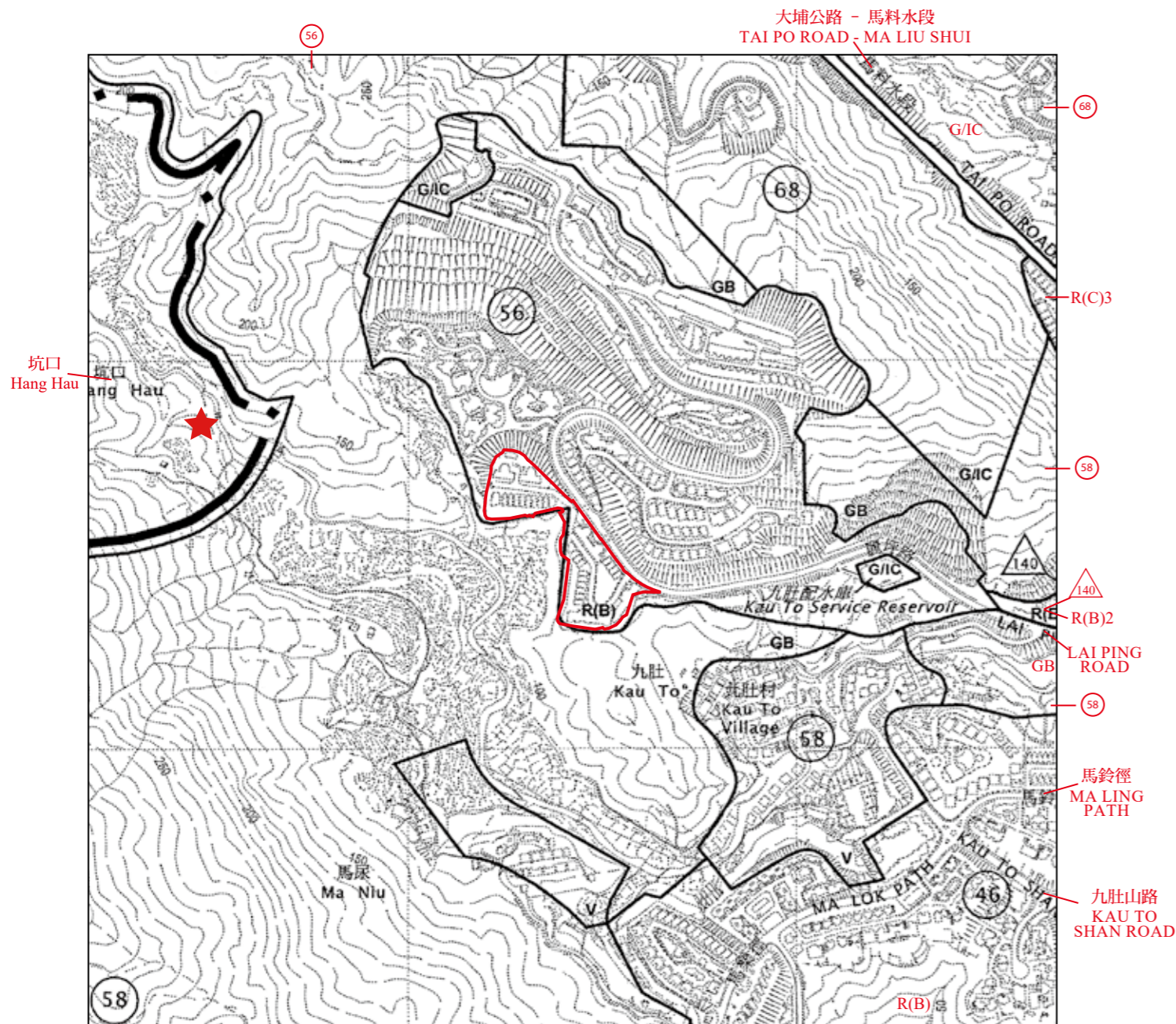

## Notation 圖例

### Zones 地帶

- R(B) Residential (Group B)  
住宅(乙類)
- R(C) Residential (Group C)  
住宅(丙類)
- V Village Type Development  
鄉村式發展
- G/IC Government, Institution or Community  
政府、機構或社區
- GB Green Belt  
綠化地帶

### Communications 交通

- Major Road and Junction  
主要道路及路口

### Miscellaneous 其他

- Boundary of Planning Scheme  
規劃範圍界線
- 1 Planning Area Number  
規劃區編號
- Maximum Building Height  
(In Metres Above Principal Datum)  
最高建築物高度  
(在主水平基準上若干米)
- This area is not covered under Outline Zoning Plan or Development Permission Area Plan, or the plan deemed to be a draft plan.  
此地帶並不被納入於分區計劃大綱圖或發展審批地區圖，或被當作草圖的圖則。

### Notes:

1. The last updated outline zoning plan and the attached schedule as at the date of printing of the sales brochure are available for free inspection at the sales office during opening hours.
2. The vendor advises prospective purchasers to conduct an on-site visit for a better understanding of the development site, its surrounding environment and the public facilities nearby.
3. The outline zoning plan may show more than the area required under the Residential Properties (First-hand Sales) Ordinance due to the technical reason that the boundary of the Development is irregular.
4. The plan, prepared by the Planning Department under the direction of the Town Planning Board, is reproduced with the permission of the Director of Lands. © The Government of Hong Kong SAR.

### 備註：

1. 在印刷售樓說明書當日所適用的最近期分區計劃大綱圖及其附表，可於售樓處開放時間內免費查閱。
2. 賣方建議準買方到有關發展地盤作實地考察，以對該發展地盤、其周邊地區環境及附近的公共設施有較佳了解。
3. 由於發展項目的邊界不規則的技術原因，此分區計劃大綱圖所顯示的範圍可能超過《一手住宅物業銷售條例》所規定的範圍。
4. 地圖為規劃署遵照城市規劃委員會指示擬備，版權屬香港特別行政區政府，經地政總署准許複印。

N  
Scale: 0M/米  
比例: 500M/米

Boundary of the Development  
發展項目邊界

Adopted from part of the draft Sha Tin Outline Zoning Plan, Plan No. S/ST/37, gazetted on 17 November 2023, with adjustments where necessary as shown in red.

摘錄自2023年11月17日刊憲之沙田分區計劃大綱草圖，圖則編號為S/ST/37，有需要處經修正處理，以紅色表示。

This page is deliberately left in blank.  
此版乃特意留白。



# LAYOUT PLAN OF THE DEVELOPMENT

## 發展項目的布局圖

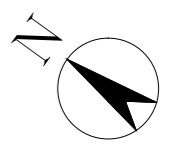
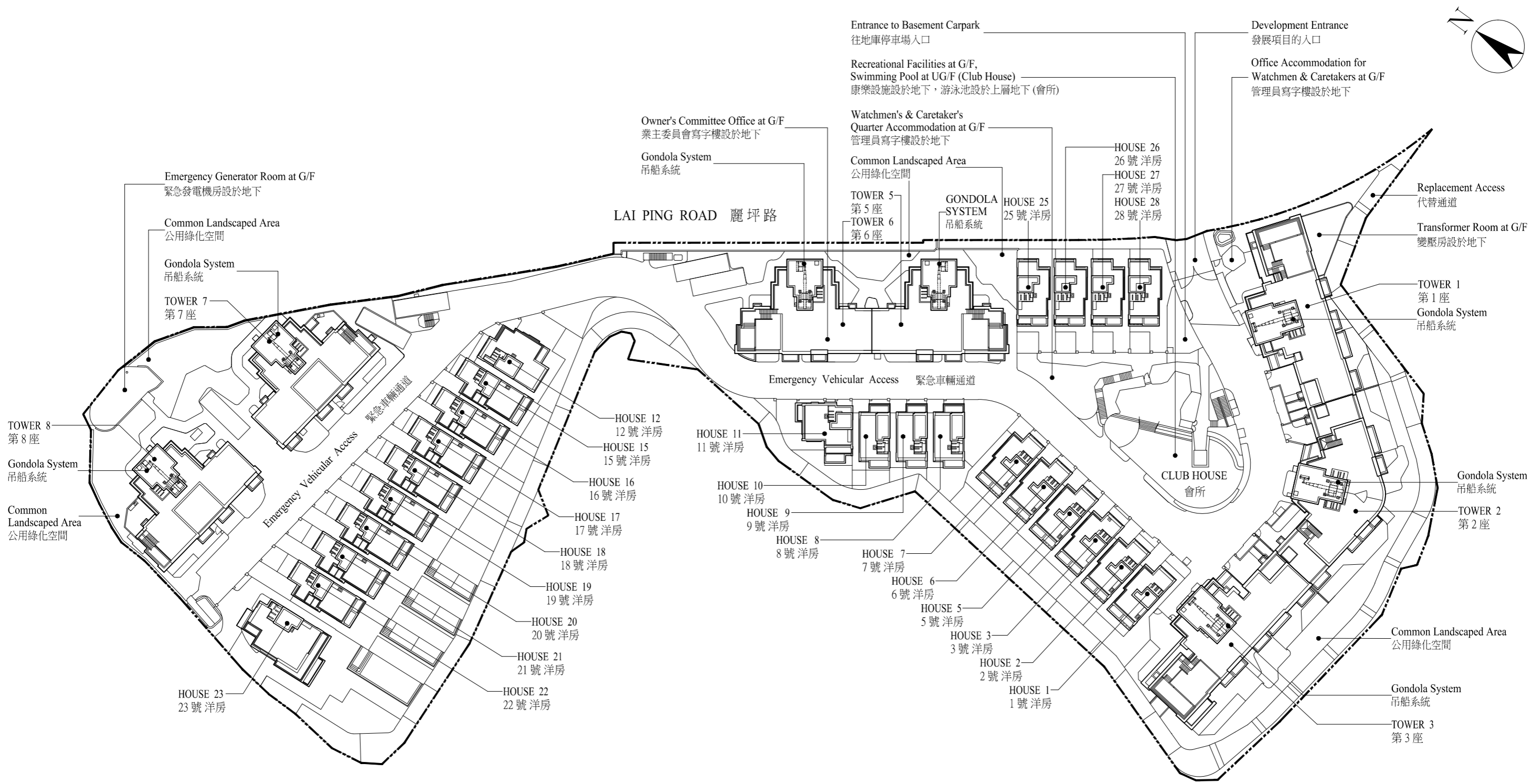

----- Boundary of the Development  
發展項目的界線

Scale: 0M/米 30M/米  
比例: 0 30

## FLOOR PLANS OF RESIDENTIAL PROPERTIES IN THE DEVELOPMENT

### 發展項目的住宅物業的樓面平面圖

#### Legend 圖例

A.C.	= ALUMINIUM CLADDING = 鋁質飾板
A/C PLANT	= AIR CONDITION PLANT = 冷氣機櫃
A/C PLATFORM	= AIR CONDITION PLATFORM = 冷氣機平台
A/C PLATFORM ABOVE	= AIR CONDITION PLATFORM ABOVE = 上層冷氣機平台
A.F. ABOVE	= ARCHITECTURAL FEATURE ABOVE = 上層建築裝飾
ALUM. A.F.	= ALUMINIUM ARCHITECTURAL FEATURE = 鋁質建築裝飾
ALUMINIUM PANEL ROOF	= 鋁質板天台
A.F.	= ARCHITECTURAL FEATURE = 建築裝飾
BAL.	= BALCONY = 露台
BAL. ABOVE	= BALCONY ABOVE = 上層露台
BEDROOM	= 睡房
BATH	= BATHROOM = 浴室
BUILDING LINE ABOVE	= 建築線置上
CANOPY	= 簷篷
CANOPY ABOVE	= 上層簷篷
CANOPY WITH A.C.	= CANOPY WITH ALUMINIUM CLADDING = 鋁質飾板簷篷
CAR PARK	= CARPARK = 停車場
CABLE DUCT	= 電線管道槽
CARETAKER'S COUNTER	= 管理員櫃台
COMMON LANDSCAPED AREA	= 公用綠化空間
COVERED LANDSCAPED AREA	= 有蓋公共綠化空間
DN	= DOWN = 下
DOG HOUSE	= 管道房
DINING	= DINING ROOM = 飯廳
E.L.V. / TEL. DUCT	= EXTRA LOW VOLTAGE ELECTRICAL & TELEPHONE DUCT = 特低電壓及電話機房
E.M.C.	= ELECTRICAL METER CABINET = 電錶箱
ENSUITE	= 套房
ENTRANCE LOBBY	= 入口大堂
ELV. DUCT	= EXTRA LOW VOLTAGE ELECTRICAL DUCT = 低電壓槽
FOYER	= 玄關
F.S. CONTROL & SPRINKLER CONTROL VALVE ROOM	= FIRE SERVICE CONTROL AND SPRINKLER CONTROL VALVE ROOM = 消防控制室及消防花灑控制室
F.S. INLET	= FIRE SERVICE INLET = 消防入水掣
FLAT	= 單位
FLAT ROOF	= 平台
F.S. CHECK METER CABINET	= FIRE SERVICE CHECK METER CABINET = 消防水錶櫃
F.S. PUMP ROOM	= FIRE SERVICE PUMP ROOM = 消防設備泵房
F.S. WATER TANK	= FIRE SERVICE WATER TANK = 消防水箱
F.S. REPEATER PANEL	= FIRE SERVICE REPEATER PANEL = 消防訊號顯示板
GARDEN	= FRONT GARDEN = 花園
GARDEN DUPLEX	= 花園複式單位
GONDOLA SYSTEM	= 吊船系統
GAS WATER HEATER CABINET	= 煤氣熱水爐箱
HOUSE	= 洋房
H.R.	= HOSE REEL = 消防喉轆
INACCESSIBLE FLAT ROOF	= 不可到達的平台
KIT	= KITCHEN = 廚房

• “Terrace Apartment”, “Garden Apartment” and “Courtyard Penthouse” are names for marketing purposes only and will not appear in any Deed of Mutual Covenant, the Preliminary Agreement for Sale and Purchase, Agreement for Sale and Purchase, Assignment, or any other title deeds and documents relating to the Development. The names as appearing on the approved building plans are: Flat A on 1/F of Tower 1 for Terrace Apartment on 1/F of Tower 1; Flat B on G/F of Tower 2 for Garden Apartment on G/F of Tower 2; Flat B on G/F of Tower 3 for Garden Apartment on G/F of Tower 3; Flat A on G/F of Tower 7 for Garden Apartment on G/F of Tower 7; Penthouse on 11/F of Tower 7 for Courtyard Penthouse on 11/F of Tower 7; Flat B on G/F of Tower 8 for Garden Apartment on G/F of Tower 8; Penthouse on 11/F of Tower 8 for Courtyard Penthouse on 11/F of Tower 8.

LAV.	= LAVATORY = 洗手間
LETTER BOX AND DOOR PHONE SYSTEM	= 信箱及對講機系統
LIFT	= 升降機
LIFT LOBBY	= 升降機大堂
LIFT SHAFT	= 升降機槽
LIFT MACH. RM.	= LIFT MACHINE ROOM = 升降機機房
LINE OF U.P. ABOVE	= LINE OF UTILITY PLATFORM ABOVE = 工作平台置上線
LIVING	= LIVING ROOM = 客廳
LETTER BOX	= 信箱
LIFT PLATFORM	= 升降機平台
LOADING / UNLOADING	= LOADING AND UNLOADING PARKING SPACE = 上落貨停車位
M.C.B.	= MINIATURE CIRCUIT BREAKER BOARD = 微型斷路箱
M. BATH	= MASTER BATHROOM = 主人浴室
M. BEDROOM	= MASTER BEDROOM = 主人睡房
M.L.	= METAL LOUVRE = 金屬百頁
M.V.	= MECHANICAL VENTILATION = 機械通風
OUTDOOR VRV AREA	= OUTDOOR VARIABLE REFRIGERANT VOLUME AREA = 室外變頻中央空調系統空間
P.D.	= PIPE DUCT = 喉管管線槽
PLANTER	= 花槽
POWDER ROOM	= 客廳/飯廳洗手間
POOL FILTRATION PIT	= 泳池過濾機井
PRIVATE SWIMMING POOL	= 私人游泳池
PROPRIETARY JACUZZI	= 專有的按摩浴池
ROOF	= 天台
ROOF FOR SKY POOL PENTHOUSE	= 天台供SKY POOL PENTHOUSE
ROOF FOR SPA DUPLEX	= 天台供SPA DUPLEX
ROOF FOR COURTYARD PENTHOUSE	= 天台供・COURTYARD PENTHOUSE
R.S.M.R.R.	= REFUSE STORAGE AND MATERIAL RECOVERY ROOM = 垃圾及物料回收室
ST. RM	= STORE ROOM = 儲物室
SKYLIGHT	= 天窗
SKYLIGHT ABOVE	= 天窗置上
STUDY	= STUDY ROOM = 書房
SWIMMING POOL	= 游泳池
TEL.	= TELEPHONE CABINET = 電話線箱
T.D.	= TEL. DUCT = TELEPHONE DUCT = 電話線槽
T.G.	= TOWN GAS PIPE DUCT = 煤氣管道槽
U	= UP = 上
U.P.	= UTILITY PLATFORM = 工作平台
U.P. ABOVE	= UTILITY PLATFORM ABOVE = 上層工作平台
UPPER ROOF	= 上層天台
UTILITY	= UTILITY ROOM = 工作間
VOID	= 中空
VOID ABOVE	= 中空置上
VOID OVER	= 上層中空
V.D.	= VENT DUCT = 排氣管道
VRV ROOM	= VARIABLE REFRIGERANT VOLUME ROOM = 變頻中央空調系統房
WALL OF ADJOINING TOWER	= 圍邊大樓牆身
W.M.C.	= WATER METER CABINET = 水錶箱

• 「Terrace Apartment」、 「Garden Apartment」及「Courtyard Penthouse」僅為市場推廣之用的名稱，並不會於關於發展項目的任何公契、臨時買賣合約、買賣合約、轉讓契及契據出現。經批准的建築圖則上顯示的名稱為：第1座1樓A單位（即第1座1樓Terrace Apartment）；第2座地下B單位（即第2座地下Garden Apartment）；第3座地下B單位（即第3座地下Garden Apartment）；第7座地下A單位（即第7座地下Garden Apartment）；第7座11樓Penthouse（即第7座11樓Courtyard Penthouse）；第8座地下B單位（即第8座地下Garden Apartment）；第8座11樓Penthouse（即第8座11樓Courtyard Penthouse）。

# FLOOR PLANS OF RESIDENTIAL PROPERTIES IN THE DEVELOPMENT

## 發展項目的住宅物業的樓面平面圖

### House 1 1號洋房

Floor 樓層	The thickness of the floor slabs (excluding plaster) of each House (mm) 每座洋房的樓板(不包括灰泥)的厚度(毫米)	The floor-to-floor height of each House (mm) 每座洋房的層與層之間的高度(毫米)
Basement 地庫	170, 200	4150, 4550, 4850*
G/F 地下	125, 150, 200	3900, 4200, 4600*
1/F 1樓	125, 150, 200	3500, 3600
2/F 2樓	150	3500, 3550, 3900
Roof 天台	150	2350, 2750

The internal areas of the residential properties on the upper floors will generally be slightly larger than those on the lower floors because of the reducing thickness of the structural walls on the upper floors.

因住宅物業的較高樓層的結構牆的厚度遞減，較高樓層的內部面積，一般比較低樓層的內部面積稍大。

#### Notes:

- The dimensions of floor plans are all structural dimensions in millimeter.
- There may be architectural features and/or exposed pipes on external walls of the residential properties. For details, please refer to the latest approved building plans.
- Common pipes exposed and/or enclosed in cladding are located at/adjacent to flat roof and/or external wall of the residential properties. For details, please refer to the latest approved building plans.
- There are ceiling bulkheads and/or sunken slab at living/dining room, bedrooms, ensuites, study rooms, utility rooms, store rooms, corridors, bathrooms, powder rooms, lavatories and kitchen of some residential units for the air-conditioning system and/or mechanical and electrical services.
- Symbols of fittings and fitments shown in the floor plans, such as bathtubs, sink, water closets, shower, sink counter etc are architectural symbols extracted from the latest approved general building plans for general indication only.
- [\*] Inclusive of the thickness of mass concrete fill on sunken slab.

#### 備註：

- 平面圖所列之尺寸數字為以毫米標示之建築尺寸。
- 住宅物業的外牆設有建築裝飾及/或外露喉管。詳細資料請參考最新批准之建築圖則。
- 住宅物業的平台及/或外牆設有外露及/或外牆裝飾板內藏之公用喉管。詳細資料請參考最新批准的建築圖則。
- 部份住宅單位的客/飯廳、睡房、套房、書房、工作間、儲物室、走廊、浴室、客廳洗手間、洗手間及廚房有假天花及/或有跌級樓板用以裝置冷氣系統及/或機電設備。
- 樓面平面圖上所顯示的形象裝置符號，例如浴缸、洗滌盆、坐廁、花灑、洗滌盆櫃乃摘自最新的經批准的建築圖則，並只作一般性標誌。
- [\*] 包括跌級樓板上之混凝土填充層厚度。

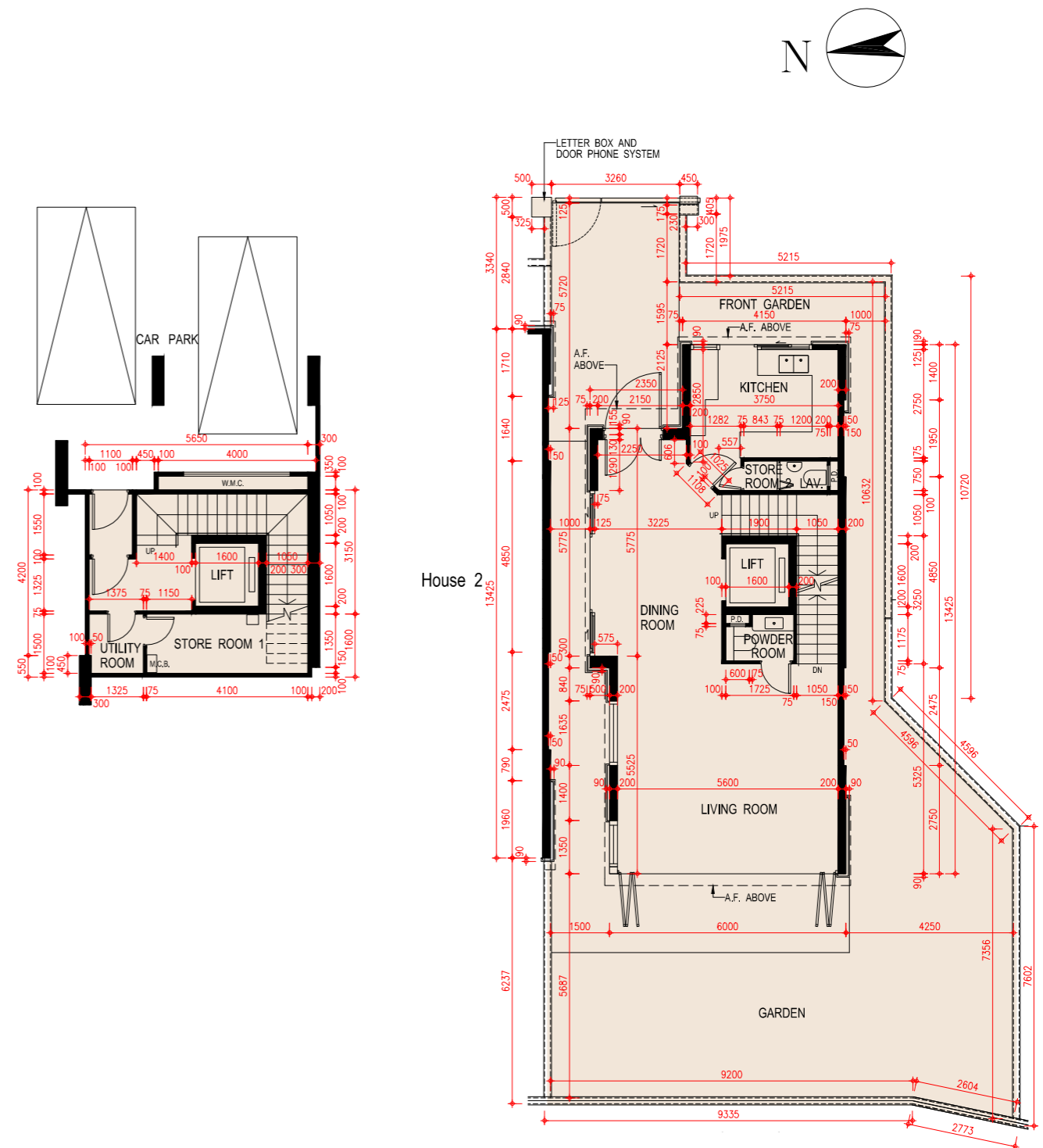

**Basement Plan**  
地庫平面圖

**G/F Plan**  
地下平面圖

Scale: 0M/米 5M/米  
比例: 1:500

**FLOOR PLANS OF RESIDENTIAL PROPERTIES IN THE DEVELOPMENT**  
**發展項目的住宅物業的樓面平面圖**

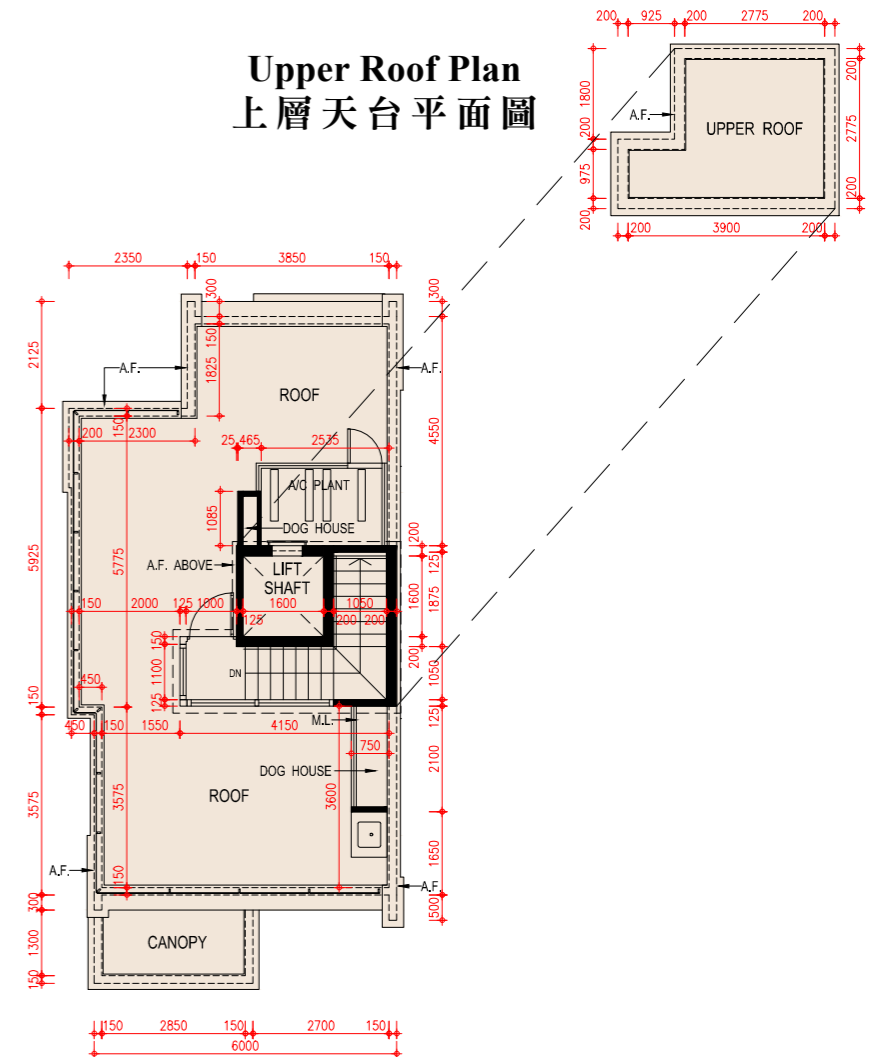
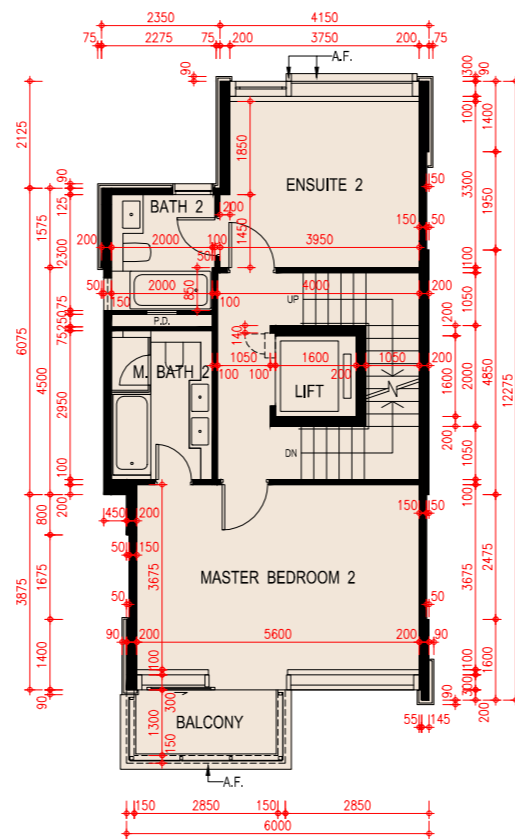
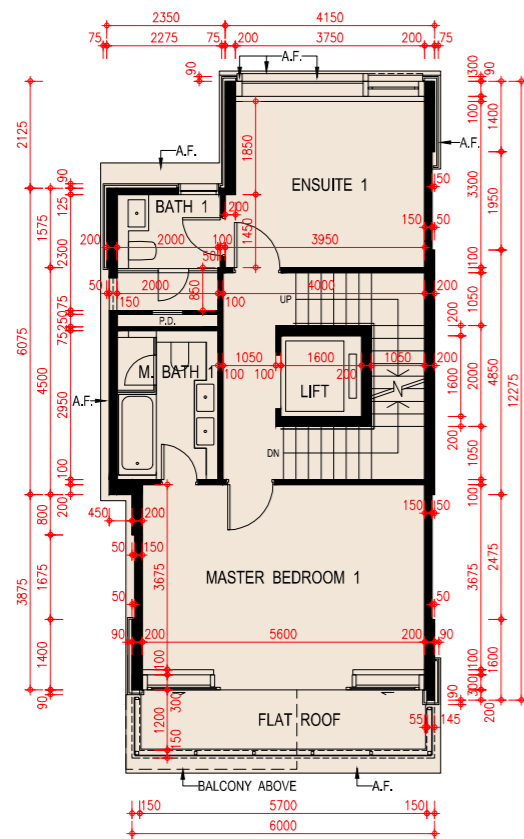

1/F Plan  
一樓平面圖

2/F Plan  
二樓平面圖

Roof Plan  
天台平面圖

Scale: 0M/米 5M/米  
 比例: 5M/米



# FLOOR PLANS OF RESIDENTIAL PROPERTIES IN THE DEVELOPMENT

## 發展項目的住宅物業的樓面平面圖

### House 2 2號洋房

Floor 樓層	The thickness of the floor slabs (excluding plaster) of each House (mm) 每座洋房的樓板(不包括灰泥)的厚度(毫米)	The floor-to-floor height of each House (mm) 每座洋房的層與層之間的高度(毫米)
Basement 地庫	170, 200	4150, 4550, 4850*
G/F 地下	125, 150, 200	3900, 4200, 4600*
1/F 1樓	125, 150, 200	3500, 3600
2/F 2樓	150	3500, 3550, 3900
Roof 天台	150	2350, 2750

The internal areas of the residential properties on the upper floors will generally be slightly larger than those on the lower floors because of the reducing thickness of the structural walls on the upper floors.

因住宅物業的較高樓層的結構牆的厚度遞減，較高樓層的內部面積，一般比較低樓層的內部面積稍大。

**Notes:**

- The dimensions of floor plans are all structural dimensions in millimeter.
- There may be architectural features and/or exposed pipes on external walls of the residential properties. For details, please refer to the latest approved building plans.
- Common pipes exposed and/or enclosed in cladding are located at/adjacent to flat roof and/or external wall of the residential properties. For details, please refer to the latest approved building plans.
- There are ceiling bulkheads and/or sunken slab at living/dining room, bedrooms, ensuites, study rooms, utility rooms, store rooms, corridors, bathrooms, powder rooms, lavatories and kitchen of some residential units for the air-conditioning system and/or mechanical and electrical services.
- Symbols of fittings and fitments shown in the floor plans, such as bathtubs, sink, water closets, shower, sink counter etc are architectural symbols extracted from the latest approved general building plans for general indication only.
- [\*] Inclusive of the thickness of mass concrete fill on sunken slab.

**備註：**

- 平面圖所列之尺寸數字為以毫米標示之建築尺寸。
- 住宅物業的外牆設有建築裝飾及/或外露喉管。詳細資料請參考最新批准之建築圖則。
- 住宅物業的平台及/或外牆設有外露及/或外牆裝飾板內藏之公用喉管。詳細資料請參考最新批准的建築圖則。
- 部份住宅單位的客/飯廳、睡房、套房、書房、工作間、儲物室、走廊、浴室、客廳洗手間、洗手間及廚房有假天花及/或有跌級樓板用以裝置冷氣系統及/或機電設備。
- 樓面平面圖上所顯示的形象裝置符號，例如浴缸、洗滌盆、坐廁、花灑、洗滌盆櫃乃摘自最新的經批准的建築圖則，並只作一般性標誌。
- [\*] 包括跌級樓板上之混凝土填充層厚度。

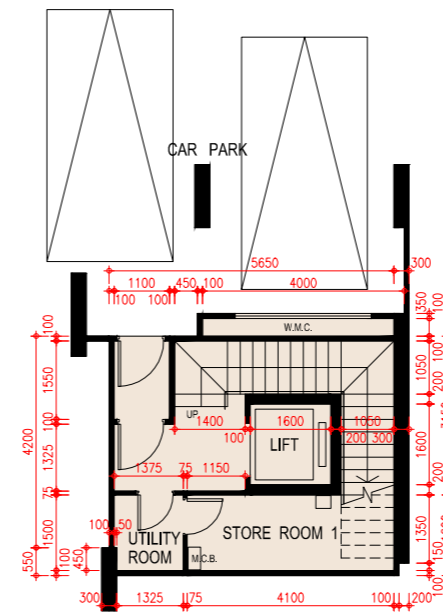

**Basement Plan**  
地庫平面圖

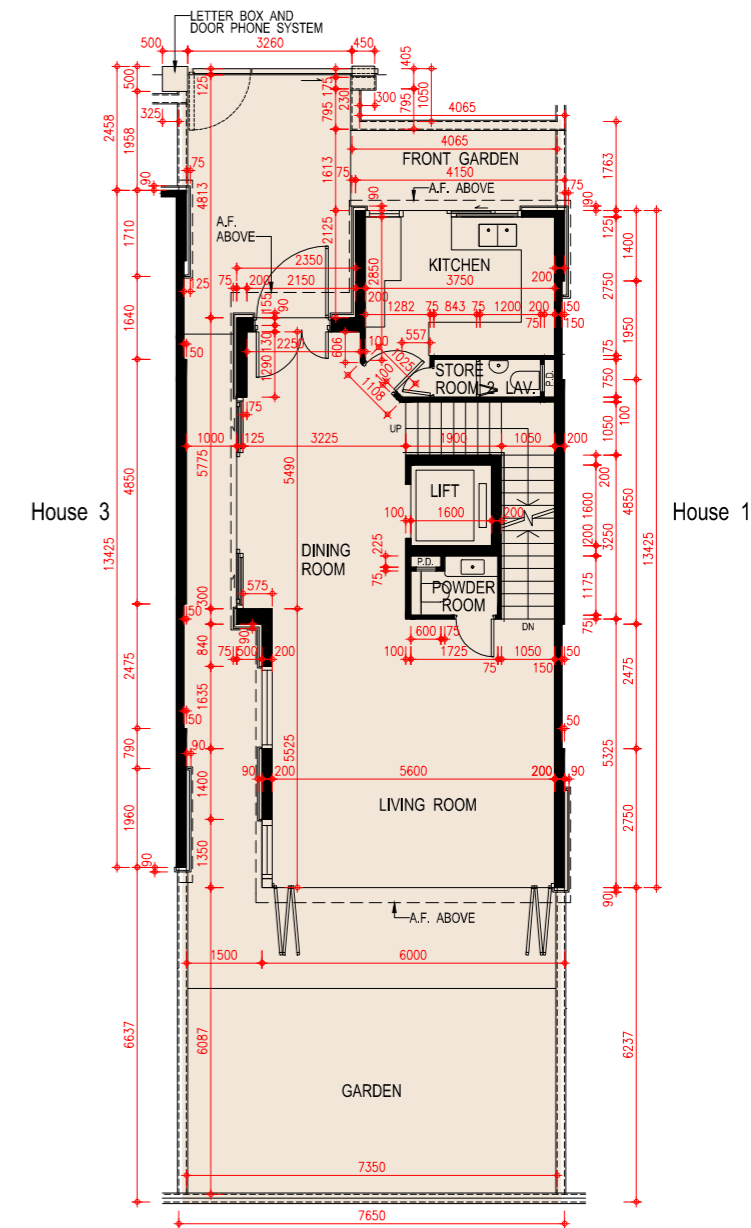

**G/F Plan**  
地下平面圖

Scale: 0M/米 5M/米  
比例:



FLOOR PLANS OF RESIDENTIAL PROPERTIES IN THE DEVELOPMENT

發展項目的住宅物業的樓面平面圖

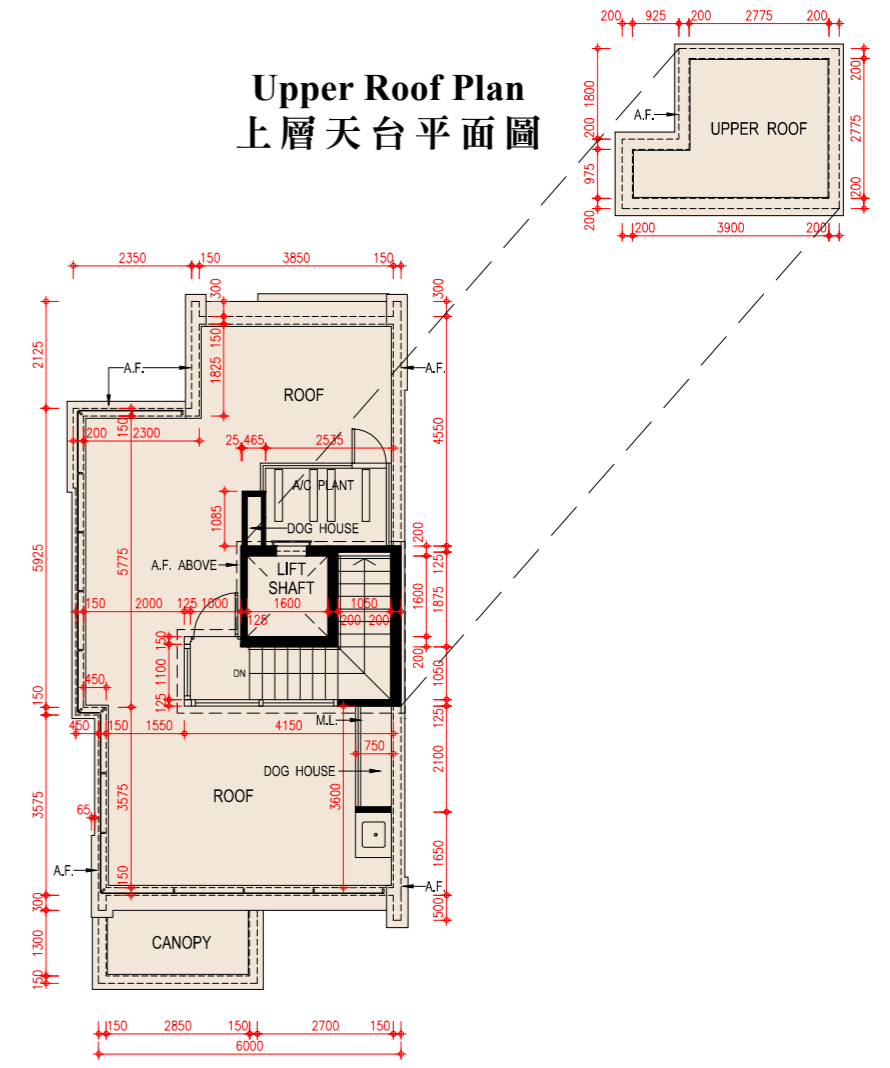
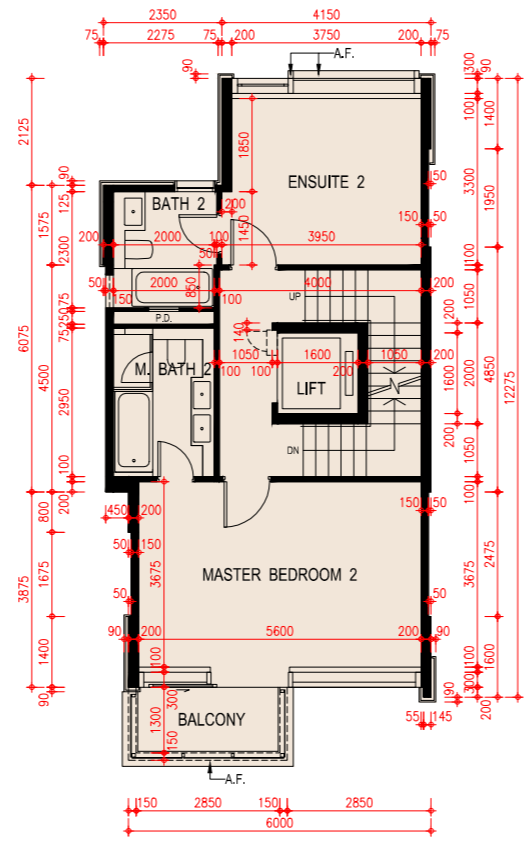
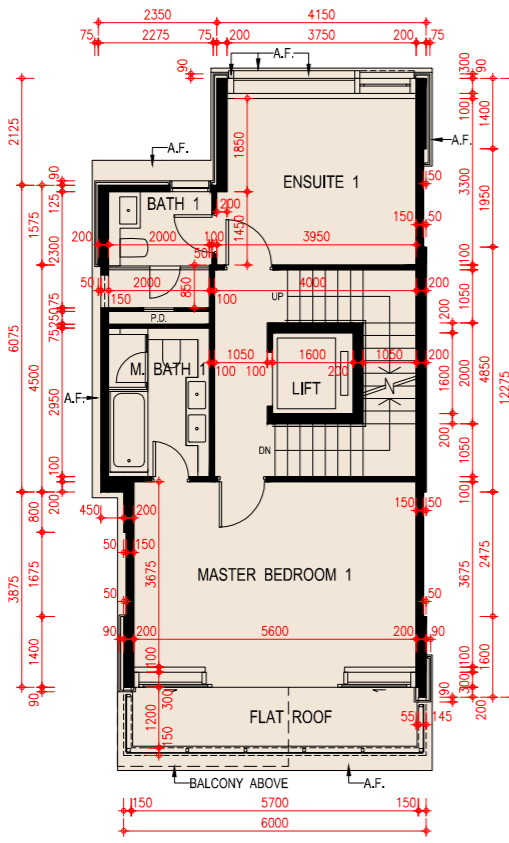

Scale: 0M/米 5M/米  
比例: 1:500

# FLOOR PLANS OF RESIDENTIAL PROPERTIES IN THE DEVELOPMENT

## 發展項目的住宅物業的樓面平面圖

### House 3 3號洋房

Floor 樓層	The thickness of the floor slabs (excluding plaster) of each House (mm) 每座洋房的樓板(不包括灰泥)的厚度(毫米)	The floor-to-floor height of each House (mm) 每座洋房的層與層之間的高度(毫米)
Basement 地庫	170, 200	4150, 4550, 4850*
G/F 地下	125, 150, 200	3900, 4200, 4600*
1/F 1樓	125, 150, 200	3500, 3600
2/F 2樓	150	3500, 3550, 3900
Roof 天台	180	2350, 2750

The internal areas of the residential properties on the upper floors will generally be slightly larger than those on the lower floors because of the reducing thickness of the structural walls on the upper floors.

因住宅物業的較高樓層的結構牆的厚度遞減，較高樓層的內部面積，一般比較低樓層的內部面積稍大。

#### Notes:

- The dimensions of floor plans are all structural dimensions in millimeter.
- There may be architectural features and/or exposed pipes on external walls of the residential properties. For details, please refer to the latest approved building plans.
- Common pipes exposed and/or enclosed in cladding are located at/adjacent to flat roof and/or external wall of the residential properties. For details, please refer to the latest approved building plans.
- There are ceiling bulkheads and/or sunken slab at living/dining room, bedrooms, ensuites, study rooms, utility rooms, store rooms, corridors, bathrooms, powder rooms, lavatories and kitchen of some residential units for the air-conditioning system and/or mechanical and electrical services.
- Symbols of fittings and fitments shown in the floor plans, such as bathtubs, sink, water closets, shower, sink counter etc are architectural symbols extracted from the latest approved general building plans for general indication only.
- [\*] Inclusive of the thickness of mass concrete fill on sunken slab.
- House 3 has been altered by way of minor works or exempted works under the Buildings Ordinance after the completion of the Development. The latest condition of which is shown on the relevant floor plans. The alterations are as follows:
  - Adjustments have been made to the main entrance at G/F.
  - Adjustments have been made to the door of Lavatory at G/F.
  - Adjustments have been made to the door of Master Bathroom at 1/F.
  - Glass partitions have been added to Master Bathroom 1 at 1/F.
  - Adjustments have been made to the glass door of Bathroom 1 at 1/F.

#### 備註：

- 平面圖所列之尺寸數字為以毫米標示之建築尺寸。
- 住宅物業的外牆設有建築裝飾及/或外露喉管。詳細資料請參考最新批准之建築圖則。
- 住宅物業的平台及/或外牆設有外露及/或外牆裝飾板內藏之公用喉管。詳細資料請參考最新批准的建築圖則。
- 部份住宅單位的客/飯廳、睡房、套房、書房、工作間、儲物室、走廊、浴室、客廳洗手間、洗手間及廚房有假天花及/或有跌級樓板用以裝置冷氣系統及/或機電設備。
- 樓面平面圖上所顯示的形象裝置符號，例如浴缸、洗滌盆、坐廁、花灑、洗滌盆櫃乃摘自最新的經批准的建築圖則，並只作一般性標誌。
- [\*] 包括跌級樓板上之混凝土填充層厚度。
- 3號洋房在發展項目落成後進行小型工程或獲《建築物條例》豁免的工程而有所改動。現狀請參考有關平面圖，該等改動如下：
  - 地下單位入口門已被改動。
  - 地下洗手間的門已被改動。
  - 1樓主人浴室1的門已被改動。
  - 1樓主人浴室1已加建玻璃間隔。
  - 1樓浴室1的玻璃間隔已被改動。

### As-is Part Plan of G/F (See Notes 7A & 7B) 地下之部份現狀圖 (見備註7A及7B)

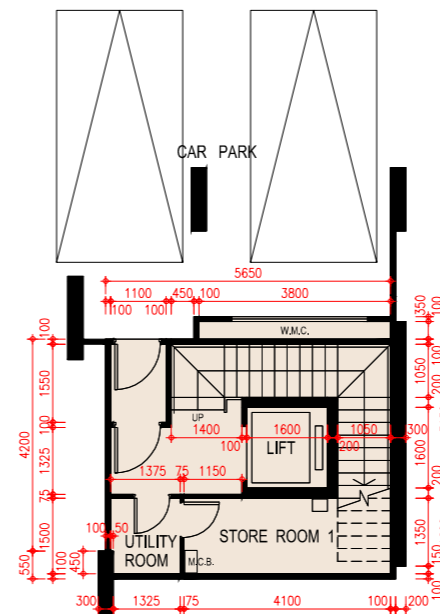
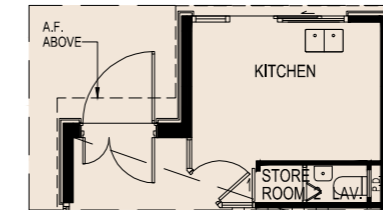

Basement Plan  
地庫平面圖

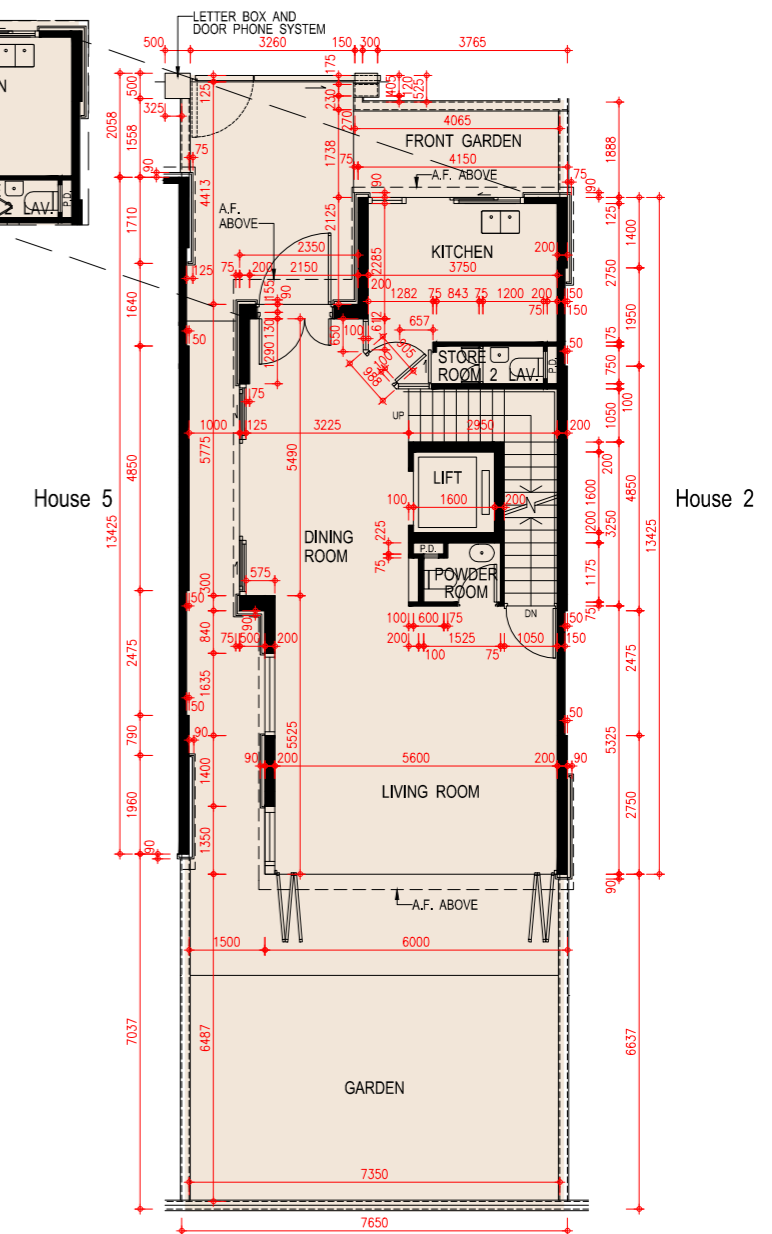

G/F Plan  
地下平面圖

Scale: 0M/米  
比例: 1:500

FLOOR PLANS OF RESIDENTIAL PROPERTIES IN THE DEVELOPMENT

發展項目的住宅物業的樓面平面圖

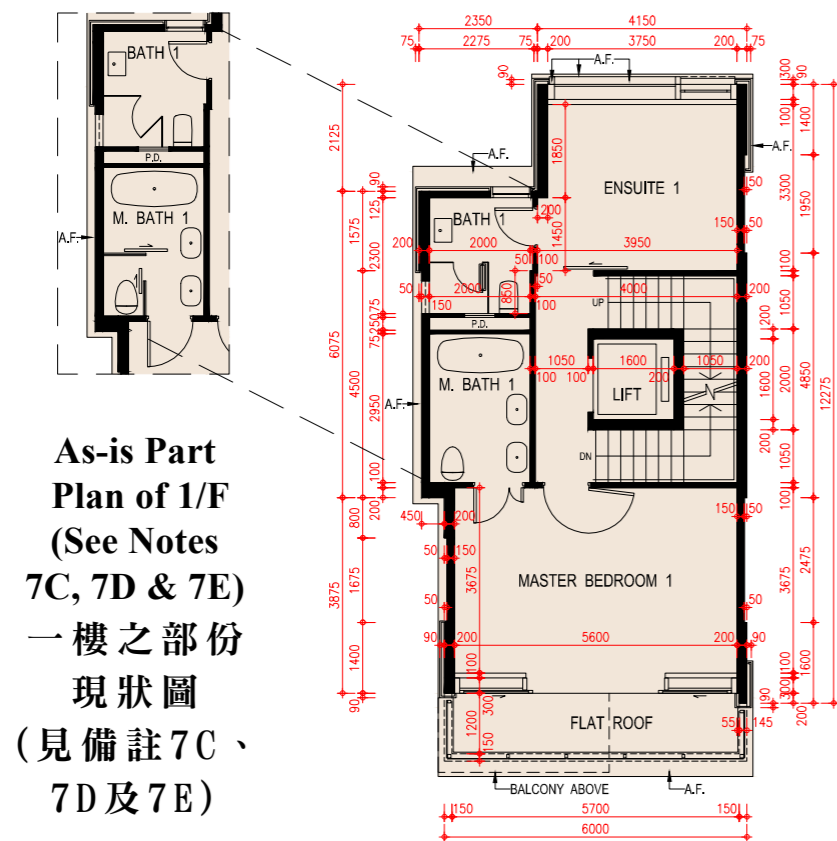

1/F Plan  
一樓平面圖

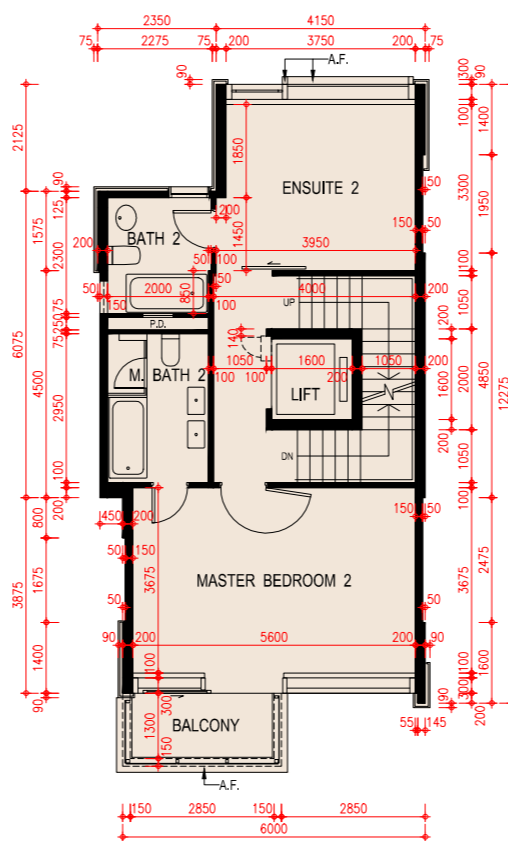

2/F Plan  
二樓平面圖

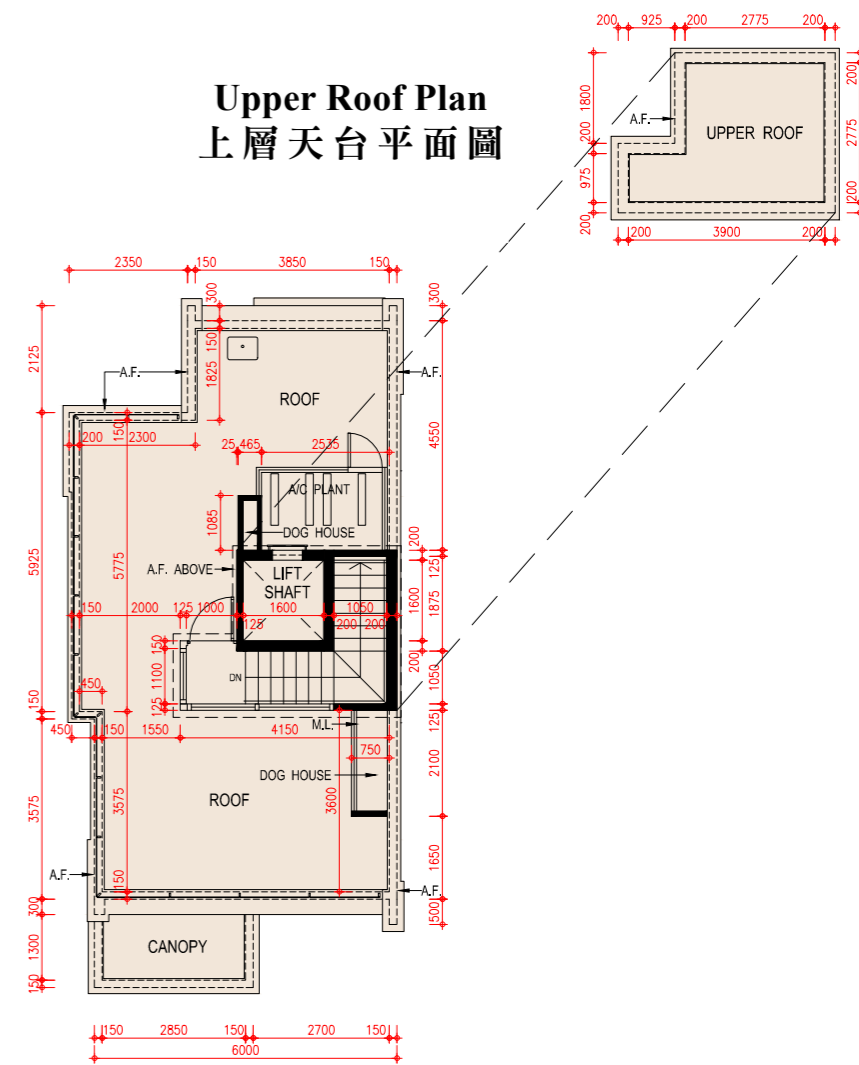

Roof Plan  
天台平面圖

Scale: 0M/米 5M/米  
比例:

# FLOOR PLANS OF RESIDENTIAL PROPERTIES IN THE DEVELOPMENT

## 發展項目的住宅物業的樓面平面圖

### House 5 5號洋房

Floor 樓層	The thickness of the floor slabs (excluding plaster) of each House (mm) 每座洋房的樓板(不包括灰泥)的厚度(毫米)	The floor-to-floor height of each House (mm) 每座洋房的層與層之間的高度(毫米)
Basement 地庫	170, 200	4150, 4550, 4850*
G/F 地下	125, 150, 200	3900, 4200, 4600*
1/F 1樓	125, 150, 200	3500, 3600
2/F 2樓	150	3500, 3550, 3900
Roof 天台	150	2350, 2750

The internal areas of the residential properties on the upper floors will generally be slightly larger than those on the lower floors because of the reducing thickness of the structural walls on the upper floors.

因住宅物業的較高樓層的結構牆的厚度遞減，較高樓層的內部面積，一般比較低樓層的內部面積稍大。

#### Notes:

- The dimensions of floor plans are all structural dimensions in millimeter.
- There may be architectural features and/or exposed pipes on external walls of the residential properties. For details, please refer to the latest approved building plans.
- Common pipes exposed and/or enclosed in cladding are located at/adjacent to flat roof and/or external wall of the residential properties. For details, please refer to the latest approved building plans.
- There are ceiling bulkheads and/or sunken slab at living/dining room, bedrooms, ensuites, study rooms, utility rooms, store rooms, corridors, bathrooms, powder rooms, lavatories and kitchen of some residential units for the air-conditioning system and/or mechanical and electrical services.
- Symbols of fittings and fitments shown in the floor plans, such as bathtubs, sink, water closets, shower, sink counter etc are architectural symbols extracted from the latest approved general building plans for general indication only.
- [\*] Inclusive of the thickness of mass concrete fill on sunken slab.

#### 備註：

- 平面圖所列之尺寸數字為以毫米標示之建築尺寸。
- 住宅物業的外牆設有建築裝飾及/或外露喉管。詳細資料請參考最新批准之建築圖則。
- 住宅物業的平台及/或外牆設有外露及/或外牆裝飾板內藏之公用喉管。詳細資料請參考最新批准的建築圖則。
- 部份住宅單位的客/飯廳、睡房、套房、書房、工作間、儲物室、走廊、浴室、客廳洗手間、洗手間及廚房有假天花及/或有跌級樓板用以裝置冷氣系統及/或機電設備。
- 樓面平面圖上所顯示的形象裝置符號，例如浴缸、洗滌盆、坐廁、花灑、洗滌盆櫃乃摘自最新的經批准的建築圖則，並只作一般性標誌。
- [\*] 包括跌級樓板上之混凝土填充層厚度。

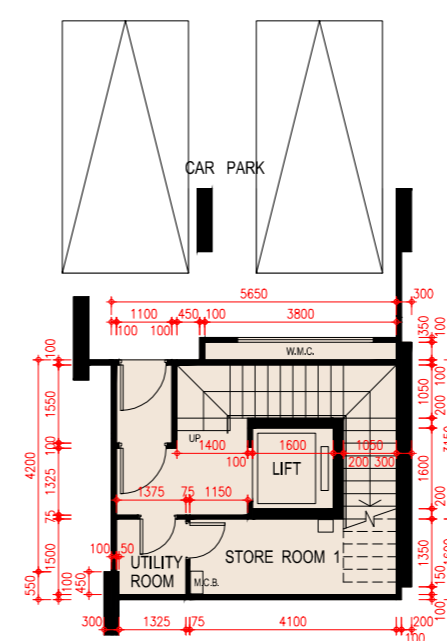

**Basement Plan**  
地庫平面圖

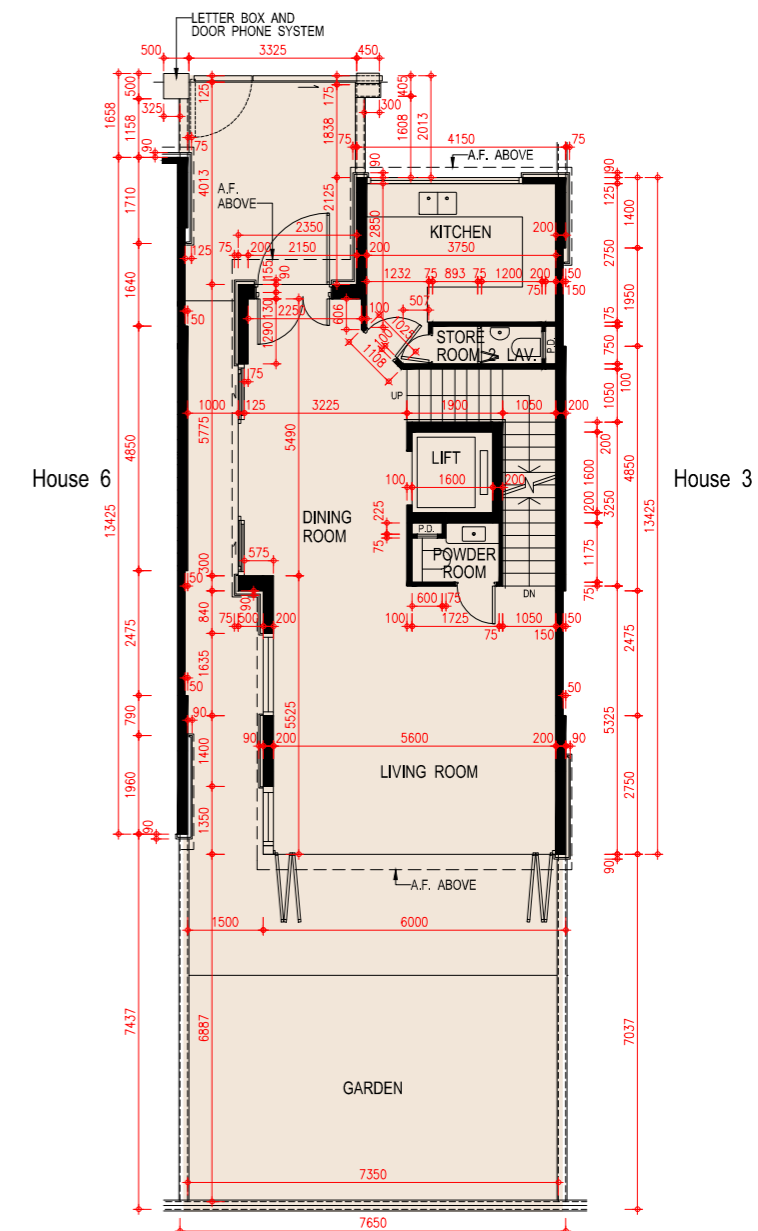

**G/F Plan**  
地下平面圖

Scale: 0M/米  
比例: 5M/米



**FLOOR PLANS OF RESIDENTIAL PROPERTIES IN THE DEVELOPMENT**  
**發展項目的住宅物業的樓面平面圖**

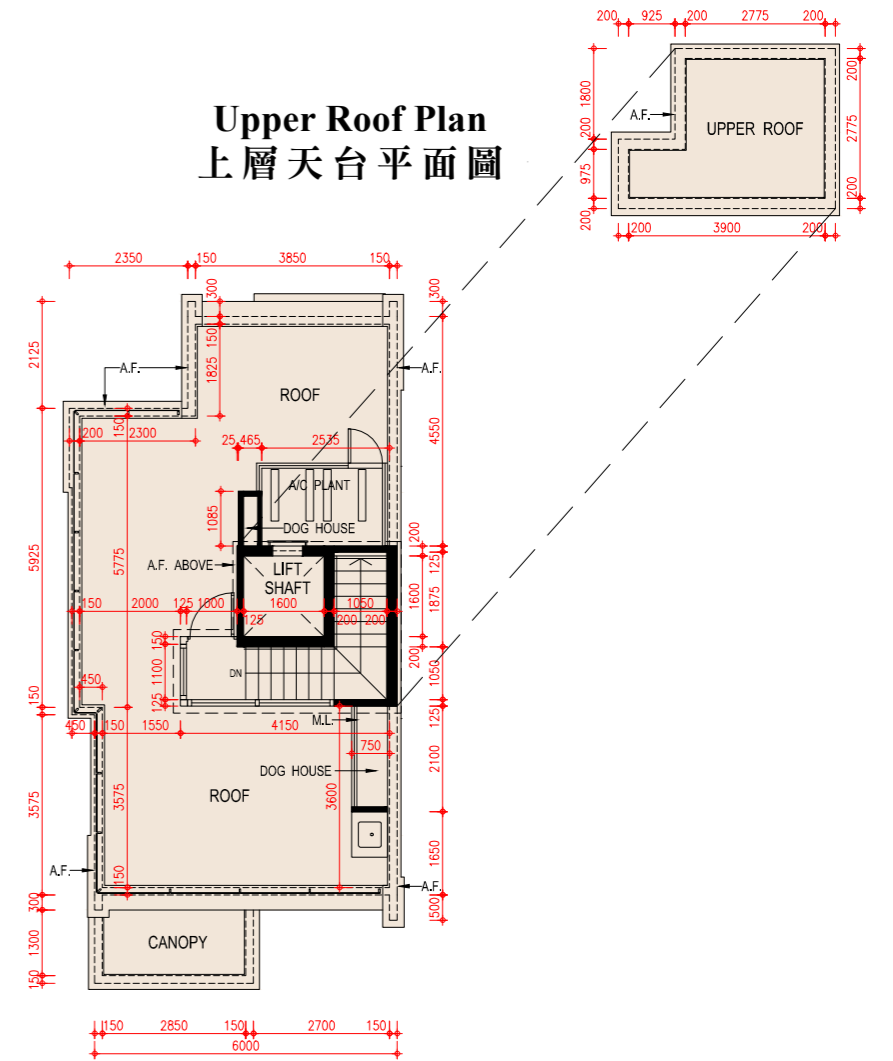
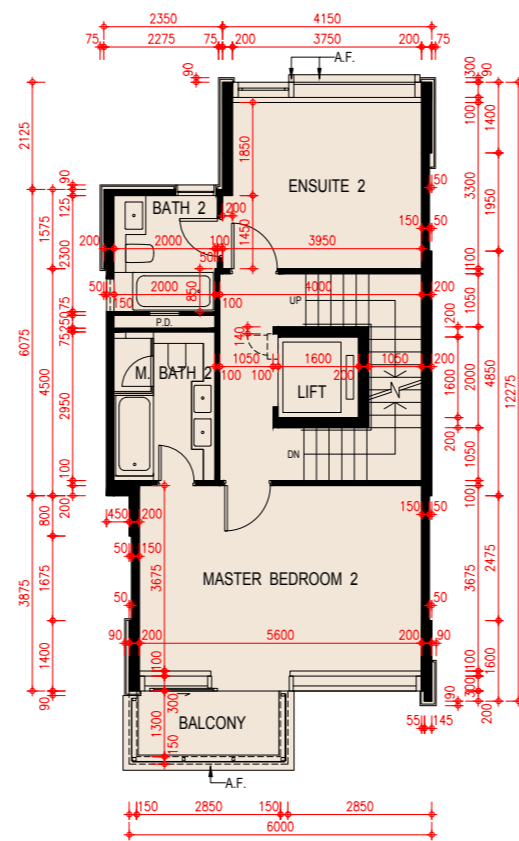
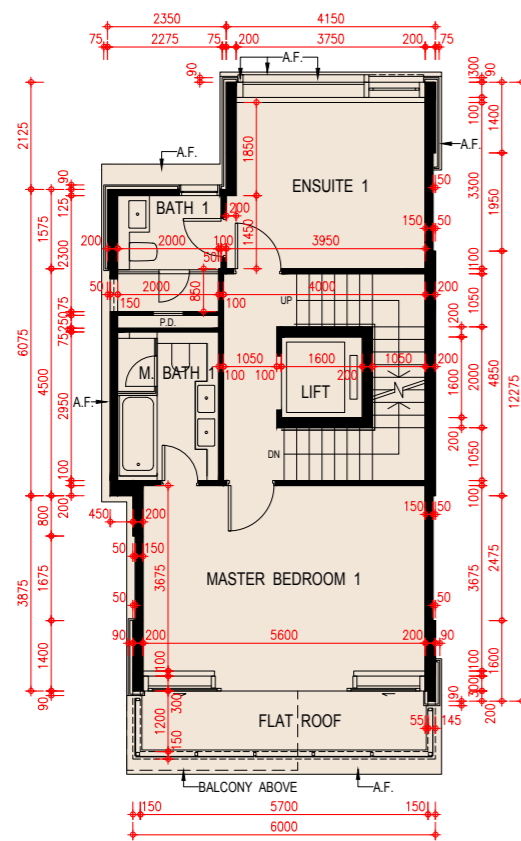

1/F Plan  
一樓平面圖

2/F Plan  
二樓平面圖

Roof Plan  
天台平面圖

Scale: 0M/米 5M/米  
 比例: 5M/米

# FLOOR PLANS OF RESIDENTIAL PROPERTIES IN THE DEVELOPMENT

## 發展項目的住宅物業的樓面平面圖

### House 6 6號洋房

Floor 樓層	The thickness of the floor slabs (excluding plaster) of each House (mm) 每座洋房的樓板(不包括灰泥)的厚度(毫米)	The floor-to-floor height of each House (mm) 每座洋房的層與層之間的高度(毫米)
Basement 地庫	170, 200	4150, 4550, 4850*
G/F 地下	125, 150, 200	3900, 4200, 4600*
1/F 1樓	125, 150, 200	3500, 3600
2/F 2樓	150	3500, 3550, 3900
Roof 天台	150	2350, 2750

The internal areas of the residential properties on the upper floors will generally be slightly larger than those on the lower floors because of the reducing thickness of the structural walls on the upper floors.

因住宅物業的較高樓層的結構牆的厚度遞減，較高樓層的內部面積，一般比較低樓層的內部面積稍大。

**Notes:**

- The dimensions of floor plans are all structural dimensions in millimeter.
- There may be architectural features and/or exposed pipes on external walls of the residential properties. For details, please refer to the latest approved building plans.
- Common pipes exposed and/or enclosed in cladding are located at/adjacent to flat roof and/or external wall of the residential properties. For details, please refer to the latest approved building plans.
- There are ceiling bulkheads and/or sunken slab at living/dining room, bedrooms, ensuites, study rooms, utility rooms, store rooms, corridors, bathrooms, powder rooms, lavatories and kitchen of some residential units for the air-conditioning system and/or mechanical and electrical services.
- Symbols of fittings and fitments shown in the floor plans, such as bathtubs, sink, water closets, shower, sink counter etc are architectural symbols extracted from the latest approved general building plans for general indication only.
- [\*] Inclusive of the thickness of mass concrete fill on sunken slab.

**備註：**

- 平面圖所列之尺寸數字為以毫米標示之建築尺寸。
- 住宅物業的外牆設有建築裝飾及/或外露喉管。詳細資料請參考最新批准之建築圖則。
- 住宅物業的平台及/或外牆設有外露及/或外牆裝飾板內藏之公用喉管。詳細資料請參考最新批准的建築圖則。
- 部份住宅單位的客/飯廳、睡房、套房、書房、工作間、儲物室、走廊、浴室、客廳洗手間、洗手間及廚房有假天花及/或有跌級樓板用以裝置冷氣系統及/或機電設備。
- 樓面平面圖上所顯示的形象裝置符號，例如浴缸、洗滌盆、坐廁、花灑、洗滌盆櫃乃摘自最新的經批准的建築圖則，並只作一般性標誌。
- [\*] 包括跌級樓板上之混凝土填充層厚度。

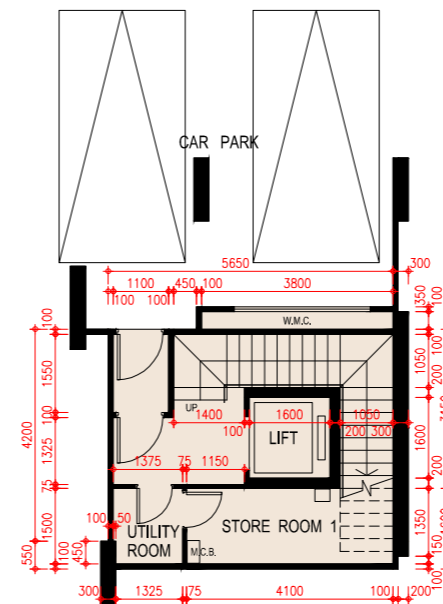

**Basement Plan**  
地庫平面圖

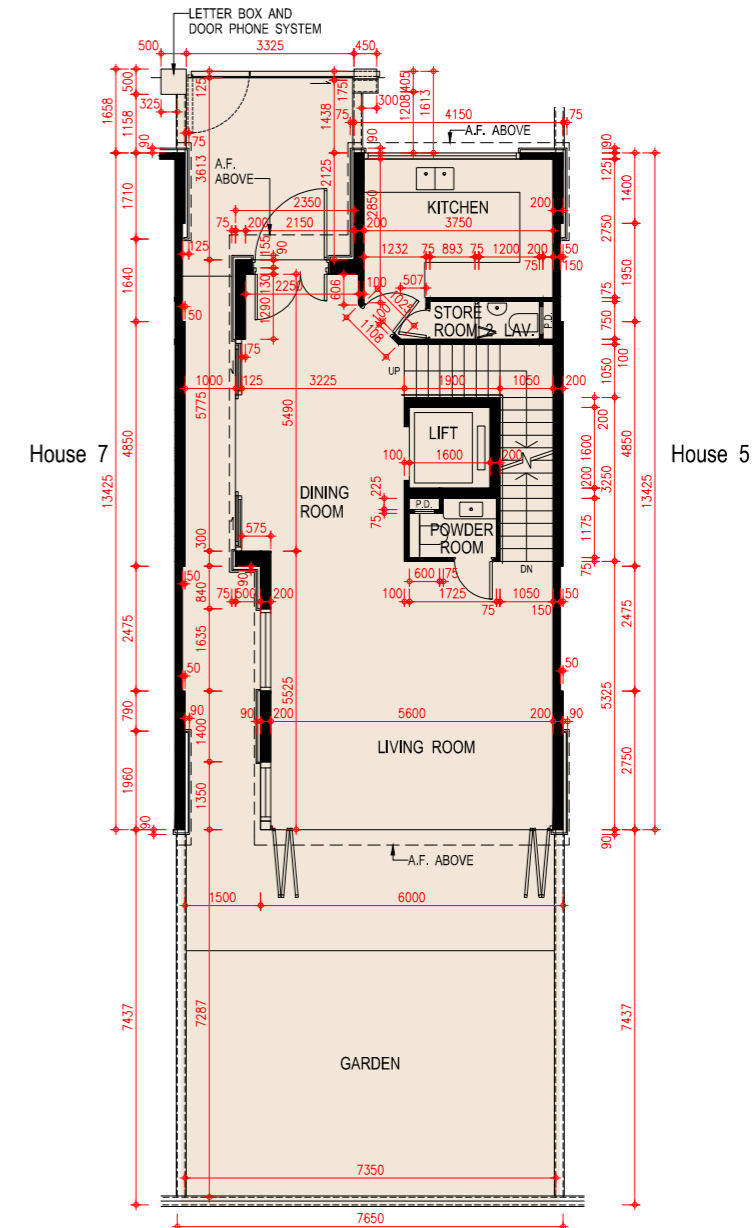

**G/F Plan**  
地下平面圖

Scale: 0M/米  
比例: 5M/米

FLOOR PLANS OF RESIDENTIAL PROPERTIES IN THE DEVELOPMENT

發展項目的住宅物業的樓面平面圖

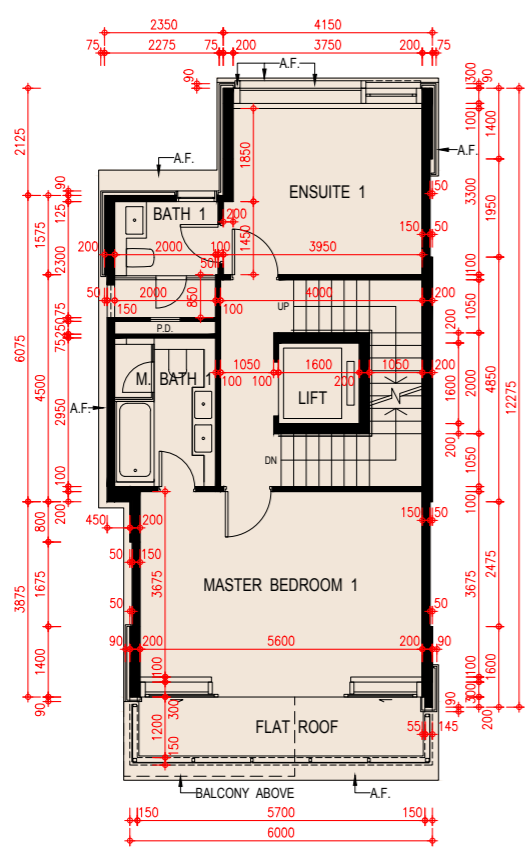

1/F Plan  
一樓平面圖

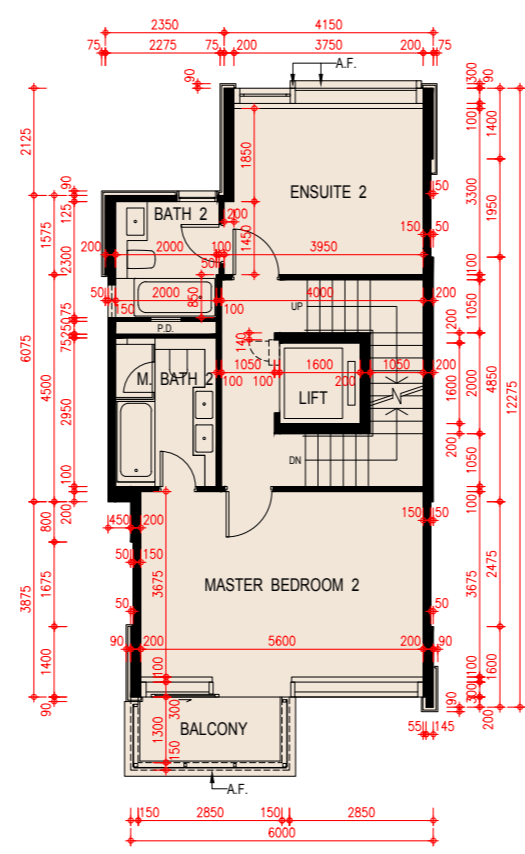

2/F Plan  
二樓平面圖

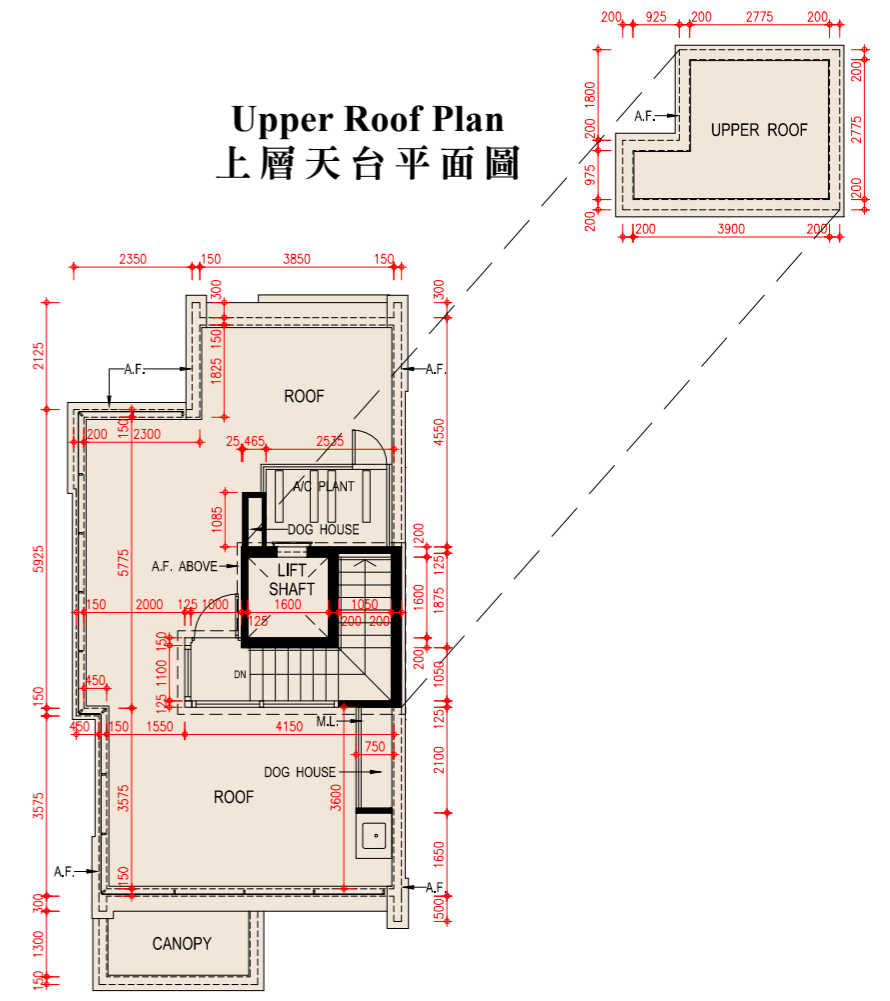

Roof Plan  
天台平面圖

Scale: 0M/米 5M/米  
比例:

# FLOOR PLANS OF RESIDENTIAL PROPERTIES IN THE DEVELOPMENT

## 發展項目的住宅物業的樓面平面圖

### House 7 7號洋房

Floor 樓層	The thickness of the floor slabs (excluding plaster) of each House (mm) 每座洋房的樓板(不包括灰泥)的厚度(毫米)	The floor-to-floor height of each House (mm) 每座洋房的層與層之間的高度(毫米)
Basement 地庫	170, 200	4150, 4550, 4850*
G/F 地下	125, 150, 200	3900, 4200, 4600*
1/F 1樓	125, 150, 200	3500, 3600
2/F 2樓	150	3500, 3550, 3900
Roof 天台	150	2350, 2750

The internal areas of the residential properties on the upper floors will generally be slightly larger than those on the lower floors because of the reducing thickness of the structural walls on the upper floors.

因住宅物業的較高樓層的結構牆的厚度遞減，較高樓層的內部面積，一般比較低樓層的內部面積稍大。

#### Notes:

- The dimensions of floor plans are all structural dimensions in millimeter.
- There may be architectural features and/or exposed pipes on external walls of the residential properties. For details, please refer to the latest approved building plans.
- Common pipes exposed and/or enclosed in cladding are located at/adjacent to flat roof and/or external wall of the residential properties. For details, please refer to the latest approved building plans.
- There are ceiling bulkheads and/or sunken slab at living/dining room, bedrooms, ensuites, study rooms, utility rooms, store rooms, corridors, bathrooms, powder rooms, lavatories and kitchen of some residential units for the air-conditioning system and/or mechanical and electrical services.
- Symbols of fittings and fitments shown in the floor plans, such as bathtubs, sink, water closets, shower, sink counter etc are architectural symbols extracted from the latest approved general building plans for general indication only.
- [\*] Inclusive of the thickness of mass concrete fill on sunken slab.

#### 備註：

- 平面圖所列之尺寸數字為以毫米標示之建築尺寸。
- 住宅物業的外牆設有建築裝飾及/或外露喉管。詳細資料請參考最新批准之建築圖則。
- 住宅物業的平台及/或外牆設有外露及/或外牆裝飾板內藏之公用喉管。詳細資料請參考最新批准的建築圖則。
- 部份住宅單位的客/飯廳、睡房、套房、書房、工作間、儲物室、走廊、浴室、客廳洗手間、洗手間及廚房有假天花及/或有跌級樓板用以裝置冷氣系統及/或機電設備。
- 樓面平面圖上所顯示的形象裝置符號，例如浴缸、洗滌盆、坐廁、花灑、洗滌盆櫃乃摘自最新的經批准的建築圖則，並只作一般性標誌。
- [\*] 包括跌級樓板上之混凝土填充層厚度。

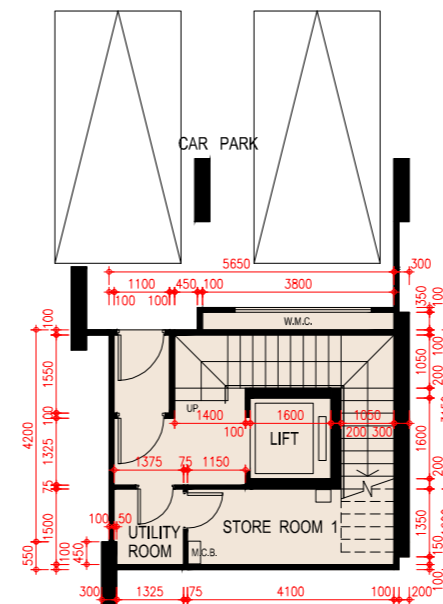

**Basement Plan**  
地庫平面圖

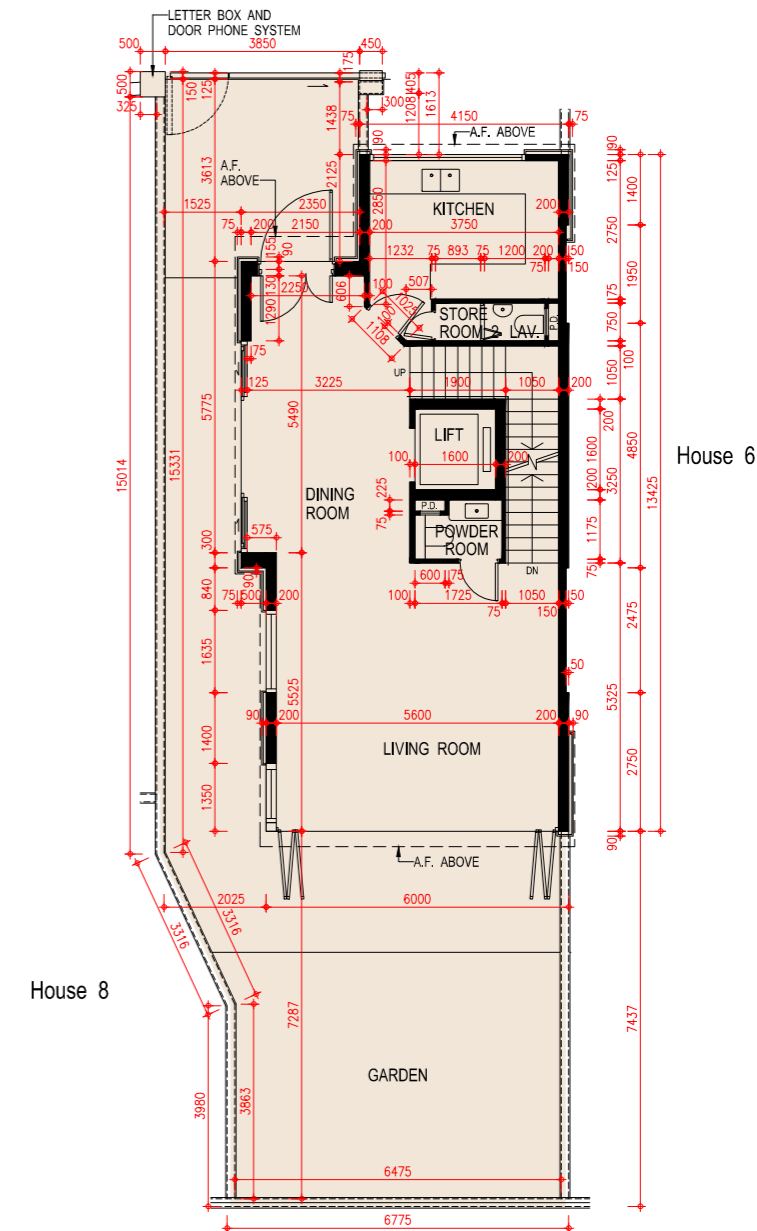

**G/F Plan**  
地下平面圖

Scale: 0M/米  
比例: 5M/米



FLOOR PLANS OF RESIDENTIAL PROPERTIES IN THE DEVELOPMENT

發展項目的住宅物業的樓面平面圖

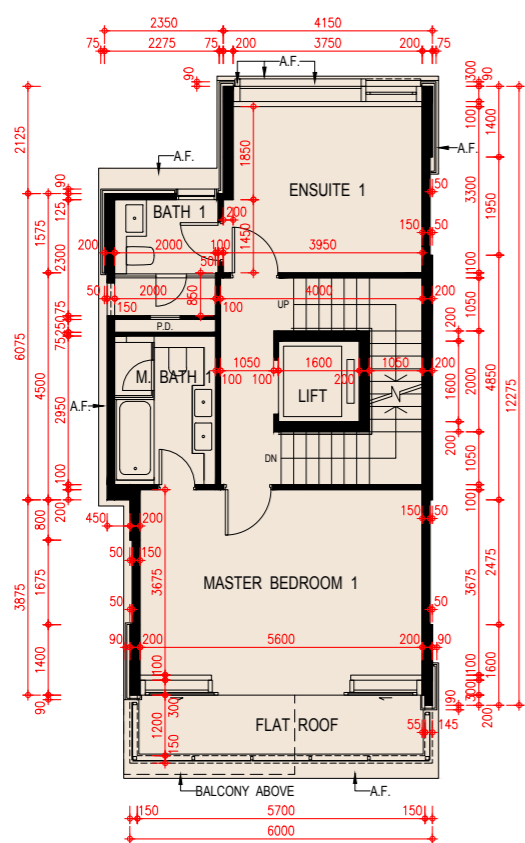

1/F Plan  
一樓平面圖

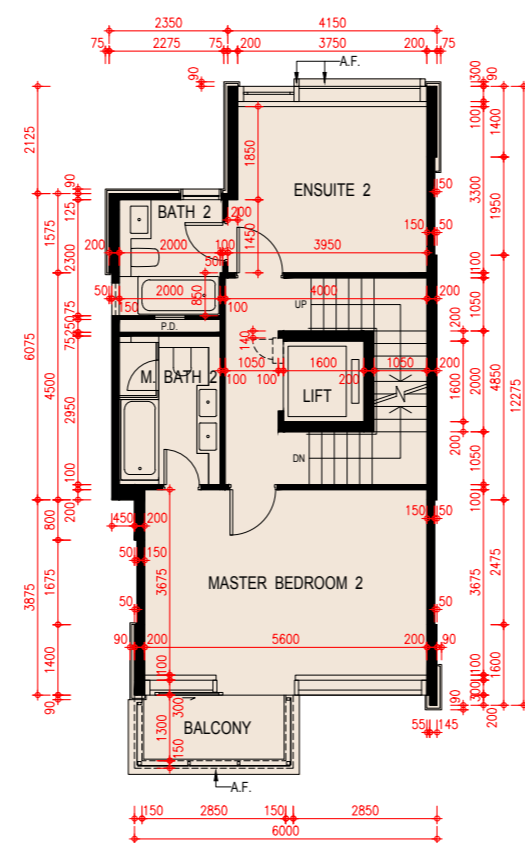

2/F Plan  
二樓平面圖

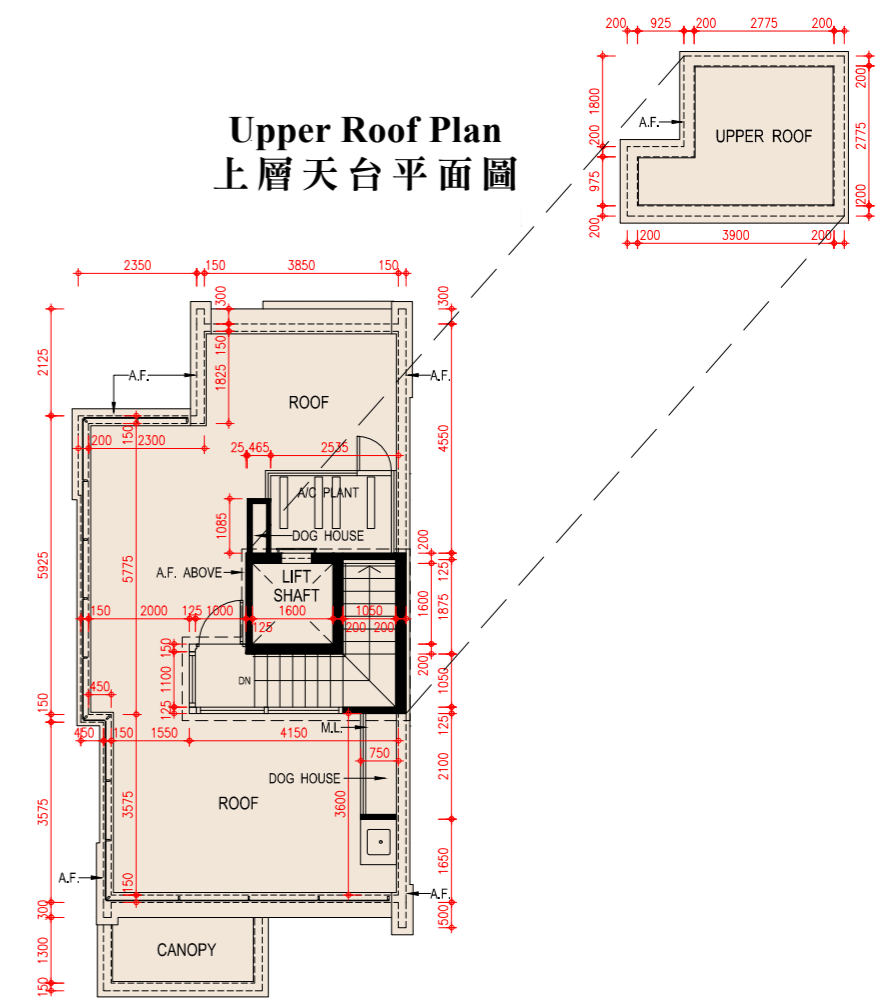

Roof Plan  
天台平面圖

Scale: 0M/米 5M/米  
比例:

# FLOOR PLANS OF RESIDENTIAL PROPERTIES IN THE DEVELOPMENT

## 發展項目的住宅物業的樓面平面圖

### House 8 8號洋房

Floor 樓層	The thickness of the floor slabs (excluding plaster) of each House (mm) 每座洋房的樓板(不包括灰泥)的厚度(毫米)	The floor-to-floor height of each House (mm) 每座洋房的層與層之間的高度(毫米)
Basement 地庫	170, 200	4550, 4850*
G/F 地下	150, 200	3900, 4200, 4600*
1/F 1樓	150, 200	3500
2/F 2樓	150, 200	3500, 3550, 3900
Roof 天台	150	2350

The internal areas of the residential properties on the upper floors will generally be slightly larger than those on the lower floors because of the reducing thickness of the structural walls on the upper floors.

因住宅物業的較高樓層的結構牆的厚度遞減，較高樓層的內部面積，一般比較低樓層的內部面積稍大。

#### Notes:

- The dimensions of floor plans are all structural dimensions in millimeter.
- There may be architectural features and/or exposed pipes on external walls of the residential properties. For details, please refer to the latest approved building plans.
- Common pipes exposed and/or enclosed in cladding are located at/adjacent to flat roof and/or external wall of the residential properties. For details, please refer to the latest approved building plans.
- There are ceiling bulkheads and/or sunken slab at living/dining room, bedrooms, ensuites, study rooms, utility rooms, store rooms, corridors, bathrooms, powder rooms, lavatories and kitchen of some residential units for the air-conditioning system and/or mechanical and electrical services.
- Symbols of fittings and fitments shown in the floor plans, such as bathtubs, sink, water closets, shower, sink counter etc are architectural symbols extracted from the latest approved general building plans for general indication only.
- [\*] Inclusive of the thickness of mass concrete fill on sunken slab.

#### 備註：

- 平面圖所列之尺寸數字為以毫米標示之建築尺寸。
- 住宅物業的外牆設有建築裝飾及/或外露喉管。詳細資料請參考最新批准之建築圖則。
- 住宅物業的平台及/或外牆設有外露及/或外牆裝飾板內藏之公用喉管。詳細資料請參考最新批准的建築圖則。
- 部份住宅單位的客/飯廳、睡房、套房、書房、工作間、儲物室、走廊、浴室、客廳洗手間、洗手間及廚房有假天花及/或有跌級樓板用以裝置冷氣系統及/或機電設備。
- 樓面平面圖上所顯示的形象裝置符號，例如浴缸、洗滌盆、坐廁、花灑、洗滌盆櫃乃摘自最新的經批准的建築圖則，並只作一般性標誌。
- [\*] 包括跌級樓板上之混凝土填充層厚度。

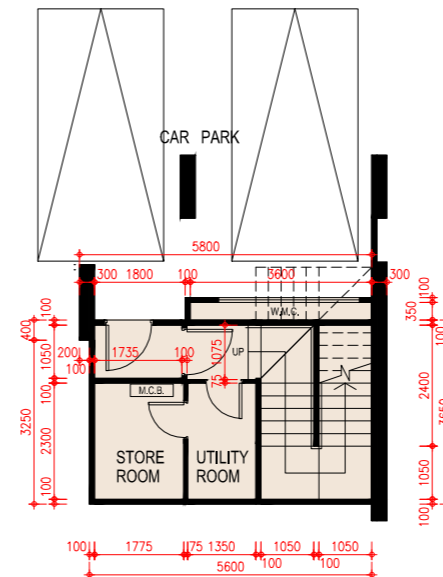
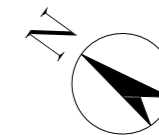

**Basement Plan**  
地庫平面圖

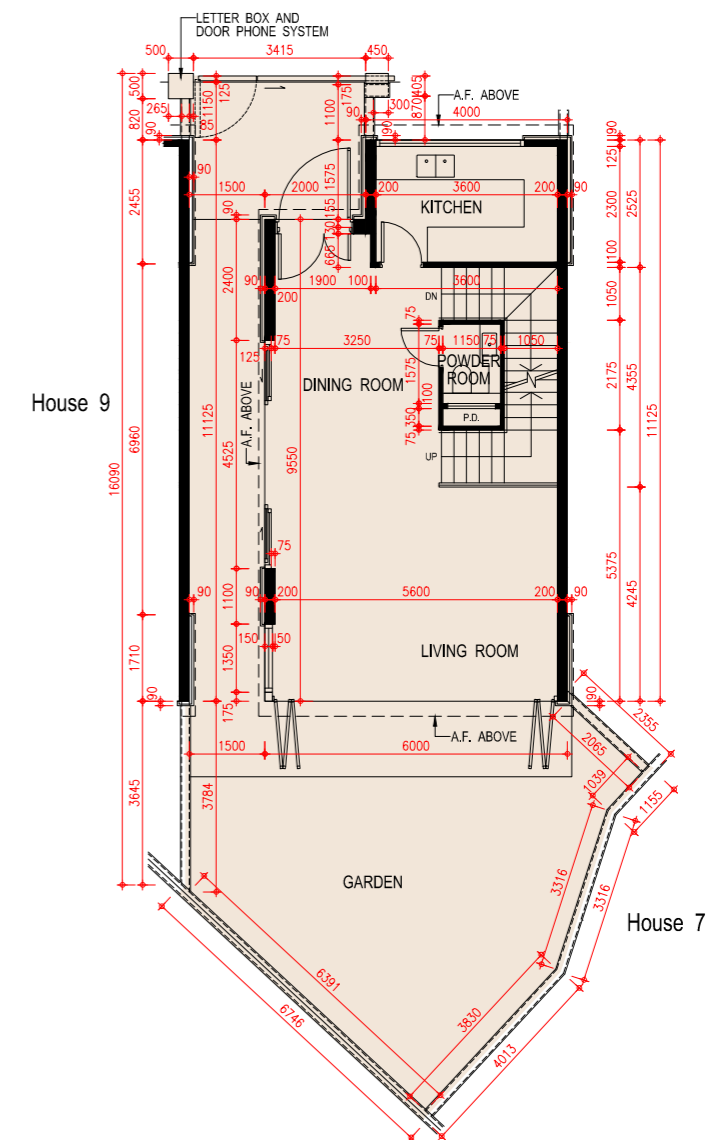

**G/F Plan**  
地下平面圖

Scale: 0M/米 5M/米  
比例:

**FLOOR PLANS OF RESIDENTIAL PROPERTIES IN THE DEVELOPMENT**  
**發展項目的住宅物業的樓面平面圖**

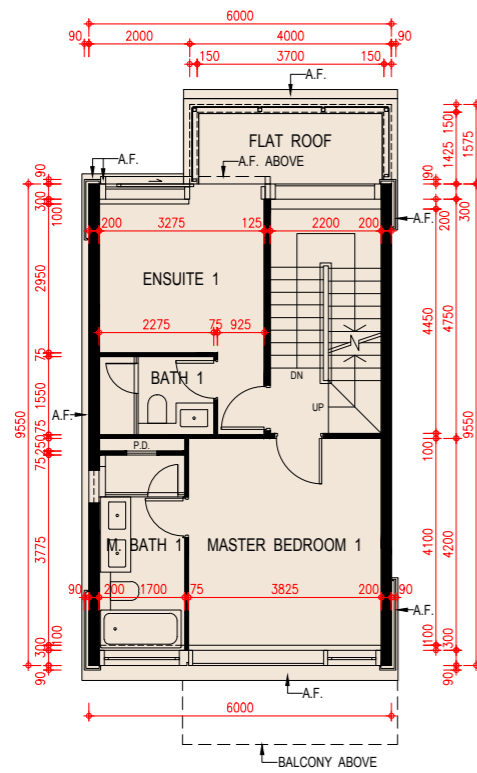

**1/F Plan**  
**一樓平面圖**

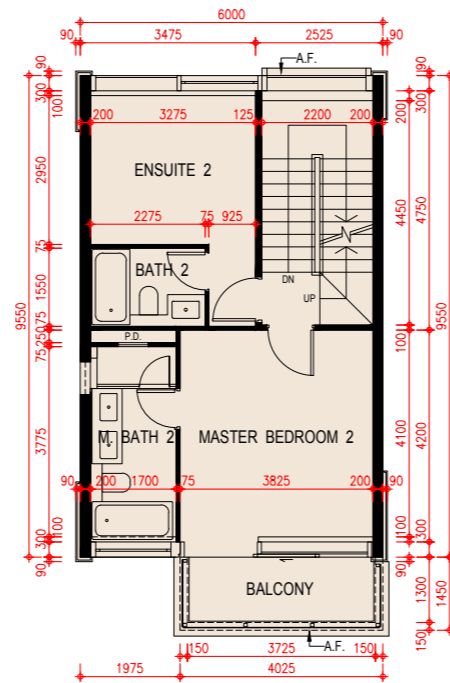

**2/F Plan**  
**二樓平面圖**

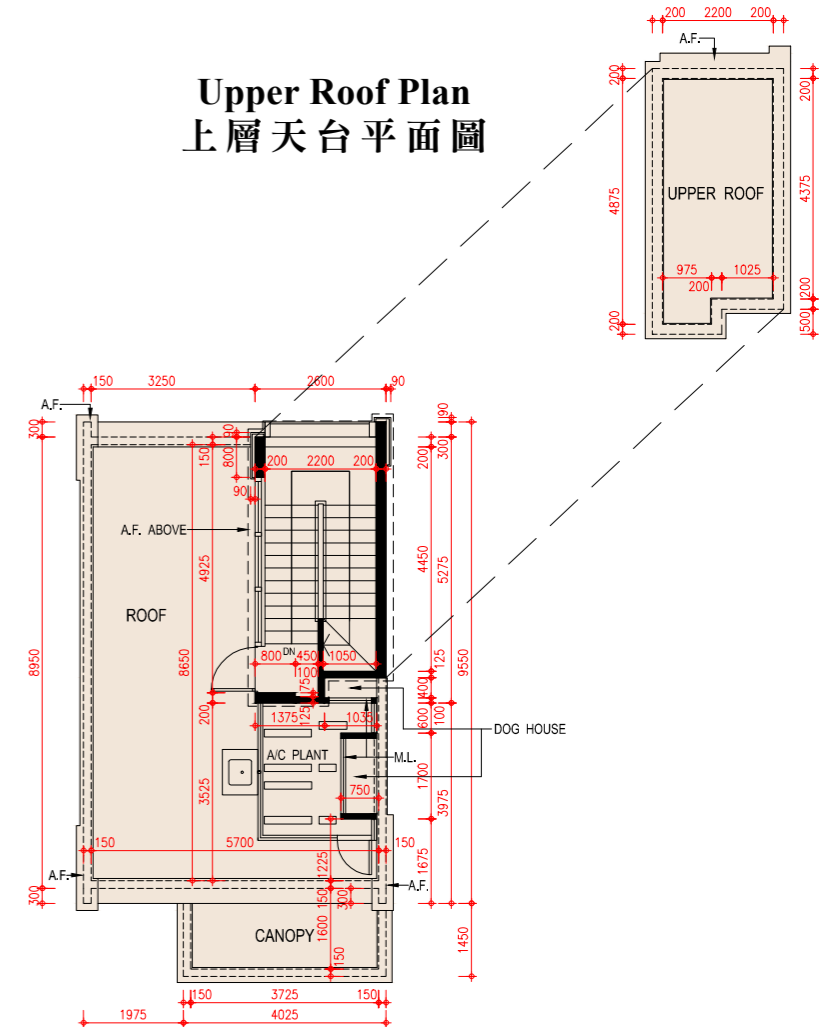

**Roof Plan**  
**天台平面圖**

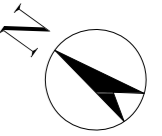

Scale: 0M/米 5M/米  
 比例: 5M/米

# FLOOR PLANS OF RESIDENTIAL PROPERTIES IN THE DEVELOPMENT

## 發展項目的住宅物業的樓面平面圖

### House 9 9號洋房

Floor 樓層	The thickness of the floor slabs (excluding plaster) of each House (mm) 每座洋房的樓板(不包括灰泥)的厚度(毫米)	The floor-to-floor height of each House (mm) 每座洋房的層與層之間的高度(毫米)
Basement 地庫	170, 200	4550, 4850*
G/F 地下	150, 200	3900, 4200, 4600*
1/F 1樓	150, 200	3500
2/F 2樓	150, 200	3500, 3550, 3900
Roof 天台	150	2350

The internal areas of the residential properties on the upper floors will generally be slightly larger than those on the lower floors because of the reducing thickness of the structural walls on the upper floors.

因住宅物業的較高樓層的結構牆的厚度遞減，較高樓層的內部面積，一般比較低樓層的內部面積稍大。

#### Notes:

- The dimensions of floor plans are all structural dimensions in millimeter.
- There may be architectural features and/or exposed pipes on external walls of the residential properties. For details, please refer to the latest approved building plans.
- Common pipes exposed and/or enclosed in cladding are located at/adjacent to flat roof and/or external wall of the residential properties. For details, please refer to the latest approved building plans.
- There are ceiling bulkheads and/or sunken slab at living/dining room, bedrooms, ensuites, study rooms, utility rooms, store rooms, corridors, bathrooms, powder rooms, lavatories and kitchen of some residential units for the air-conditioning system and/or mechanical and electrical services.
- Symbols of fittings and fitments shown in the floor plans, such as bathtubs, sink, water closets, shower, sink counter etc are architectural symbols extracted from the latest approved general building plans for general indication only.
- [\*] Inclusive of the thickness of mass concrete fill on sunken slab.

#### 備註：

- 平面圖所列之尺寸數字為以毫米標示之建築尺寸。
- 住宅物業的外牆設有建築裝飾及/或外露喉管。詳細資料請參考最新批准之建築圖則。
- 住宅物業的平台及/或外牆設有外露及/或外牆裝飾板內藏之公用喉管。詳細資料請參考最新批准的建築圖則。
- 部份住宅單位的客/飯廳、睡房、套房、書房、工作間、儲物室、走廊、浴室、客廳洗手間、洗手間及廚房有假天花及/或有跌級樓板用以裝置冷氣系統及/或機電設備。
- 樓面平面圖上所顯示的形象裝置符號，例如浴缸、洗滌盆、坐廁、花灑、洗滌盆櫃乃摘自最新的經批准的建築圖則，並只作一般性標誌。
- [\*] 包括跌級樓板上之混凝土填充層厚度。

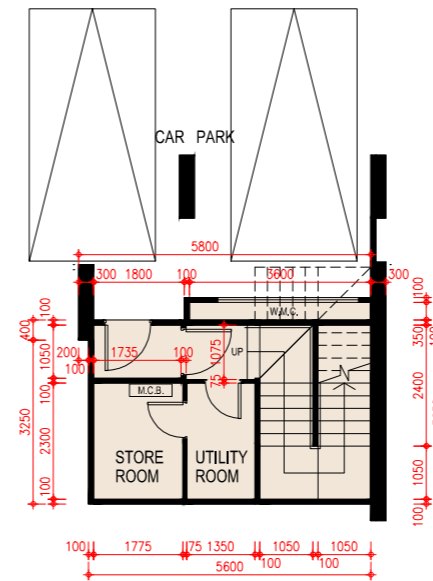
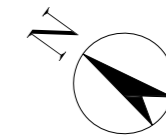

**Basement Plan**  
地庫平面圖

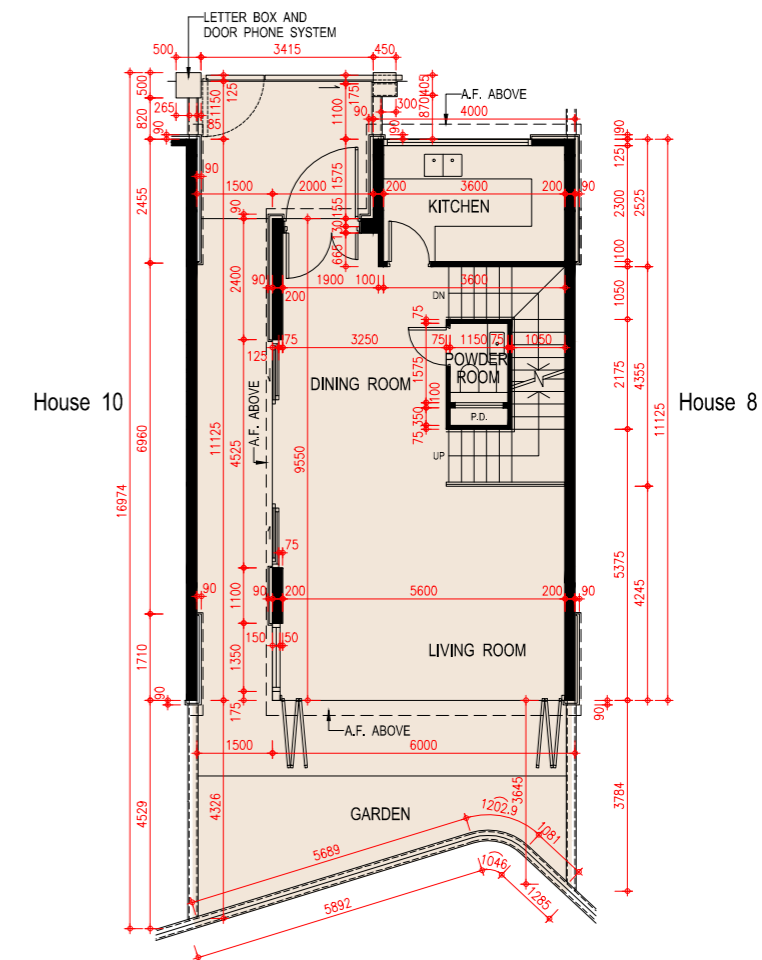

**G/F Plan**  
地下平面圖

Scale: 0M/米  
比例: 0 5M/米



**FLOOR PLANS OF RESIDENTIAL PROPERTIES IN THE DEVELOPMENT**  
**發展項目的住宅物業的樓面平面圖**

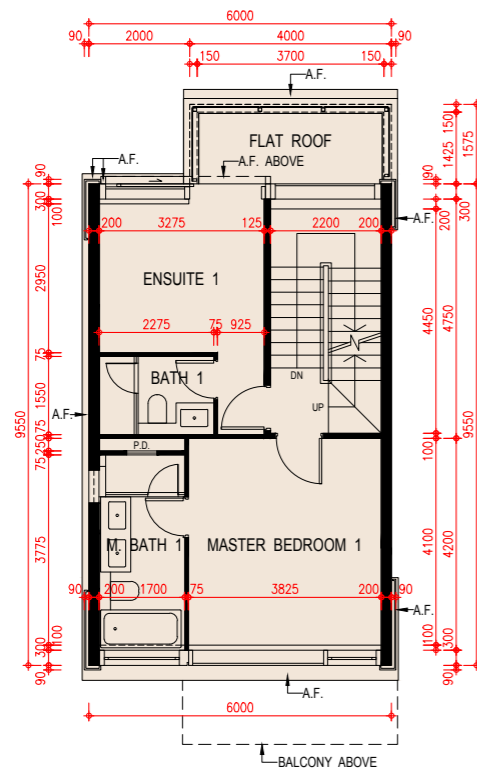

**1/F Plan**  
**一樓平面圖**

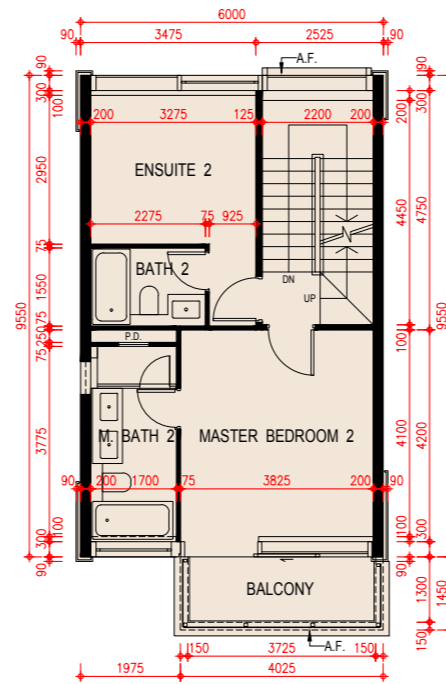

**2/F Plan**  
**二樓平面圖**

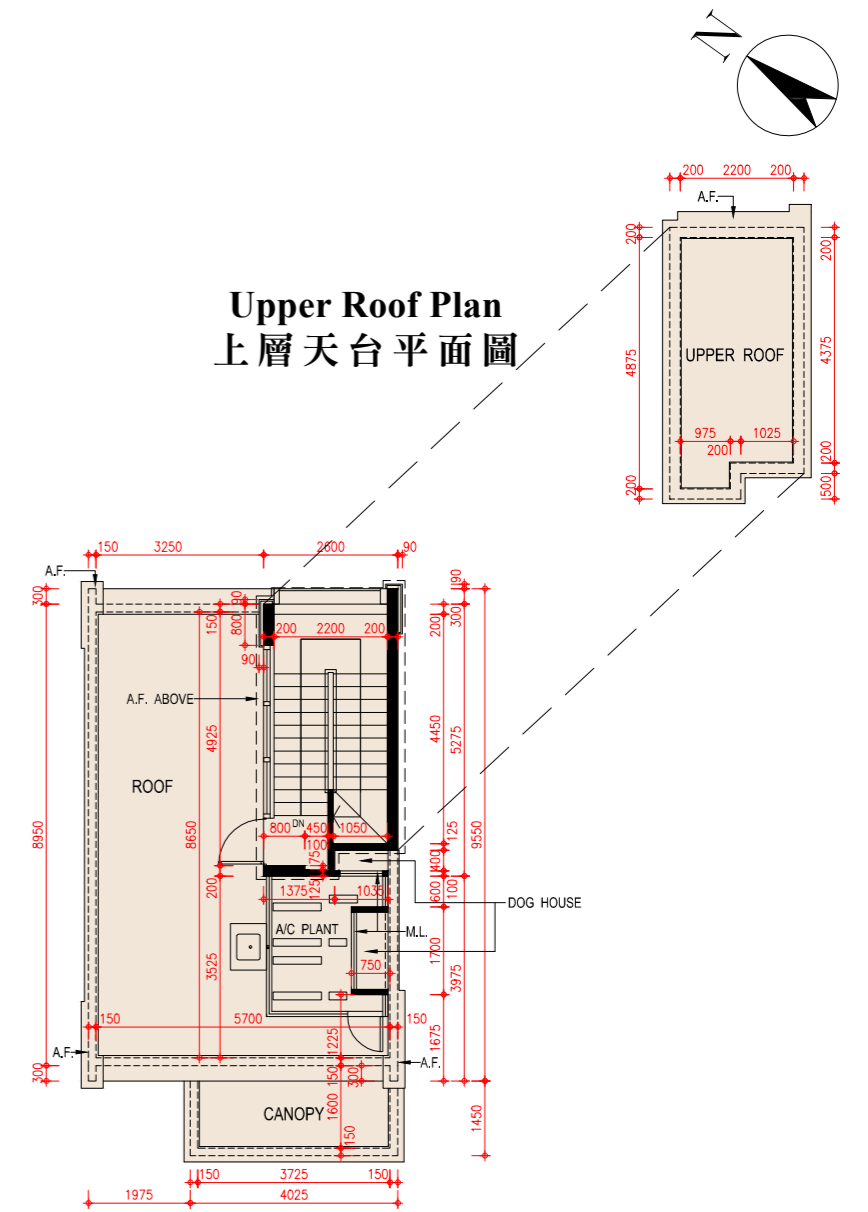

**Roof Plan**  
**天台平面圖**

Scale: 0M/米 5M/米  
 比例: 5M/米

# FLOOR PLANS OF RESIDENTIAL PROPERTIES IN THE DEVELOPMENT

## 發展項目的住宅物業的樓面平面圖

### House 10 10號洋房

Floor 樓層	The thickness of the floor slabs (excluding plaster) of each House (mm) 每座洋房的樓板(不包括灰泥)的厚度(毫米)	The floor-to-floor height of each House (mm) 每座洋房的層與層之間的高度(毫米)
Basement 地庫	170, 200	4550, 4850*
G/F 地下	150, 200	3900, 4200, 4600*
1/F 1樓	150, 200	3500
2/F 2樓	150, 200	3500, 3550, 3900
Roof 天台	150	2350

The internal areas of the residential properties on the upper floors will generally be slightly larger than those on the lower floors because of the reducing thickness of the structural walls on the upper floors.

因住宅物業的較高樓層的結構牆的厚度遞減，較高樓層的內部面積，一般比較低樓層的內部面積稍大。

#### Notes:

- The dimensions of floor plans are all structural dimensions in millimeter.
- There may be architectural features and/or exposed pipes on external walls of the residential properties. For details, please refer to the latest approved building plans.
- Common pipes exposed and/or enclosed in cladding are located at/adjacent to flat roof and/or external wall of the residential properties. For details, please refer to the latest approved building plans.
- There are ceiling bulkheads and/or sunken slab at living/dining room, bedrooms, ensuites, study rooms, utility rooms, store rooms, corridors, bathrooms, powder rooms, lavatories and kitchen of some residential units for the air-conditioning system and/or mechanical and electrical services.
- Symbols of fittings and fitments shown in the floor plans, such as bathtubs, sink, water closets, shower, sink counter etc are architectural symbols extracted from the latest approved general building plans for general indication only.
- [\*] Inclusive of the thickness of mass concrete fill on sunken slab.

#### 備註：

- 平面圖所列之尺寸數字為以毫米標示之建築尺寸。
- 住宅物業的外牆設有建築裝飾及/或外露喉管。詳細資料請參考最新批准之建築圖則。
- 住宅物業的平台及/或外牆設有外露及/或外牆裝飾板內藏之公用喉管。詳細資料請參考最新批准的建築圖則。
- 部份住宅單位的客/飯廳、睡房、套房、書房、工作間、儲物室、走廊、浴室、客廳洗手間、洗手間及廚房有假天花及/或有跌級樓板用以裝置冷氣系統及/或機電設備。
- 樓面平面圖上所顯示的形象裝置符號，例如浴缸、洗滌盆、坐廁、花灑、洗滌盆櫃乃摘自最新的經批准的建築圖則，並只作一般性標誌。
- [\*] 包括跌級樓板上之混凝土填充層厚度。

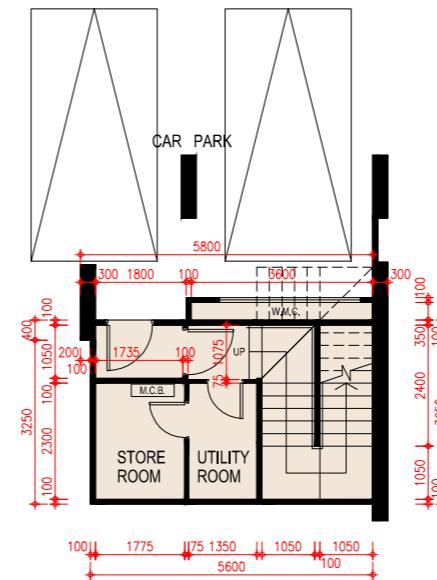
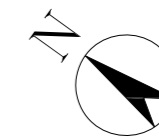

**Basement Plan**  
地庫平面圖

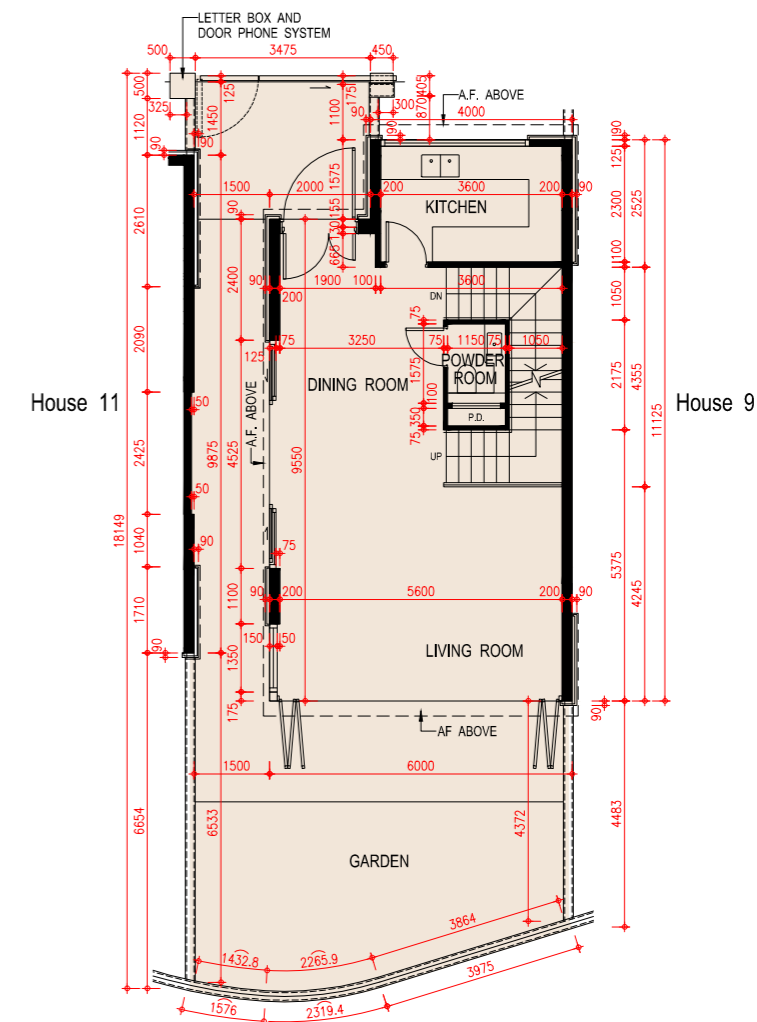

**G/F Plan**  
地下平面圖

Scale: 0M/米  
比例: 0 5M/米

**FLOOR PLANS OF RESIDENTIAL PROPERTIES IN THE DEVELOPMENT**  
**發展項目的住宅物業的樓面平面圖**

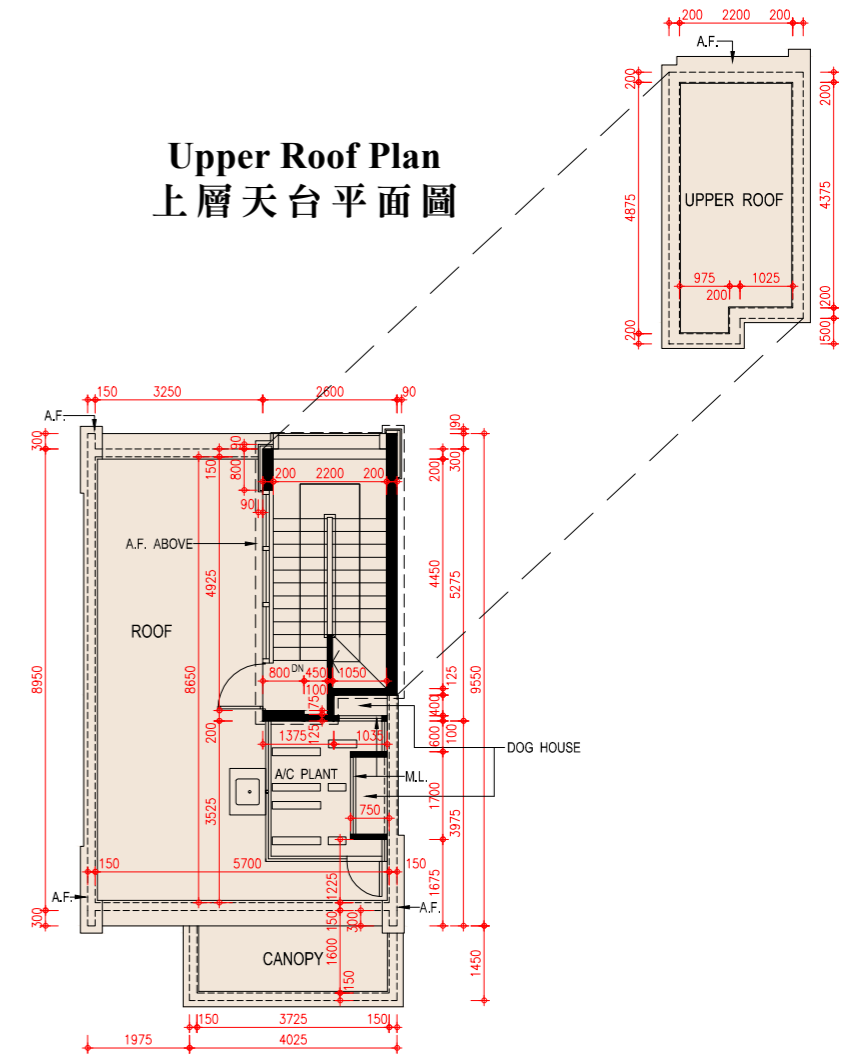
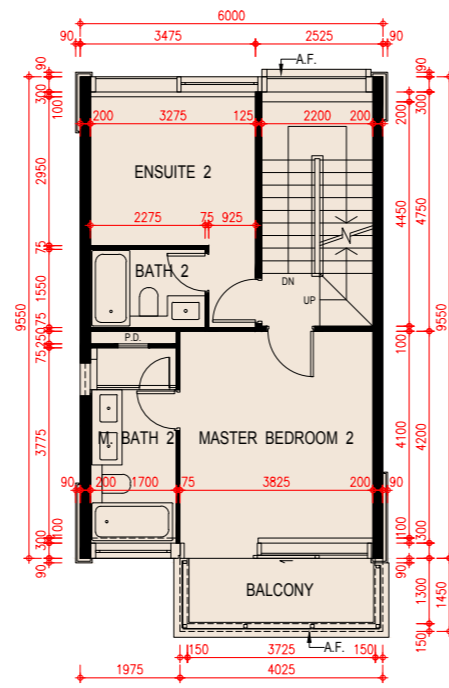
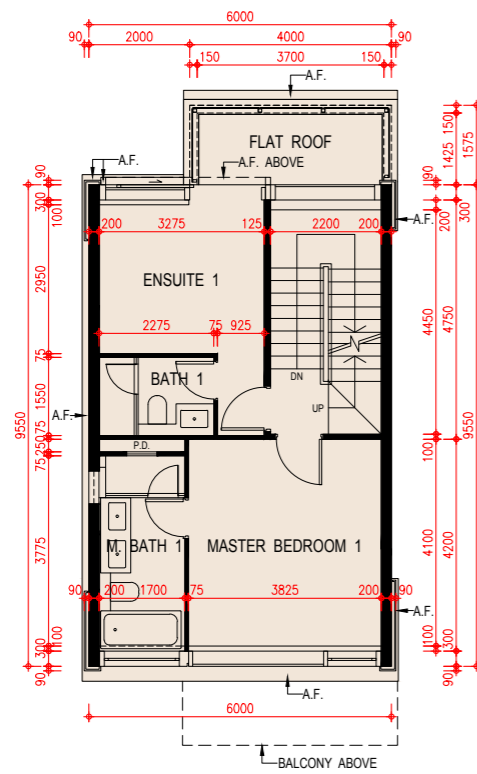
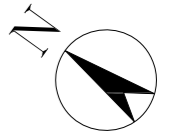

**1/F Plan**  
一樓平面圖

**2/F Plan**  
二樓平面圖

**Roof Plan**  
天台平面圖

Scale: 0M/米 5M/米  
 比例:

# FLOOR PLANS OF RESIDENTIAL PROPERTIES IN THE DEVELOPMENT

## 發展項目的住宅物業的樓面平面圖

### House 11 11號洋房

Floor 樓層	The thickness of the floor slabs (excluding plaster) of each House (mm) 每座洋房的樓板(不包括灰泥)的厚度(毫米)	The floor-to-floor height of each House (mm) 每座洋房的層與層之間的高度(毫米)
Basement 地庫	170, 200	4150, 4550, 4850*
G/F 地下	125, 150, 200	3900, 4200, 4600*
1/F 1樓	125, 150, 200	3200, 3400, 3500, 3950*
2/F 2樓	150, 200	3500, 3900
Roof 天台	150	2350, 2750

The internal areas of the residential properties on the upper floors will generally be slightly larger than those on the lower floors because of the reducing thickness of the structural walls on the upper floors.

因住宅物業的較高樓層的結構牆的厚度遞減，較高樓層的內部面積，一般比較低樓層的內部面積稍大。

#### Notes:

- The dimensions of floor plans are all structural dimensions in millimeter.
- There may be architectural features and/or exposed pipes on external walls of the residential properties. For details, please refer to the latest approved building plans.
- Common pipes exposed and/or enclosed in cladding are located at/adjacent to flat roof and/or external wall of the residential properties. For details, please refer to the latest approved building plans.
- There are ceiling bulkheads and/or sunken slab at living/dining room, bedrooms, ensuites, study rooms, utility rooms, store rooms, corridors, bathrooms, powder rooms, lavatories and kitchen of some residential units for the air-conditioning system and/or mechanical and electrical services.
- Symbols of fittings and fitments shown in the floor plans, such as bathtubs, sink, water closets, shower, sink counter etc are architectural symbols extracted from the latest approved general building plans for general indication only.
- [\*] Inclusive of the thickness of mass concrete fill on sunken slab.

#### 備註：

- 平面圖所列之尺寸數字為以毫米標示之建築尺寸。
- 住宅物業的外牆設有建築裝飾及/或外露喉管。詳細資料請參考最新批准之建築圖則。
- 住宅物業的平台及/或外牆設有外露及/或外牆裝飾板內藏之公用喉管。詳細資料請參考最新批准的建築圖則。
- 部份住宅單位的客/飯廳、睡房、套房、書房、工作間、儲物室、走廊、浴室、客廳洗手間、洗手間及廚房有假天花及/或有跌級樓板用以裝置冷氣系統及/或機電設備。
- 樓面平面圖上所顯示的形象裝置符號，例如浴缸、洗滌盆、坐廁、花灑、洗滌盆櫃乃摘自最新的經批准的建築圖則，並只作一般性標誌。
- [\*] 包括跌級樓板上之混凝土填充層厚度。

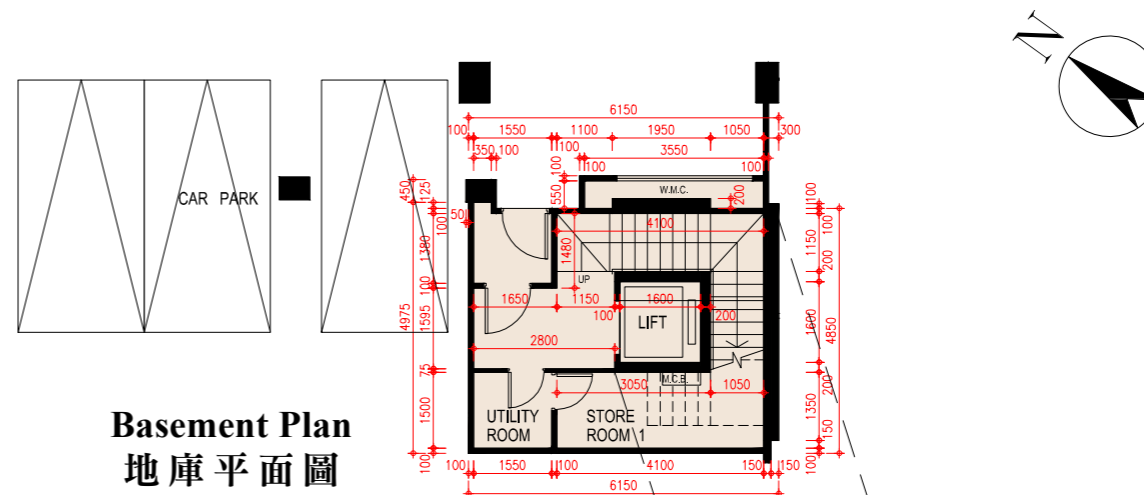

Basement Plan  
地庫平面圖

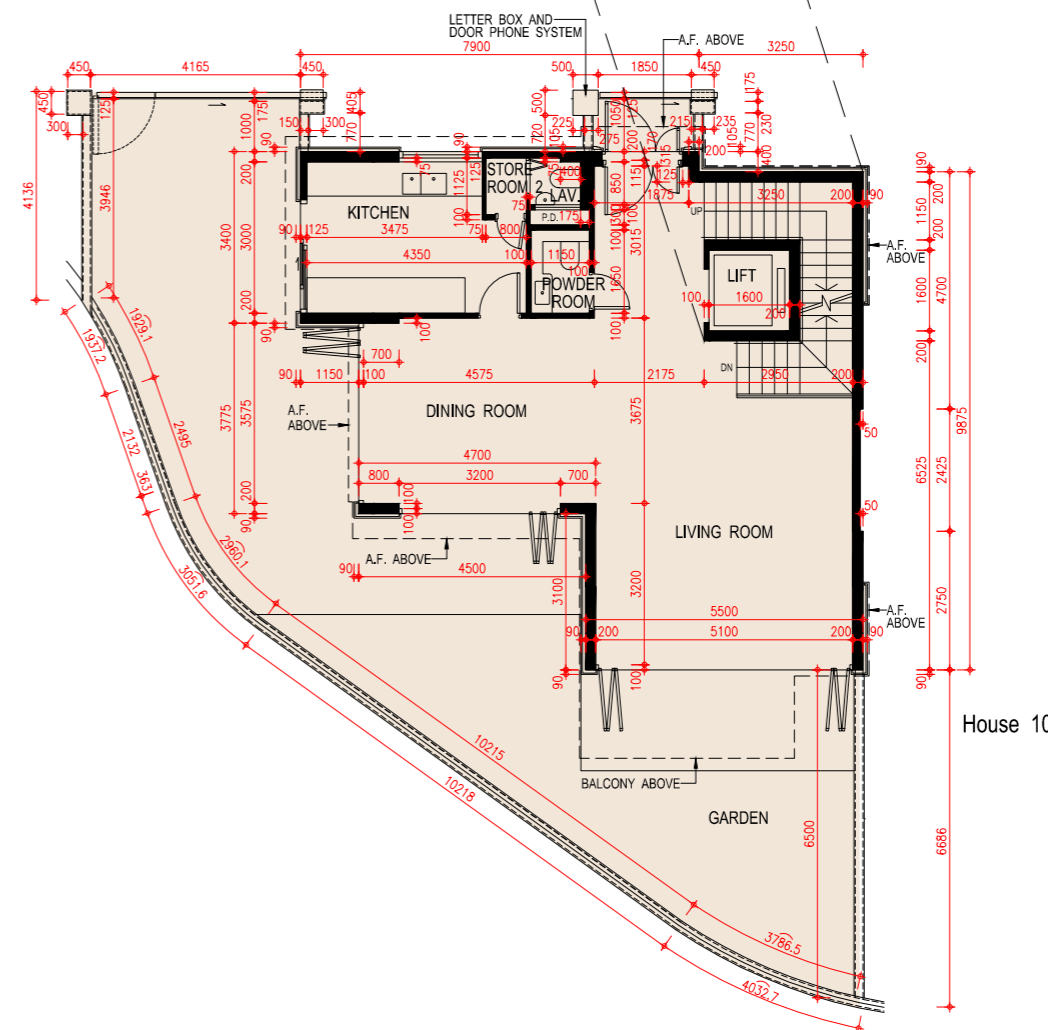

G/F Plan  
地下平面圖

Scale: 0M/米 5M/米  
比例: 1:5000



FLOOR PLANS OF RESIDENTIAL PROPERTIES IN THE DEVELOPMENT  
發展項目的住宅物業的樓面平面圖

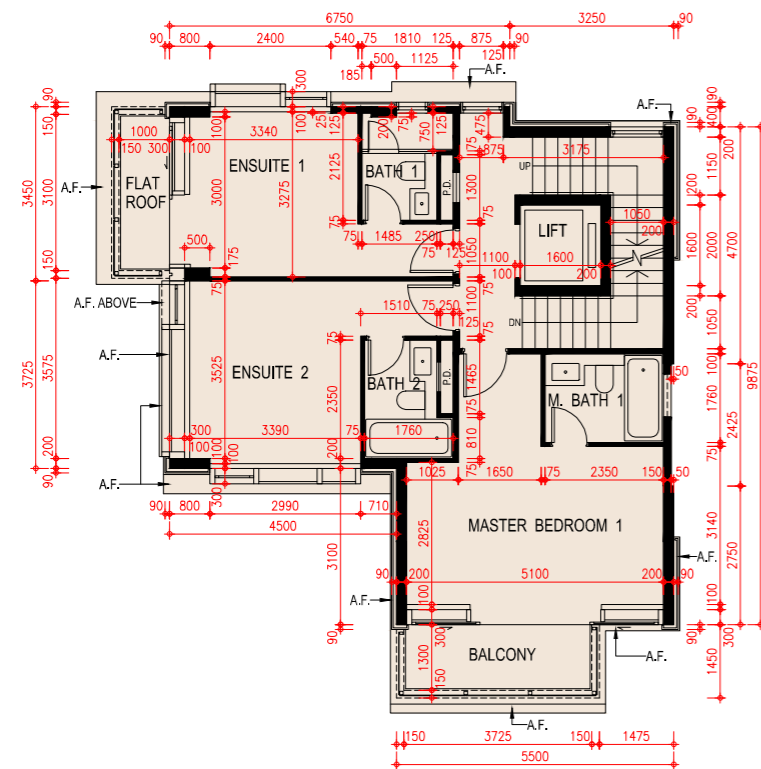
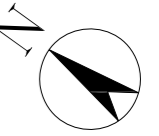

1/F Plan  
一樓平面圖

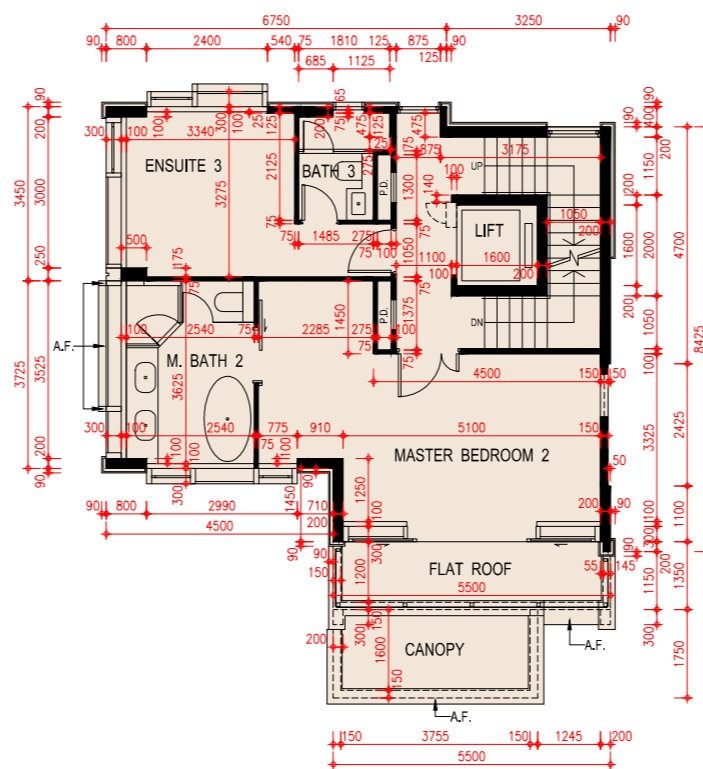

2/F Plan  
二樓平面圖

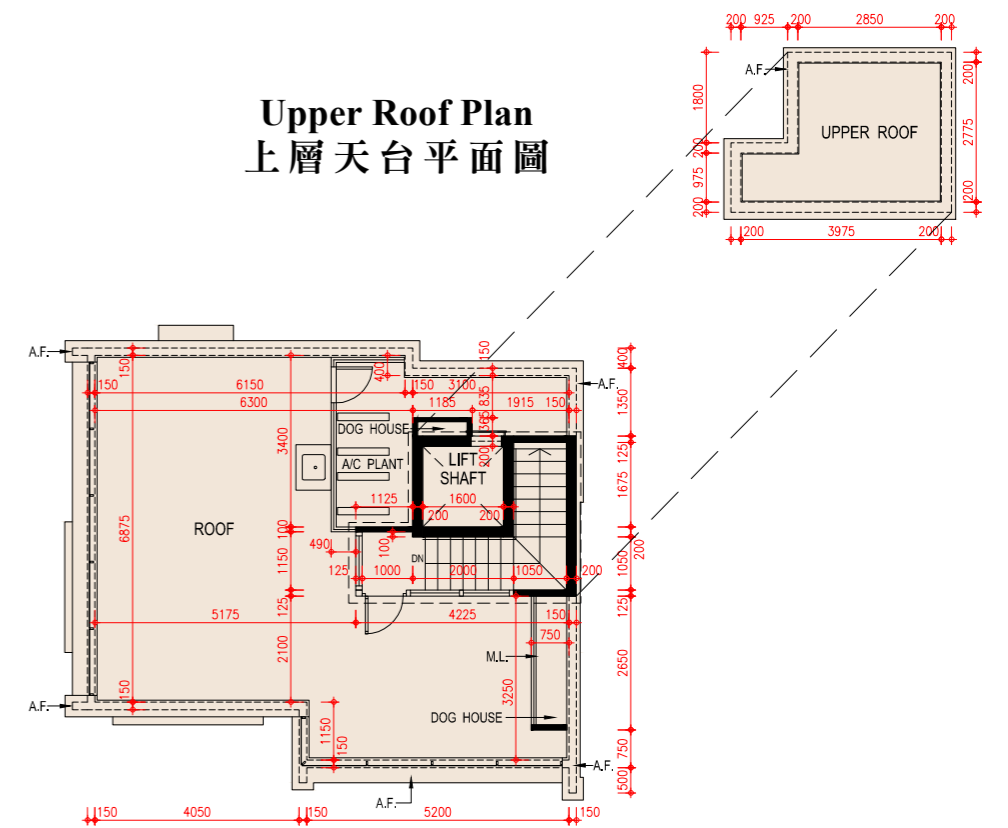

Upper Roof Plan  
上層天台平面圖

Scale: 0M/米 5M/米  
比例:

# FLOOR PLANS OF RESIDENTIAL PROPERTIES IN THE DEVELOPMENT

## 發展項目的住宅物業的樓面平面圖

### House 12 12號洋房

Floor 樓層	The thickness of the floor slabs (excluding plaster) of each House (mm) 每座洋房的樓板(不包括灰泥)的厚度(毫米)	The floor-to-floor height of each House (mm) 每座洋房的層與層之間的高度(毫米)
Basement 地庫	170, 200	4550, 4850*
G/F 地下	150, 200	4200, 4600*
1/F 1樓	150, 200	3500
2/F 2樓	150, 200	3475, 3500, 3900
Roof 天台	150	2350

The internal areas of the residential properties on the upper floors will generally be slightly larger than those on the lower floors because of the reducing thickness of the structural walls on the upper floors.

因住宅物業的較高樓層的結構牆的厚度遞減，較高樓層的內部面積，一般比較低樓層的內部面積稍大。

#### Notes:

- The dimensions of floor plans are all structural dimensions in millimeter.
- There may be architectural features and/or exposed pipes on external walls of the residential properties. For details, please refer to the latest approved building plans.
- Common pipes exposed and/or enclosed in cladding are located at/adjacent to flat roof and/or external wall of the residential properties. For details, please refer to the latest approved building plans.
- There are ceiling bulkheads and/or sunken slab at living/dining room, bedrooms, ensuites, study rooms, utility rooms, store rooms, corridors, bathrooms, powder rooms, lavatories and kitchen of some residential units for the air-conditioning system and/or mechanical and electrical services.
- Symbols of fittings and fitments shown in the floor plans, such as bathtubs, sink, water closets, shower, sink counter etc are architectural symbols extracted from the latest approved general building plans for general indication only.
- [\*] Inclusive of the thickness of mass concrete fill on sunken slab.

#### 備註：

- 平面圖所列之尺寸數字為以毫米標示之建築尺寸。
- 住宅物業的外牆設有建築裝飾及/或外露喉管。詳細資料請參考最新批准之建築圖則。
- 住宅物業的平台及/或外牆設有外露及/或外牆裝飾板內藏之公用喉管。詳細資料請參考最新批准的建築圖則。
- 部份住宅單位的客/飯廳、睡房、套房、書房、工作間、儲物室、走廊、浴室、客廳洗手間、洗手間及廚房有假天花及/或有跌級樓板用以裝置冷氣系統及/或機電設備。
- 樓面平面圖上所顯示的形象裝置符號，例如浴缸、洗滌盆、坐廁、花灑、洗滌盆櫃乃摘自最新的經批准的建築圖則，並只作一般性標誌。
- [\*] 包括跌級樓板上之混凝土填充層厚度。

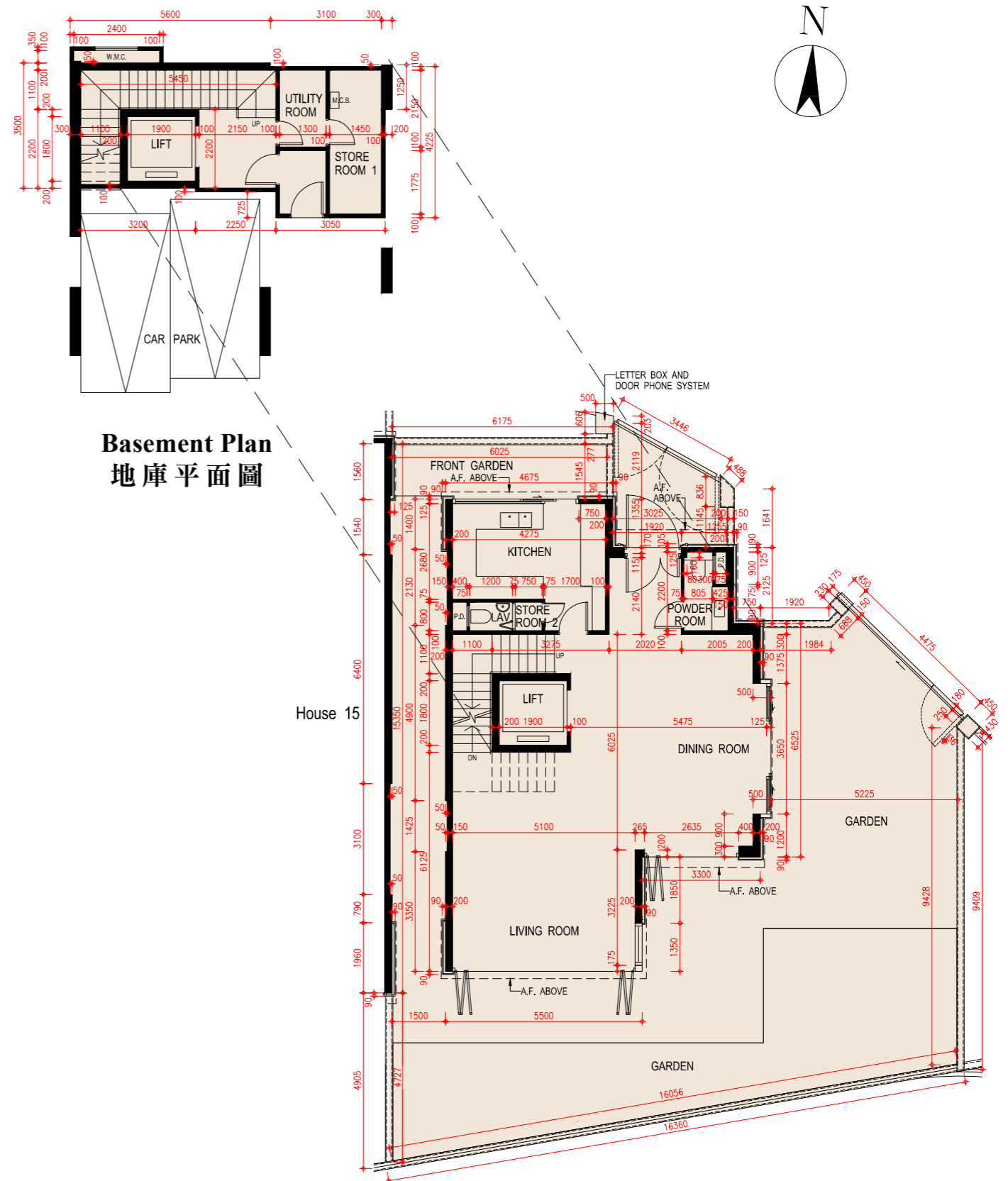

Basement Plan  
地庫平面圖

G/F Plan  
地下平面圖

Scale: 0M/米 5M/米  
比例: 1:5000

FLOOR PLANS OF RESIDENTIAL PROPERTIES IN THE DEVELOPMENT

發展項目的住宅物業的樓面平面圖

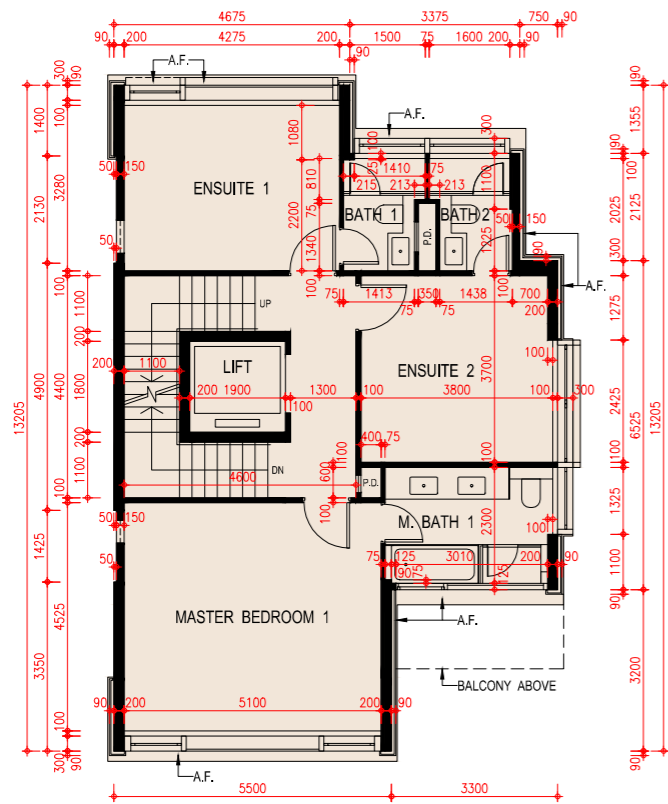

1/F Plan  
一樓平面圖

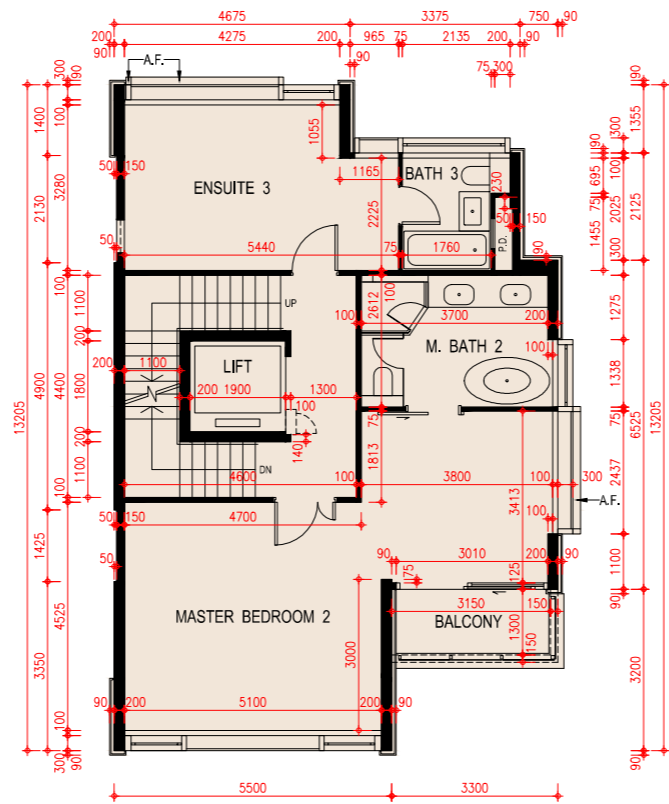

2/F Plan  
二樓平面圖

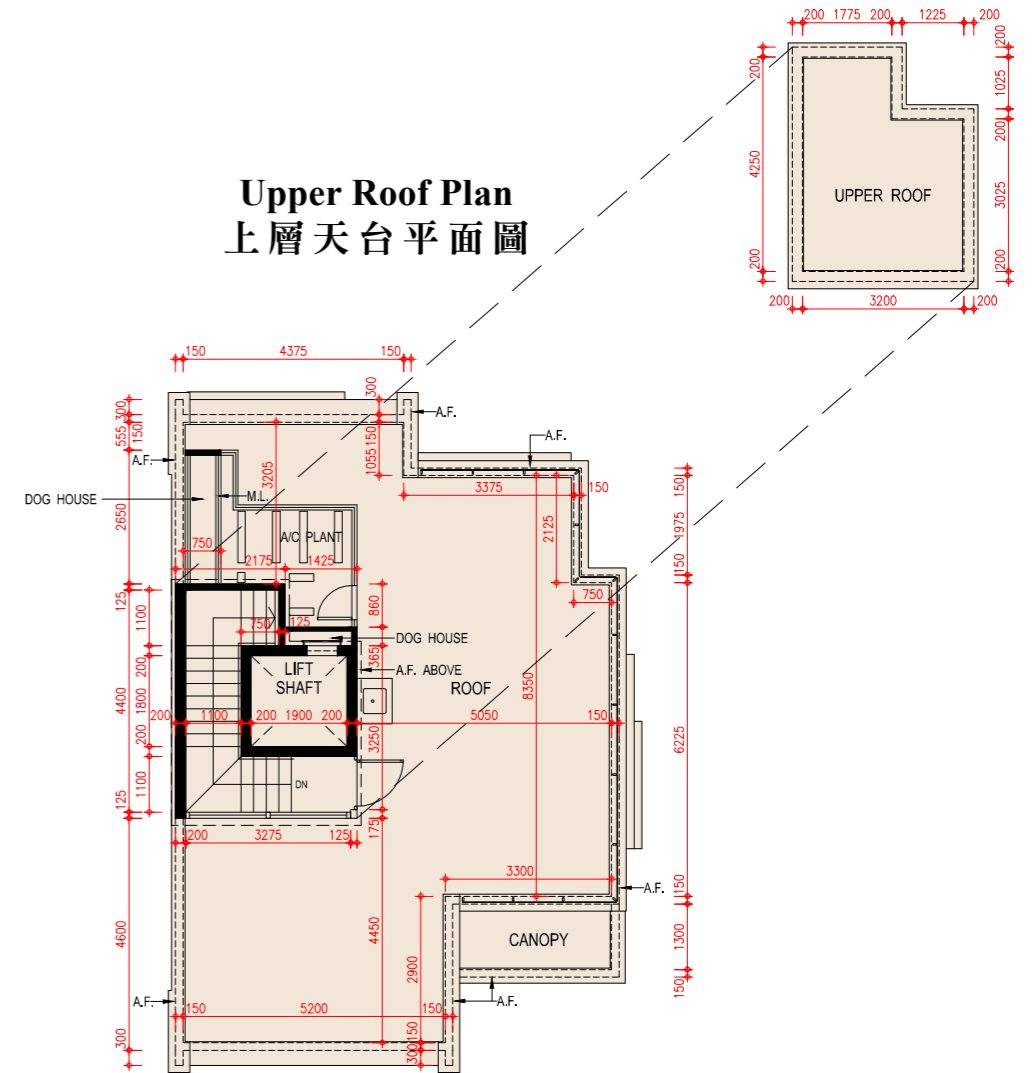

Upper Roof Plan  
上層天台平面圖

Scale: 0M/米 5M/米  
比例:

# FLOOR PLANS OF RESIDENTIAL PROPERTIES IN THE DEVELOPMENT

## 發展項目的住宅物業的樓面平面圖

### House 15 15號洋房

Floor 樓層	The thickness of the floor slabs (excluding plaster) of each House (mm) 每座洋房的樓板(不包括灰泥)的厚度(毫米)	The floor-to-floor height of each House (mm) 每座洋房的層與層之間的高度(毫米)
Basement 地庫	170, 200	4150, 4550, 4850*
G/F 地下	125, 150, 200	3900, 4200, 4500*, 4600*
1/F 1樓	125, 150, 200	3500, 3600
2/F 2樓	125, 150, 200	3500, 3550, 3900
Roof 天台	150	2350

The internal areas of the residential properties on the upper floors will generally be slightly larger than those on the lower floors because of the reducing thickness of the structural walls on the upper floors.

因住宅物業的較高樓層的結構牆的厚度遞減，較高樓層的內部面積，一般比較低樓層的內部面積稍大。

**Notes:**

- The dimensions of floor plans are all structural dimensions in millimeter.
- There may be architectural features and/or exposed pipes on external walls of the residential properties. For details, please refer to the latest approved building plans.
- Common pipes exposed and/or enclosed in cladding are located at/adjacent to flat roof and/or external wall of the residential properties. For details, please refer to the latest approved building plans.
- There are ceiling bulkheads and/or sunken slab at living/dining room, bedrooms, ensuites, study rooms, utility rooms, store rooms, corridors, bathrooms, powder rooms, lavatories and kitchen of some residential units for the air-conditioning system and/or mechanical and electrical services.
- Symbols of fittings and fitments shown in the floor plans, such as bathtubs, sink, water closets, shower, sink counter etc are architectural symbols extracted from the latest approved general building plans for general indication only.
- [\*] Inclusive of the thickness of mass concrete fill on sunken slab.

**備註：**

- 平面圖所列之尺寸數字為以毫米標示之建築尺寸。
- 住宅物業的外牆設有建築裝飾及/或外露喉管。詳細資料請參考最新批准之建築圖則。
- 住宅物業的平台及/或外牆設有外露及/或外牆裝飾板內藏之公用喉管。詳細資料請參考最新批准的建築圖則。
- 部份住宅單位的客/飯廳、睡房、套房、書房、工作間、儲物室、走廊、浴室、客廳洗手間、洗手間及廚房有假天花及/或有跌級樓板用以裝置冷氣系統及/或機電設備。
- 樓面平面圖上所顯示的形象裝置符號，例如浴缸、洗滌盆、坐廁、花灑、洗滌盆櫃乃摘自最新的經批准的建築圖則，並只作一般性標誌。
- [\*] 包括跌級樓板上之混凝土填充層厚度。

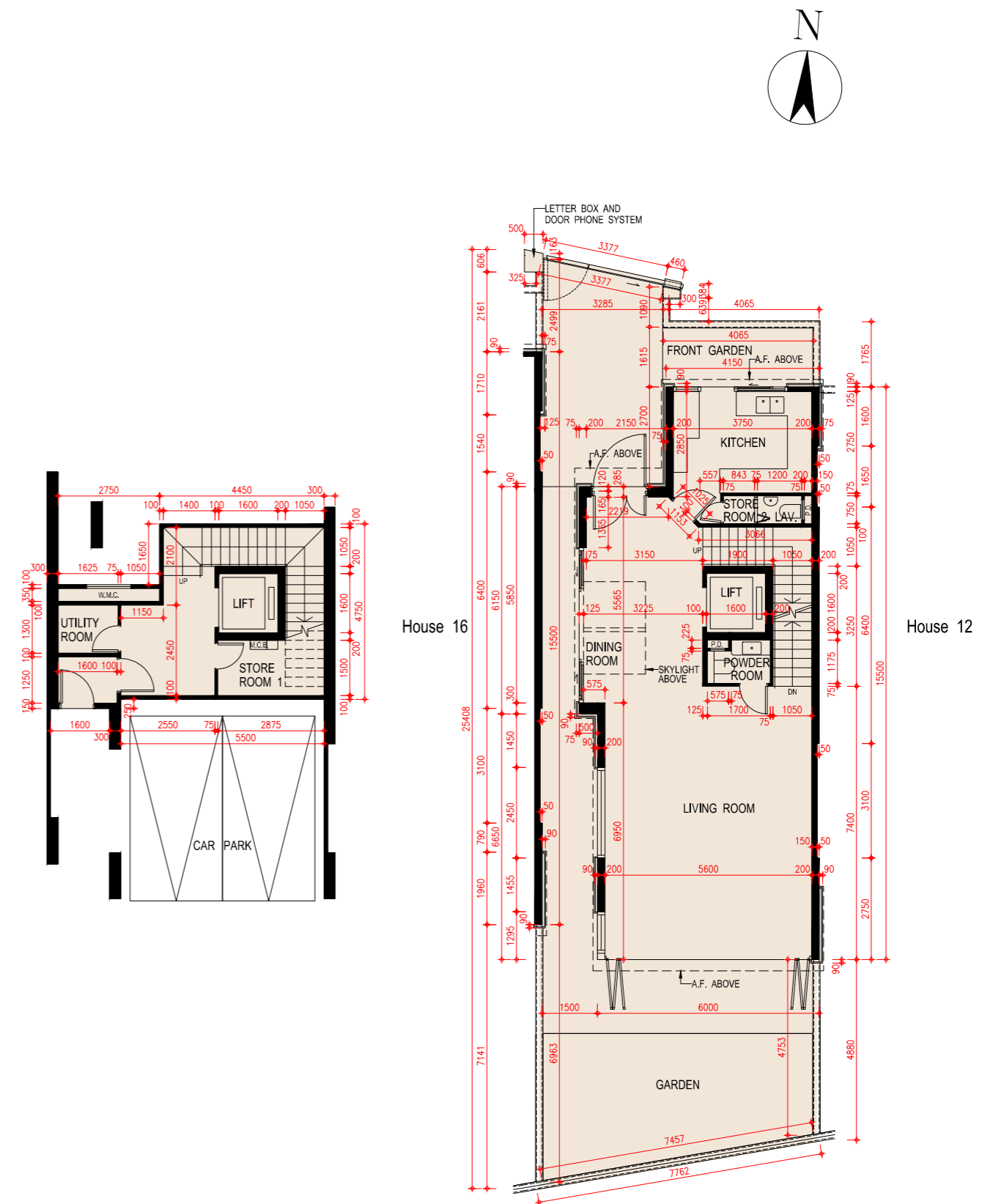

**Basement Plan**  
地庫平面圖

**G/F Plan**  
地下平面圖

Scale: 0M/米  
比例: 0 5M/米



FLOOR PLANS OF RESIDENTIAL PROPERTIES IN THE DEVELOPMENT  
 發展項目的住宅物業的樓面平面圖

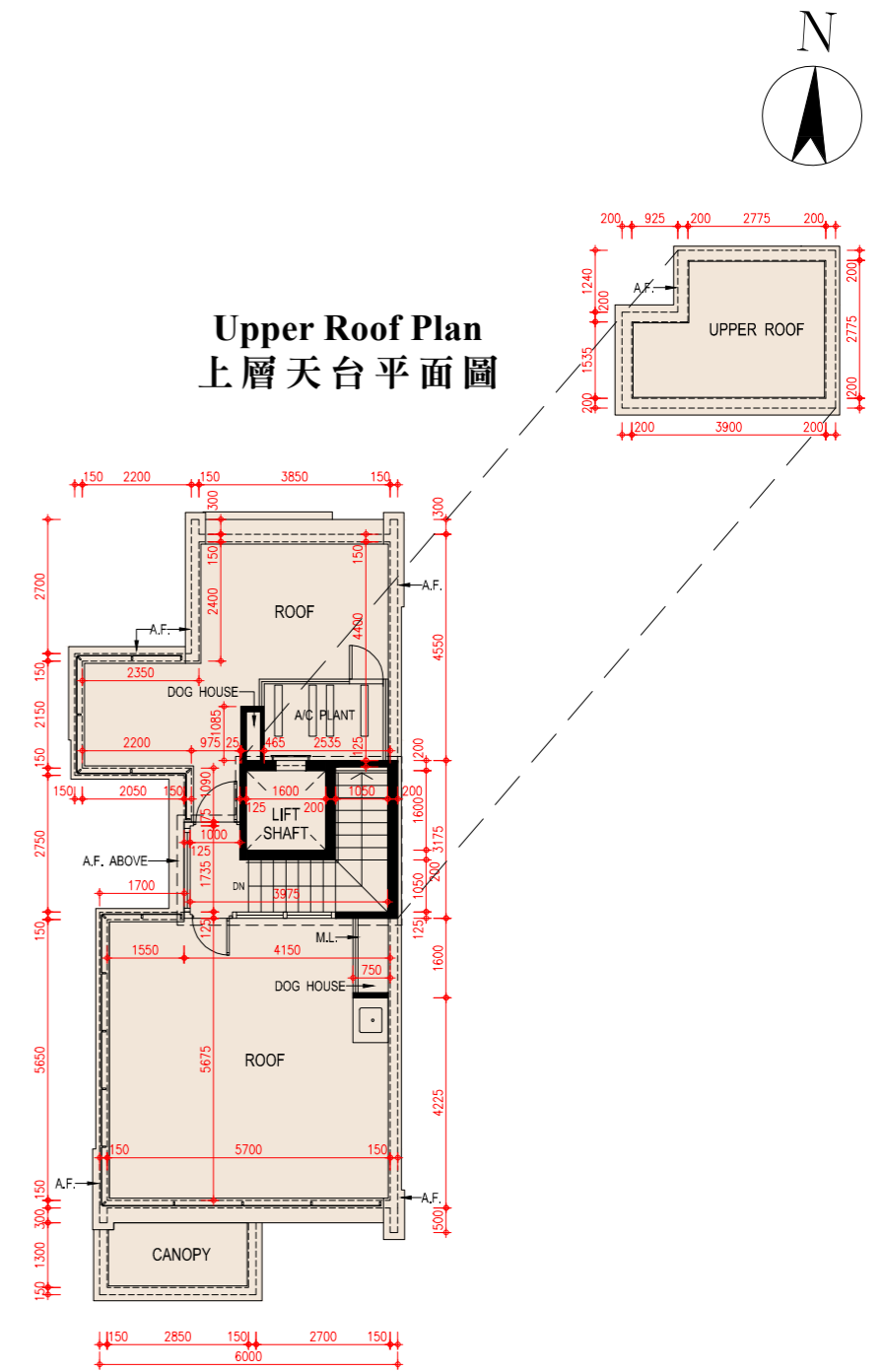
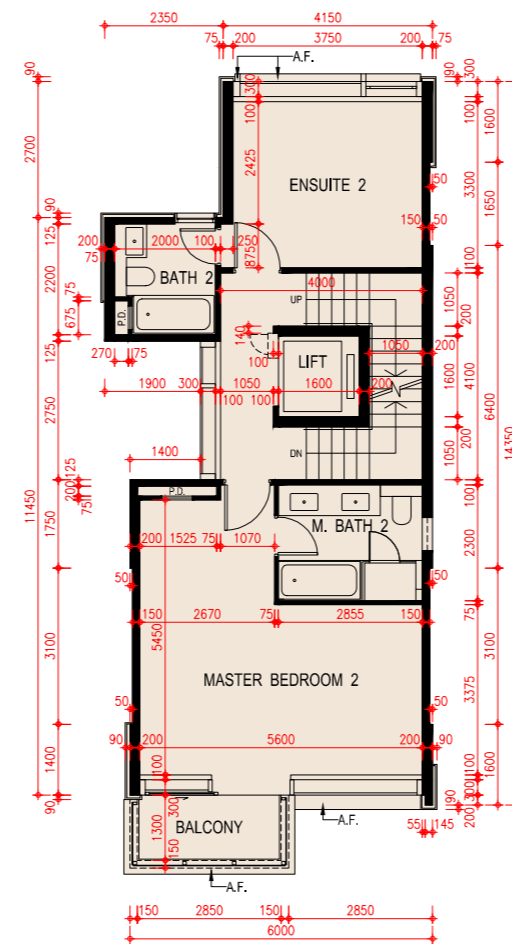
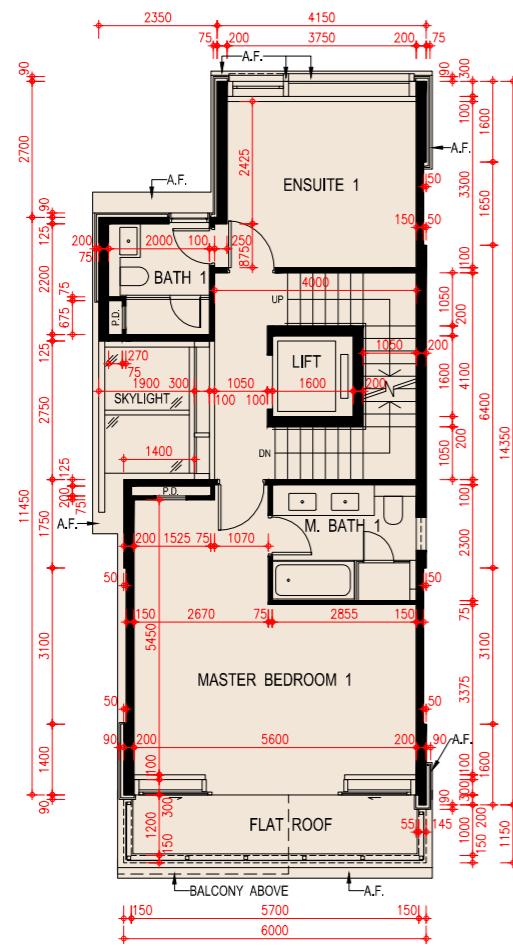

1/F Plan  
 一樓平面圖

2/F Plan  
 二樓平面圖

Roof Plan  
 天台平面圖

Scale: 0M/米 5M/米  
 比例:

# FLOOR PLANS OF RESIDENTIAL PROPERTIES IN THE DEVELOPMENT

## 發展項目的住宅物業的樓面平面圖

### House 16 16號洋房

Floor 樓層	The thickness of the floor slabs (excluding plaster) of each House (mm) 每座洋房的樓板(不包括灰泥)的厚度(毫米)	The floor-to-floor height of each House (mm) 每座洋房的層與層之間的高度(毫米)
Basement 地庫	170, 200	4150, 4550, 4850*
G/F 地下	125, 150, 200	3900, 4200, 4500*, 4600*
1/F 1樓	125, 150, 200	3500, 3600
2/F 2樓	125, 150, 200	3500, 3550, 3900*
Roof 天台	150	2350

The internal areas of the residential properties on the upper floors will generally be slightly larger than those on the lower floors because of the reducing thickness of the structural walls on the upper floors.

因住宅物業的較高樓層的結構牆的厚度遞減，較高樓層的內部面積，一般比較低樓層的內部面積稍大。

#### Notes:

- The dimensions of floor plans are all structural dimensions in millimeter.
- There may be architectural features and/or exposed pipes on external walls of the residential properties. For details, please refer to the latest approved building plans.
- Common pipes exposed and/or enclosed in cladding are located at/adjacent to flat roof and/or external wall of the residential properties. For details, please refer to the latest approved building plans.
- There are ceiling bulkheads and/or sunken slab at living/dining room, bedrooms, ensuites, study rooms, utility rooms, store rooms, corridors, bathrooms, powder rooms, lavatories and kitchen of some residential units for the air-conditioning system and/or mechanical and electrical services.
- Symbols of fittings and fitments shown in the floor plans, such as bathtubs, sink, water closets, shower, sink counter etc are architectural symbols extracted from the latest approved general building plans for general indication only.
- [\*] Inclusive of the thickness of mass concrete fill on sunken slab.

#### 備註：

- 平面圖所列之尺寸數字為以毫米標示之建築尺寸。
- 住宅物業的外牆設有建築裝飾及/或外露喉管。詳細資料請參考最新批准之建築圖則。
- 住宅物業的平台及/或外牆設有外露及/或外牆裝飾板內藏之公用喉管。詳細資料請參考最新批准的建築圖則。
- 部份住宅單位的客/飯廳、睡房、套房、書房、工作間、儲物室、走廊、浴室、客廳洗手間、洗手間及廚房有假天花及/或有跌級樓板用以裝置冷氣系統及/或機電設備。
- 樓面平面圖上所顯示的形象裝置符號，例如浴缸、洗滌盆、坐廁、花灑、洗滌盆櫃乃摘自最新的經批准的建築圖則，並只作一般性標誌。
- [\*] 包括跌級樓板上之混凝土填充層厚度。

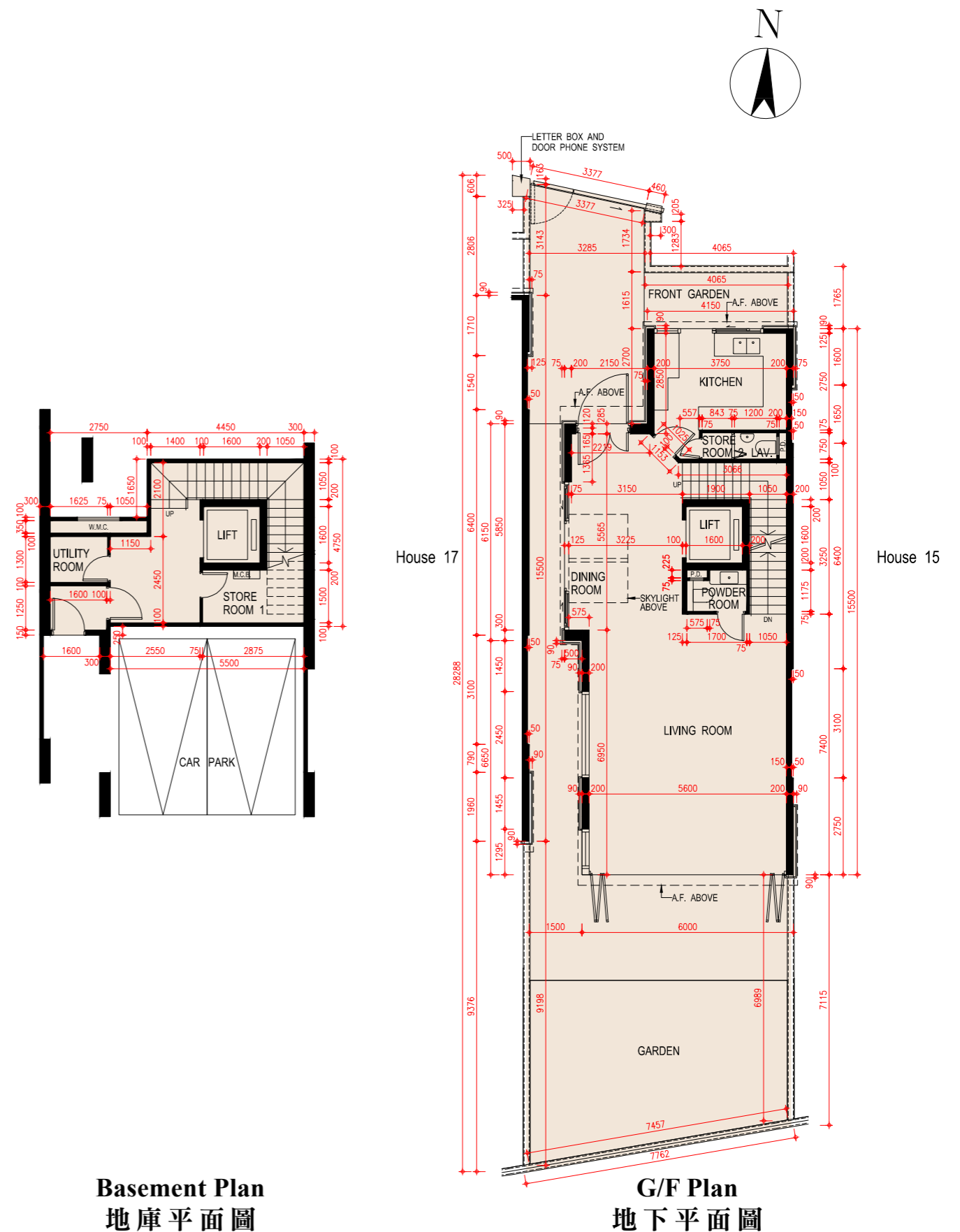

Basement Plan  
地庫平面圖

G/F Plan  
地下平面圖

Scale: 0M/米 5M/米  
比例: 0 5

FLOOR PLANS OF RESIDENTIAL PROPERTIES IN THE DEVELOPMENT

發展項目的住宅物業的樓面平面圖

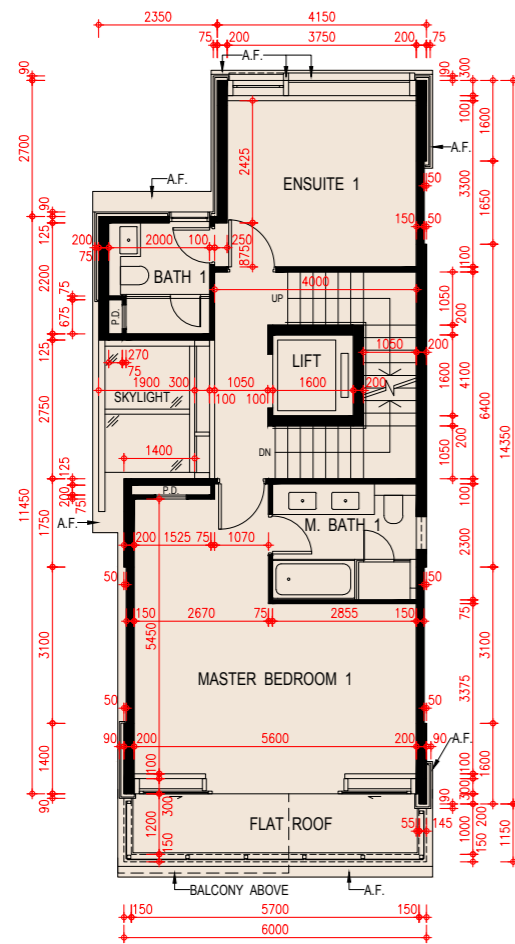

1/F Plan  
一樓平面圖

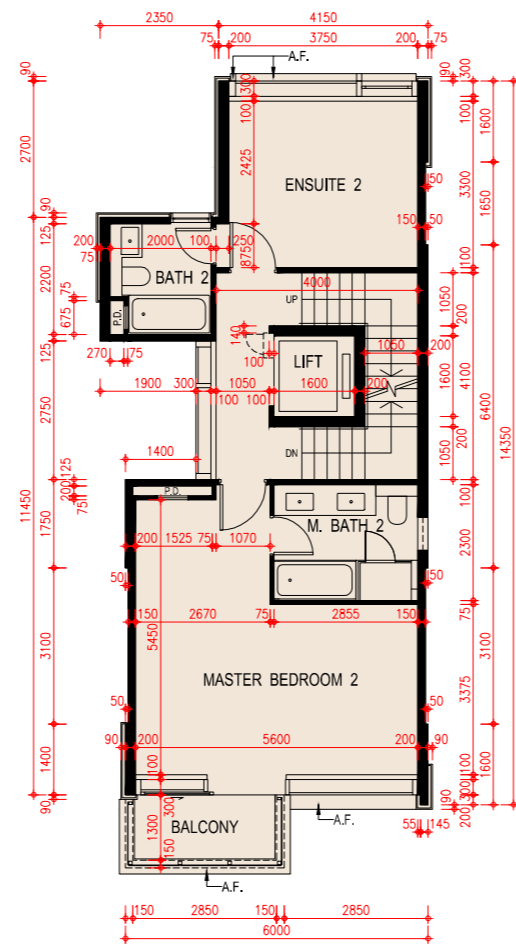

2/F Plan  
二樓平面圖

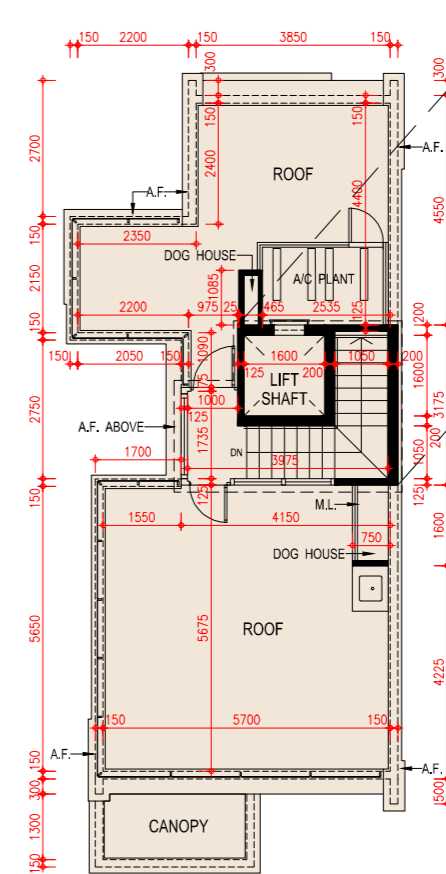

Roof Plan  
天台平面圖

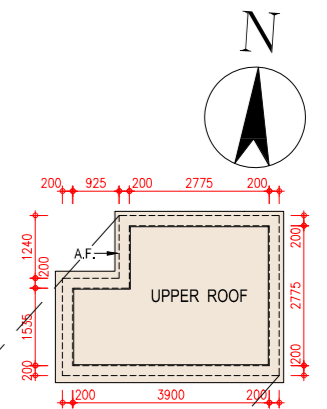

Scale: 0M/米 5M/米  
比例: 1:5000

# FLOOR PLANS OF RESIDENTIAL PROPERTIES IN THE DEVELOPMENT

## 發展項目的住宅物業的樓面平面圖

### House 17 17號洋房

Floor 樓層	The thickness of the floor slabs (excluding plaster) of each House (mm) 每座洋房的樓板(不包括灰泥)的厚度(毫米)	The floor-to-floor height of each House (mm) 每座洋房的層與層之間的高度(毫米)
Basement 地庫	170, 200	4150, 4550, 4850*
G/F 地下	125, 150, 200	3900, 4200, 4500*, 4600*
1/F 1樓	125, 150, 200	3500, 3600
2/F 2樓	125, 150, 200	3500, 3550, 3900
Roof 天台	150	2350

The internal areas of the residential properties on the upper floors will generally be slightly larger than those on the lower floors because of the reducing thickness of the structural walls on the upper floors.

因住宅物業的較高樓層的結構牆的厚度遞減，較高樓層的內部面積，一般比較低樓層的內部面積稍大。

#### Notes:

- The dimensions of floor plans are all structural dimensions in millimeter.
- There may be architectural features and/or exposed pipes on external walls of the residential properties. For details, please refer to the latest approved building plans.
- Common pipes exposed and/or enclosed in cladding are located at/adjacent to flat roof and/or external wall of the residential properties. For details, please refer to the latest approved building plans.
- There are ceiling bulkheads and/or sunken slab at living/dining room, bedrooms, ensuites, study rooms, utility rooms, store rooms, corridors, bathrooms, powder rooms, lavatories and kitchen of some residential units for the air-conditioning system and/or mechanical and electrical services.
- Symbols of fittings and fitments shown in the floor plans, such as bathtubs, sink, water closets, shower, sink counter etc are architectural symbols extracted from the latest approved general building plans for general indication only.
- [\*] Inclusive of the thickness of mass concrete fill on sunken slab.

#### 備註：

- 平面圖所列之尺寸數字為以毫米標示之建築尺寸。
- 住宅物業的外牆設有建築裝飾及/或外露喉管。詳細資料請參考最新批准之建築圖則。
- 住宅物業的平台及/或外牆設有外露及/或外牆裝飾板內藏之公用喉管。詳細資料請參考最新批准的建築圖則。
- 部份住宅單位的客/飯廳、睡房、套房、書房、工作間、儲物室、走廊、浴室、客廳洗手間、洗手間及廚房有假天花及/或有跌級樓板用以裝置冷氣系統及/或機電設備。
- 樓面平面圖上所顯示的形象裝置符號，例如浴缸、洗滌盆、坐廁、花灑、洗滌盆櫃乃摘自最新的經批准的建築圖則，並只作一般性標誌。
- [\*] 包括跌級樓板上之混凝土填充層厚度。

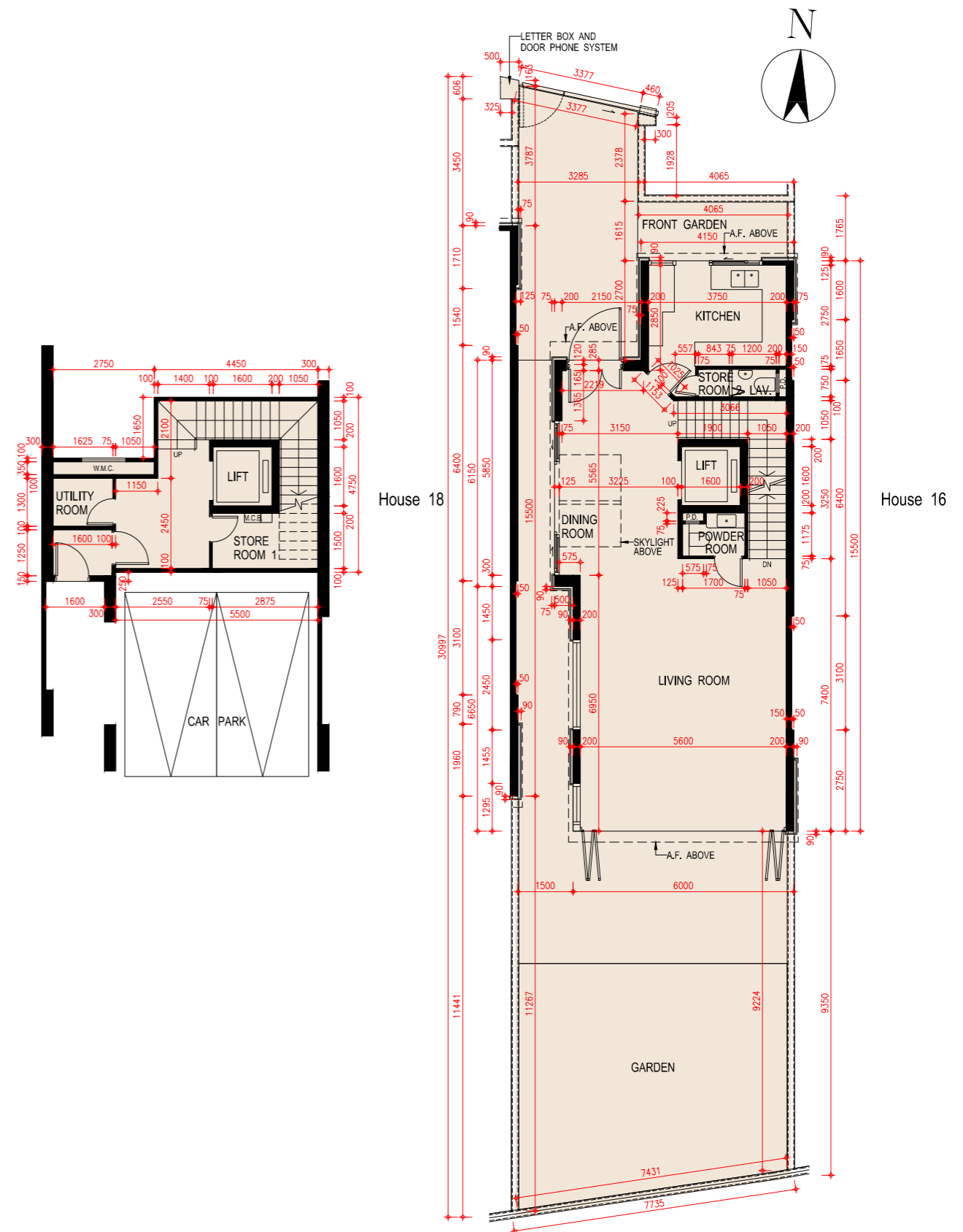

Basement Plan  
地庫平面圖

G/F Plan  
地下平面圖

Scale: 0M/米  
比例: 1:500



FLOOR PLANS OF RESIDENTIAL PROPERTIES IN THE DEVELOPMENT  
發展項目的住宅物業的樓面平面圖

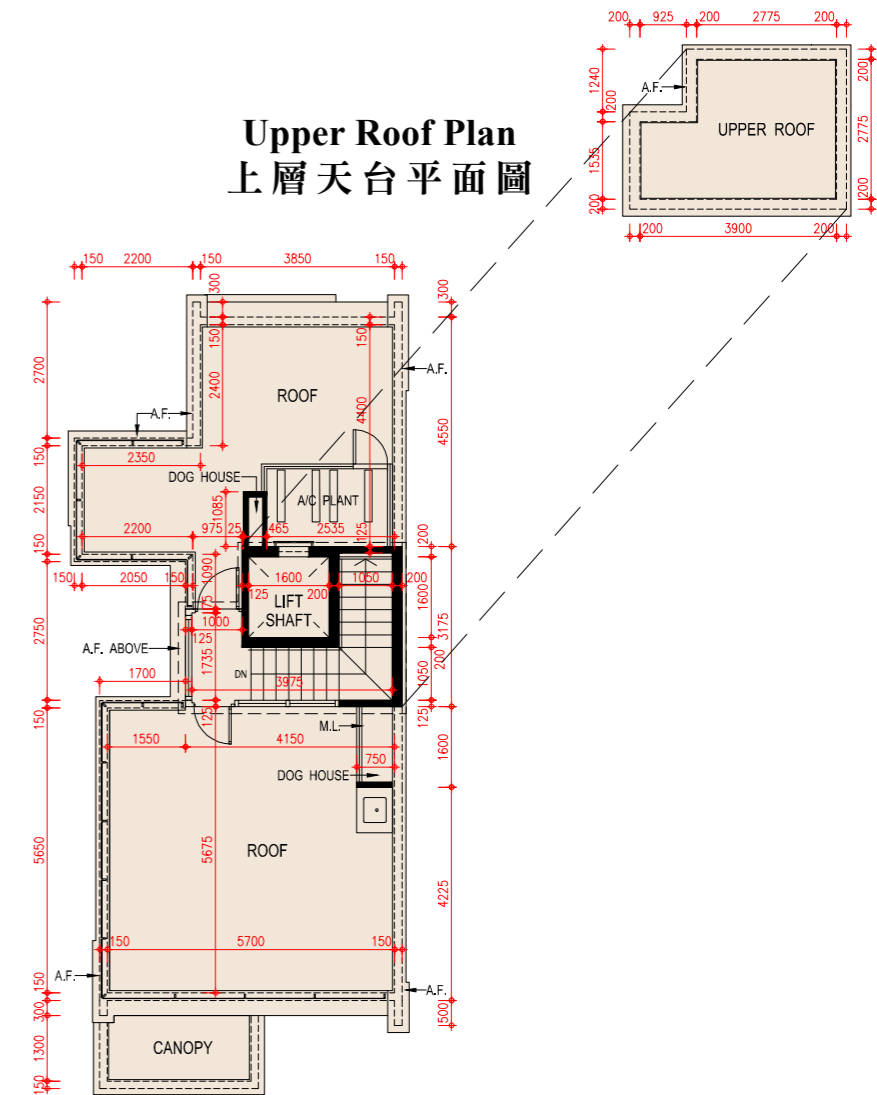
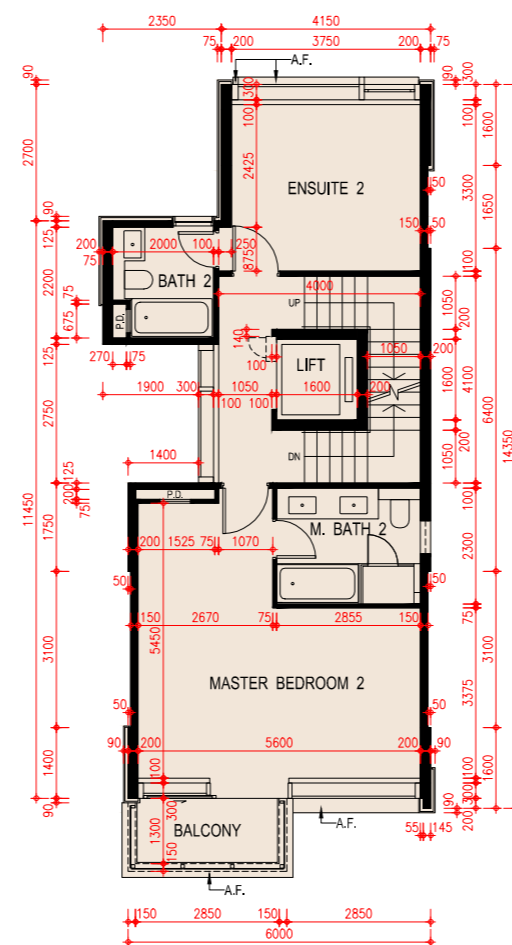
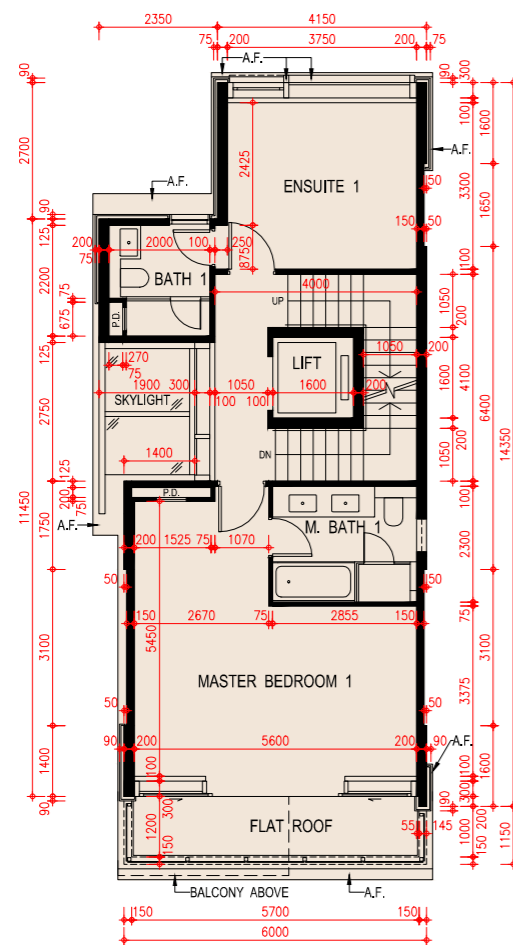
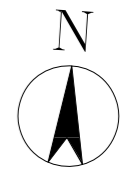

1/F Plan  
一樓平面圖

2/F Plan  
二樓平面圖

Roof Plan  
天台平面圖

Scale: 0M/米 5M/米  
比例:

# FLOOR PLANS OF RESIDENTIAL PROPERTIES IN THE DEVELOPMENT

## 發展項目的住宅物業的樓面平面圖

### House 18 18號洋房

Floor 樓層	The thickness of the floor slabs (excluding plaster) of each House (mm) 每座洋房的樓板(不包括灰泥)的厚度(毫米)	The floor-to-floor height of each House (mm) 每座洋房的層與層之間的高度(毫米)
Basement 地庫	170, 200	4150, 4550, 4850*
G/F 地下	125, 150, 200	3900, 4200, 4500*, 4600*
1/F 1樓	125, 150, 200	3500, 3600
2/F 2樓	125, 150, 200	3500, 3550, 3900
Roof 天台	150	2350

The internal areas of the residential properties on the upper floors will generally be slightly larger than those on the lower floors because of the reducing thickness of the structural walls on the upper floors.

因住宅物業的較高樓層的結構牆的厚度遞減，較高樓層的內部面積，一般比較低樓層的內部面積稍大。

#### Notes:

- The dimensions of floor plans are all structural dimensions in millimeter.
- There may be architectural features and/or exposed pipes on external walls of the residential properties. For details, please refer to the latest approved building plans.
- Common pipes exposed and/or enclosed in cladding are located at/adjacent to flat roof and/or external wall of the residential properties. For details, please refer to the latest approved building plans.
- There are ceiling bulkheads and/or sunken slab at living/dining room, bedrooms, ensuites, study rooms, utility rooms, store rooms, corridors, bathrooms, powder rooms, lavatories and kitchen of some residential units for the air-conditioning system and/or mechanical and electrical services.
- Symbols of fittings and fitments shown in the floor plans, such as bathtubs, sink, water closets, shower, sink counter etc are architectural symbols extracted from the latest approved general building plans for general indication only.
- [\*] Inclusive of the thickness of mass concrete fill on sunken slab.

#### 備註：

- 平面圖所列之尺寸數字為以毫米標示之建築尺寸。
- 住宅物業的外牆設有建築裝飾及/或外露喉管。詳細資料請參考最新批准之建築圖則。
- 住宅物業的平台及/或外牆設有外露及/或外牆裝飾板內藏之公用喉管。詳細資料請參考最新批准的建築圖則。
- 部份住宅單位的客/飯廳、睡房、套房、書房、工作間、儲物室、走廊、浴室、客廳洗手間、洗手間及廚房有假天花及/或有跌級樓板用以裝置冷氣系統及/或機電設備。
- 樓面平面圖上所顯示的形象裝置符號，例如浴缸、洗滌盆、坐廁、花灑、洗滌盆櫃乃摘自最新的經批准的建築圖則，並只作一般性標誌。
- [\*] 包括跌級樓板上之混凝土填充層厚度。

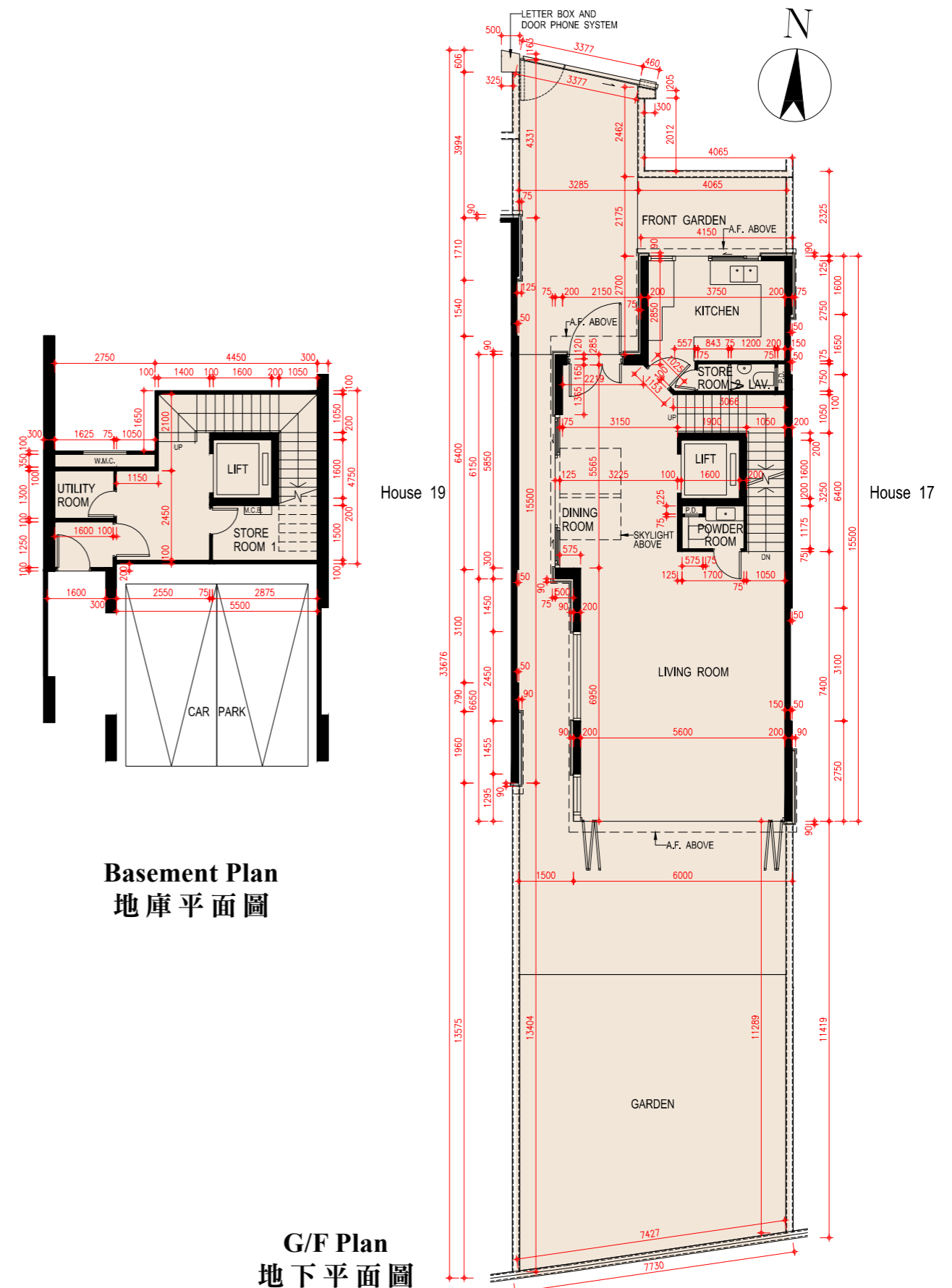

FLOOR PLANS OF RESIDENTIAL PROPERTIES IN THE DEVELOPMENT  
發展項目的住宅物業的樓面平面圖

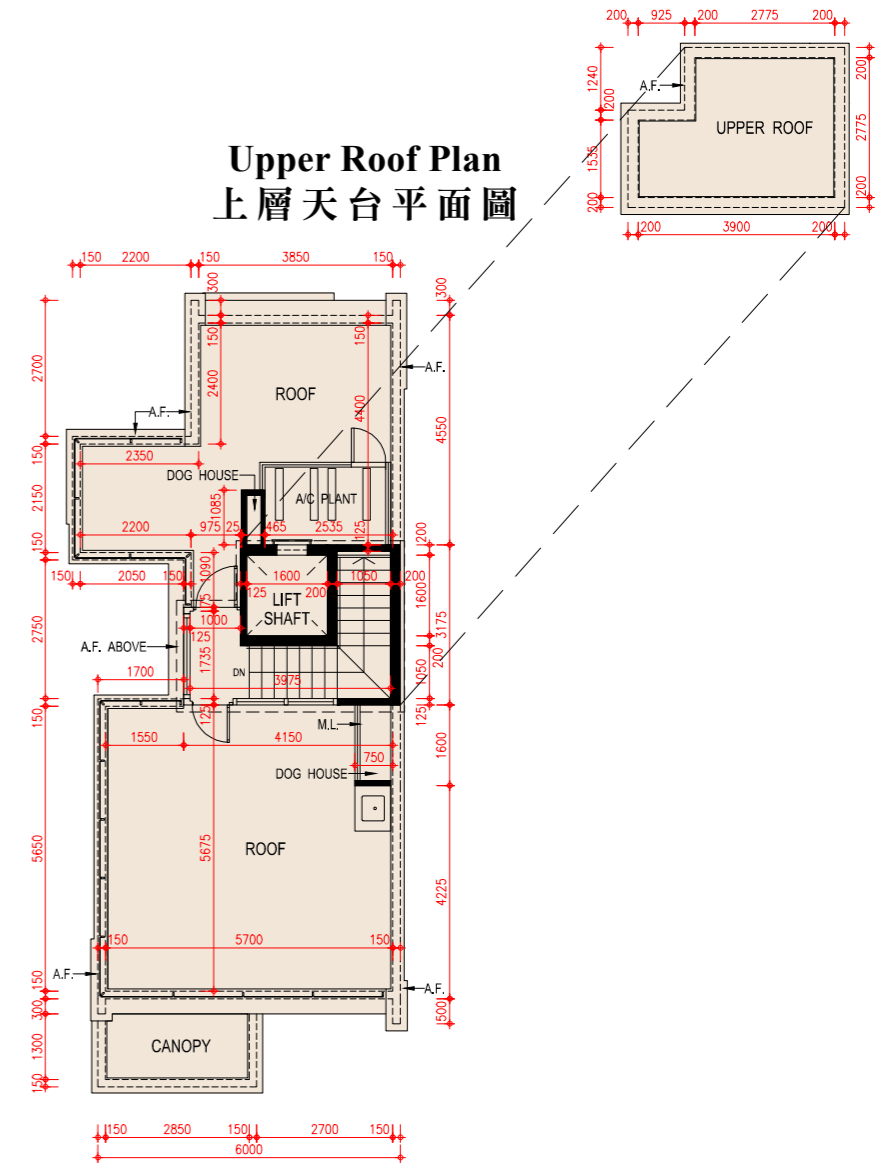
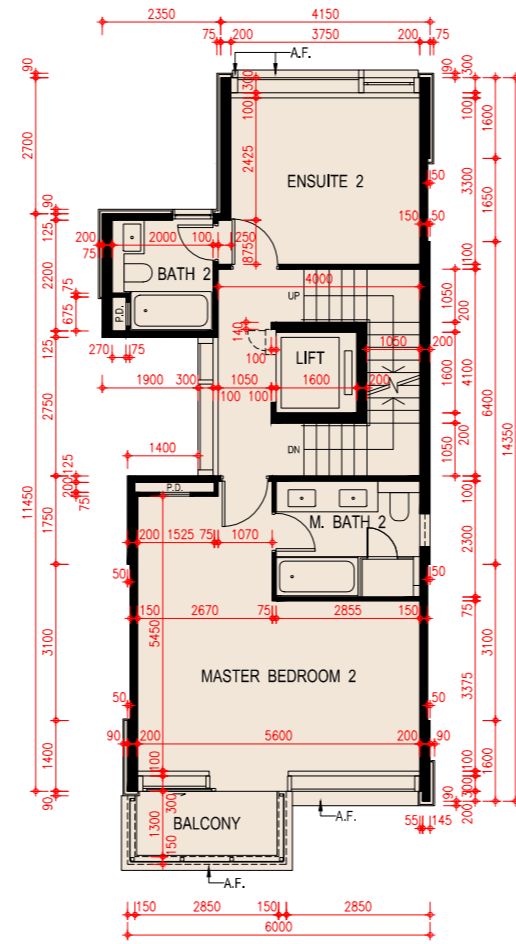
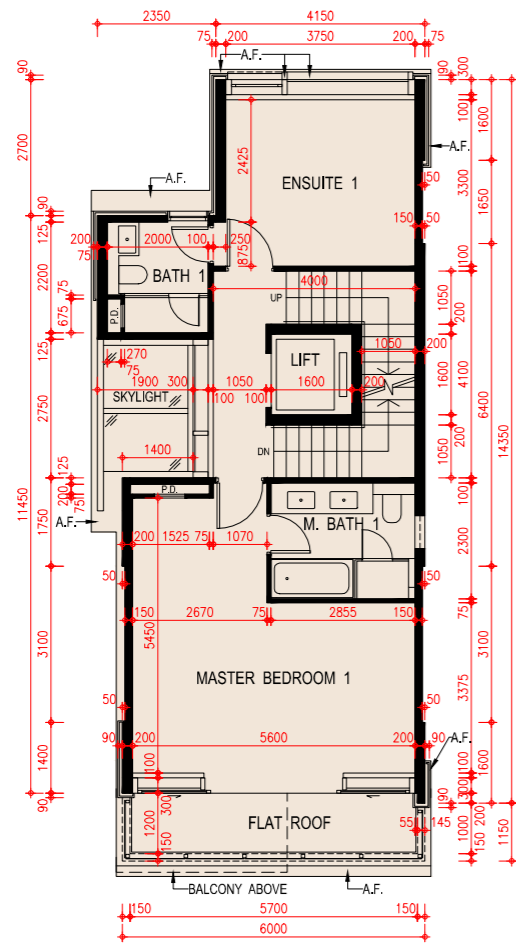
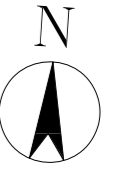

1/F Plan  
一樓平面圖

2/F Plan  
二樓平面圖

Roof Plan  
天台平面圖

Scale: 0M/米 5M/米  
比例:

# FLOOR PLANS OF RESIDENTIAL PROPERTIES IN THE DEVELOPMENT

## 發展項目的住宅物業的樓面平面圖

### House 19 19號洋房

Floor 樓層	The thickness of the floor slabs (excluding plaster) of each House (mm) 每座洋房的樓板(不包括灰泥)的厚度(毫米)	The floor-to-floor height of each House (mm) 每座洋房的層與層之間的高度(毫米)
Basement 地庫	170, 200	4150, 4550, 4850*
G/F 地下	125, 150, 200	3900, 4200, 4500*, 4600*
1/F 1樓	125, 150, 200	3500, 3600, 3900
2/F 2樓	125, 150, 200	3500, 3550
Roof 天台	150	2350

The internal areas of the residential properties on the upper floors will generally be slightly larger than those on the lower floors because of the reducing thickness of the structural walls on the upper floors.

因住宅物業的較高樓層的結構牆的厚度遞減，較高樓層的內部面積，一般比較低樓層的內部面積稍大。

**Notes:**

- The dimensions of floor plans are all structural dimensions in millimeter.
- There may be architectural features and/or exposed pipes on external walls of the residential properties. For details, please refer to the latest approved building plans.
- Common pipes exposed and/or enclosed in cladding are located at/adjacent to flat roof and/or external wall of the residential properties. For details, please refer to the latest approved building plans.
- There are ceiling bulkheads and/or sunken slab at living/dining room, bedrooms, ensuites, study rooms, utility rooms, store rooms, corridors, bathrooms, powder rooms, lavatories and kitchen of some residential units for the air-conditioning system and/or mechanical and electrical services.
- Symbols of fittings and fitments shown in the floor plans, such as bathtubs, sink, water closets, shower, sink counter etc are architectural symbols extracted from the latest approved general building plans for general indication only.
- [\*] Inclusive of the thickness of mass concrete fill on sunken slab.

**備註：**

- 平面圖所列之尺寸數字為以毫米標示之建築尺寸。
- 住宅物業的外牆設有建築裝飾及/或外露喉管。詳細資料請參考最新批准之建築圖則。
- 住宅物業的平台及/或外牆設有外露及/或外牆裝飾板內藏之公用喉管。詳細資料請參考最新批准的建築圖則。
- 部份住宅單位的客/飯廳、睡房、套房、書房、工作間、儲物室、走廊、浴室、客廳洗手間、洗手間及廚房有假天花及/或有跌級樓板用以裝置冷氣系統及/或機電設備。
- 樓面平面圖上所顯示的形象裝置符號，例如浴缸、洗滌盆、坐廁、花灑、洗滌盆櫃乃摘自最新的經批准的建築圖則，並只作一般性標誌。
- [\*] 包括跌級樓板上之混凝土填充層厚度。

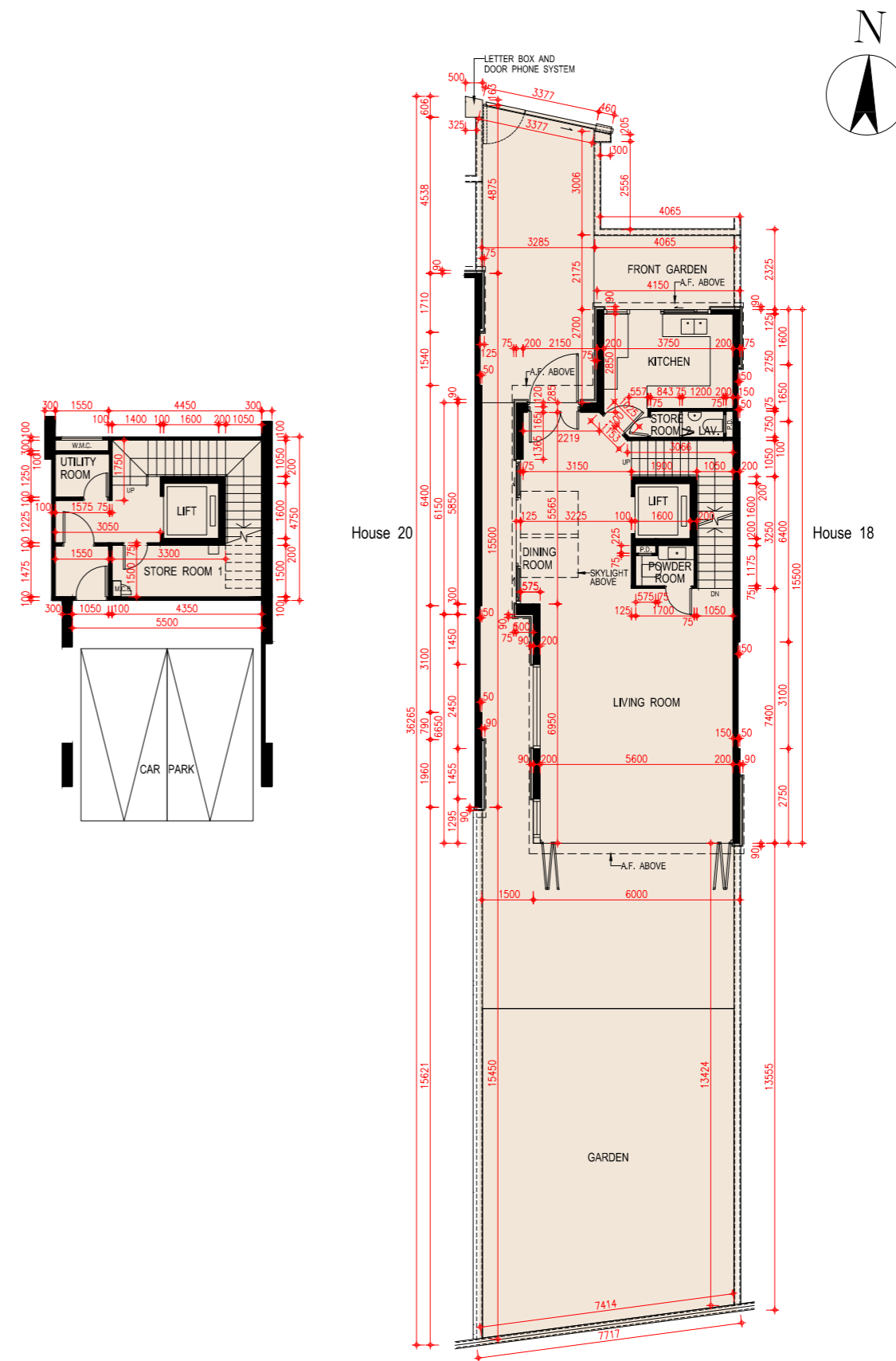

**Basement Plan  
地庫平面圖**

**G/F Plan  
地下平面圖**

Scale: 0M/米 5M/米  
比例: 1:500



FLOOR PLANS OF RESIDENTIAL PROPERTIES IN THE DEVELOPMENT  
發展項目的住宅物業的樓面平面圖

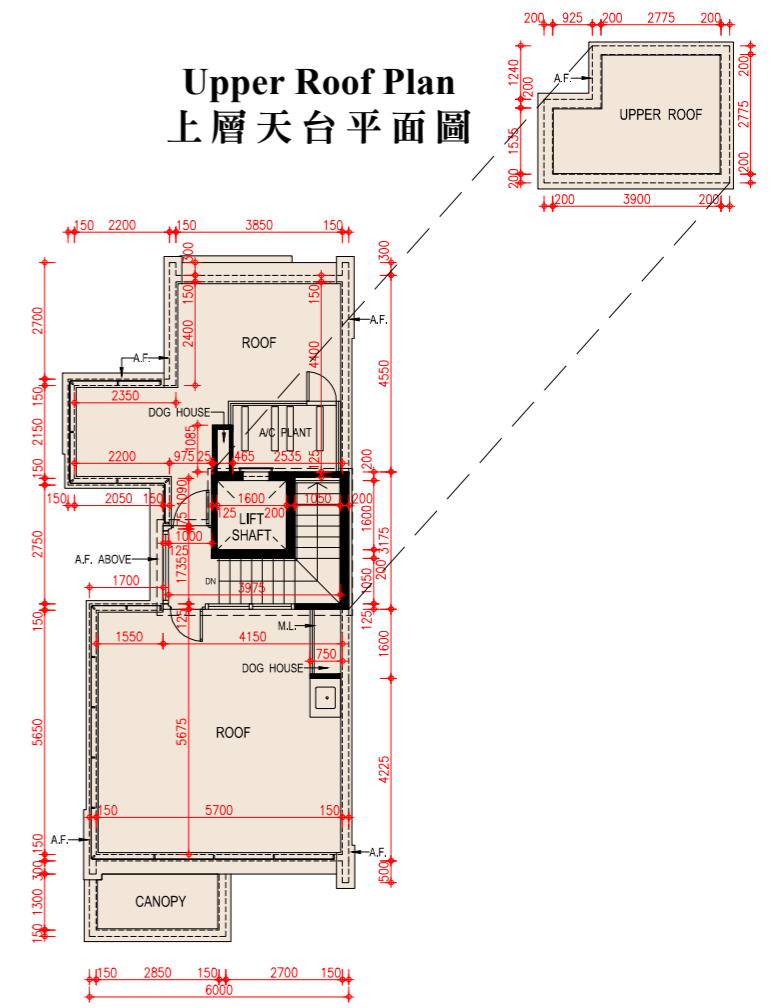
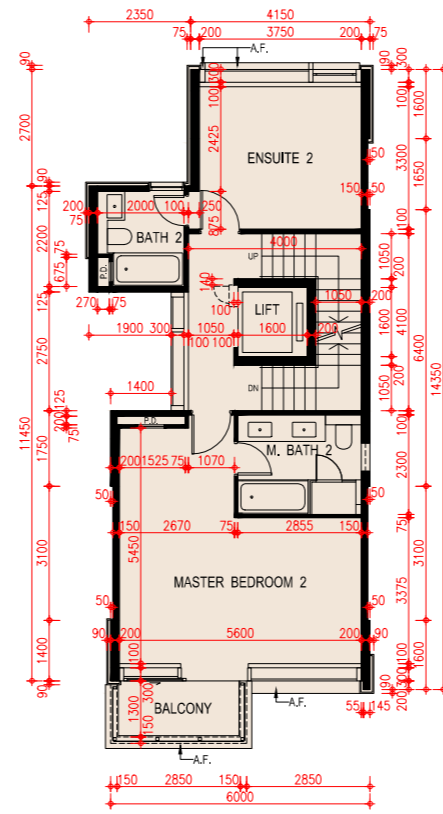
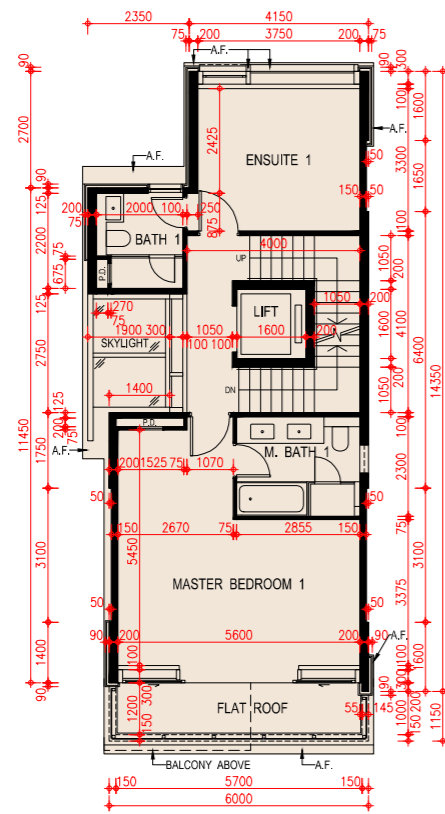
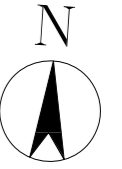

Scale: 0M/米 5M/米  
比例:

# FLOOR PLANS OF RESIDENTIAL PROPERTIES IN THE DEVELOPMENT

## 發展項目的住宅物業的樓面平面圖

### House 20 20號洋房

Floor 樓層	The thickness of the floor slabs (excluding plaster) of each House (mm) 每座洋房的樓板(不包括灰泥)的厚度(毫米)	The floor-to-floor height of each House (mm) 每座洋房的層與層之間的高度(毫米)
Basement 地庫	170, 200	4150, 4550, 4750*, 4850*
G/F 地下	125, 150, 200	3900, 4200, 4500*, 4600*
1/F 1樓	125, 150, 200	3500, 3600
2/F 2樓	125, 150, 200	3500, 3550, 3900
Roof 天台	150	2350

The internal areas of the residential properties on the upper floors will generally be slightly larger than those on the lower floors because of the reducing thickness of the structural walls on the upper floors.

因住宅物業的較高樓層的結構牆的厚度遞減，較高樓層的內部面積，一般比較低樓層的內部面積稍大。

#### Notes:

- The dimensions of floor plans are all structural dimensions in millimeter.
- There may be architectural features and/or exposed pipes on external walls of the residential properties. For details, please refer to the latest approved building plans.
- Common pipes exposed and/or enclosed in cladding are located at/adjacent to flat roof and/or external wall of the residential properties. For details, please refer to the latest approved building plans.
- There are ceiling bulkheads and/or sunken slab at living/dining room, bedrooms, ensuites, study rooms, utility rooms, store rooms, corridors, bathrooms, powder rooms, lavatories and kitchen of some residential units for the air-conditioning system and/or mechanical and electrical services.
- Symbols of fittings and fitments shown in the floor plans, such as bathtubs, sink, water closets, shower, sink counter etc are architectural symbols extracted from the latest approved general building plans for general indication only.
- [\*] Inclusive of the thickness of mass concrete fill on sunken slab.
- House 20 has been altered by way of minor works or exempted works under the Buildings Ordinance after the completion of the Development. The latest condition of which is shown on the relevant floor plans. The alterations are as follows:  
A. Adjustments have been made to the door of Lavatory at G/F.  
B. Adjustments have been made to the wash basin of Lavatory at G/F.  
C. Glass partitions have been added to the of Master Bathroom at 2/F.

#### 備註:

- 平面圖所列之尺寸數字為以毫米標示之建築尺寸。
- 住宅物業的外牆設有建築裝飾及/或外露喉管。詳細資料請參考最新批准之建築圖則。
- 住宅物業的平台及/或外牆設有外露及/或外牆裝飾板內藏之公用喉管。詳細資料請參考最新批准的建築圖則。
- 部份住宅單位的客/飯廳、睡房、套房、書房、工作間、儲物室、走廊、浴室、客廳洗手間、洗手間及廚房有假天花及/或有跌級樓板用以裝置冷氣系統及/或機電設備。
- 樓面平面圖上所顯示的形象裝置符號，例如浴缸、洗滌盆、坐廁、花灑、洗滌盆櫃乃摘自最新的經批准的建築圖則，並只作一般性標誌。
- [\*] 包括跌級樓板上之混凝土填充層厚度。
- 20號洋房在發展項目落成後進行小型工程或獲《建築物條例》豁免的工程而有所改動。現狀請參考有關平面圖，該等改動如下：  
A. 地下洗手間的門已被改動。  
B. 地下洗手間的洗手盆已被改動。  
C. 2樓主人浴室已加建玻璃間隔。

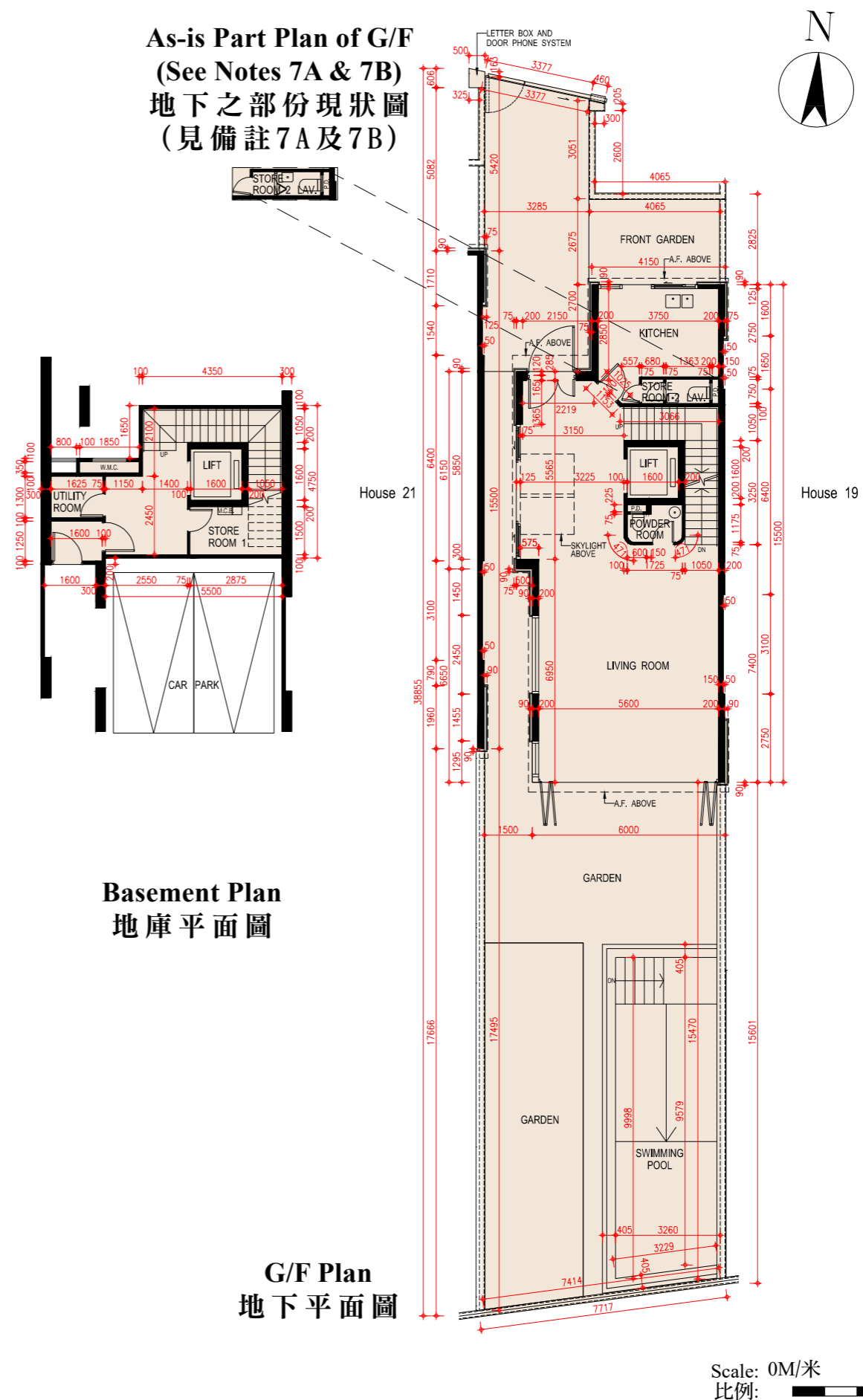

FLOOR PLANS OF RESIDENTIAL PROPERTIES IN THE DEVELOPMENT  
發展項目的住宅物業的樓面平面圖

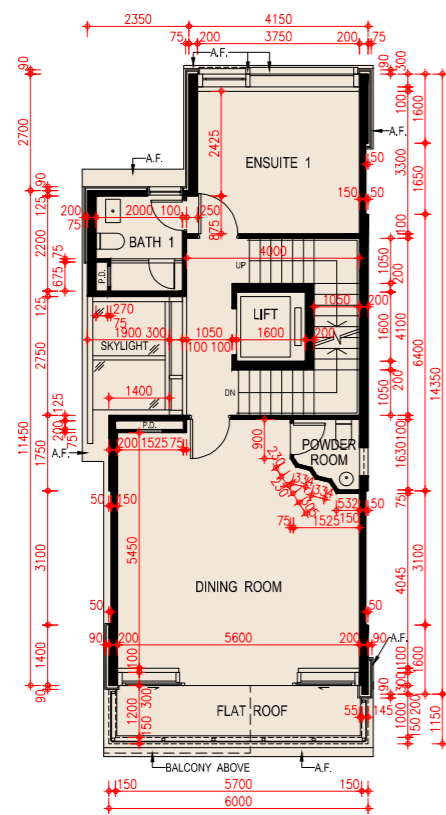
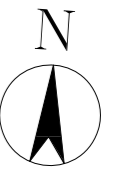

1/F Plan  
一樓平面圖

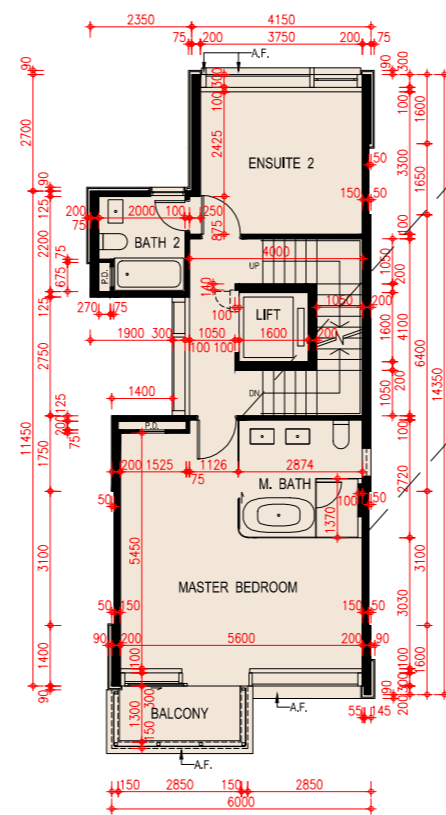

2/F Plan  
二樓平面圖

As-is Part Plan of 2/F  
(See Notes 7C)  
二樓之部份現狀圖  
(見備註7C)

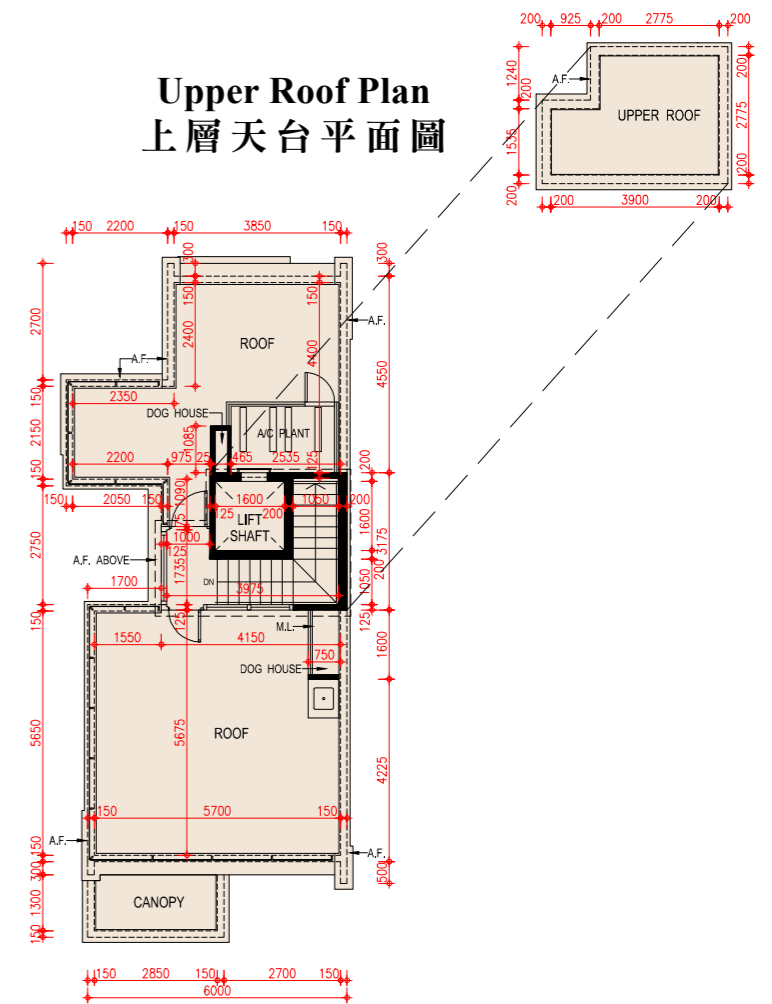
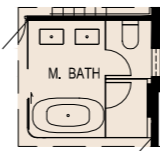

Roof Plan  
天台平面圖

Scale: 0M/米 5M/米  
比例: 5M/米

# FLOOR PLANS OF RESIDENTIAL PROPERTIES IN THE DEVELOPMENT

## 發展項目的住宅物業的樓面平面圖

### House 21 21號洋房

Floor 樓層	The thickness of the floor slabs (excluding plaster) of each House (mm) 每座洋房的樓板(不包括灰泥)的厚度(毫米)	The floor-to-floor height of each House (mm) 每座洋房的層與層之間的高度(毫米)
Basement 地庫	170, 200	4150, 4550, 4750*, 4850*
G/F 地下	125, 150, 200	3900, 4200, 4500*, 4600*
1/F 1樓	125, 150, 200	3500, 3600
2/F 2樓	125, 150, 200	3500, 3550, 3900
Roof 天台	150	2350

The internal areas of the residential properties on the upper floors will generally be slightly larger than those on the lower floors because of the reducing thickness of the structural walls on the upper floors.

因住宅物業的較高樓層的結構牆的厚度遞減，較高樓層的內部面積，一般比較低樓層的內部面積稍大。

#### Notes:

- The dimensions of floor plans are all structural dimensions in millimeter.
- There may be architectural features and/or exposed pipes on external walls of the residential properties. For details, please refer to the latest approved building plans.
- Common pipes exposed and/or enclosed in cladding are located at/adjacent to flat roof and/or external wall of the residential properties. For details, please refer to the latest approved building plans.
- There are ceiling bulkheads and/or sunken slab at living/dining room, bedrooms, ensuites, study rooms, utility rooms, store rooms, corridors, bathrooms, powder rooms, lavatories and kitchen of some residential units for the air-conditioning system and/or mechanical and electrical services.
- Symbols of fittings and fitments shown in the floor plans, such as bathtubs, sink, water closets, shower, sink counter etc are architectural symbols extracted from the latest approved general building plans for general indication only.
- [\*] Inclusive of the thickness of mass concrete fill on sunken slab.

#### 備註：

- 平面圖所列之尺寸數字為以毫米標示之建築尺寸。
- 住宅物業的外牆設有建築裝飾及/或外露喉管。詳細資料請參考最新批准之建築圖則。
- 住宅物業的平台及/或外牆設有外露及/或外牆裝飾板內藏之公用喉管。詳細資料請參考最新批准的建築圖則。
- 部份住宅單位的客/飯廳、睡房、套房、書房、工作間、儲物室、走廊、浴室、客廳洗手間、洗手間及廚房有假天花及/或有跌級樓板用以裝置冷氣系統及/或機電設備。
- 樓面平面圖上所顯示的形象裝置符號，例如浴缸、洗滌盆、坐廁、花灑、洗滌盆櫃乃摘自最新的經批准的建築圖則，並只作一般性標誌。
- [\*] 包括跌級樓板上之混凝土填充層厚度。

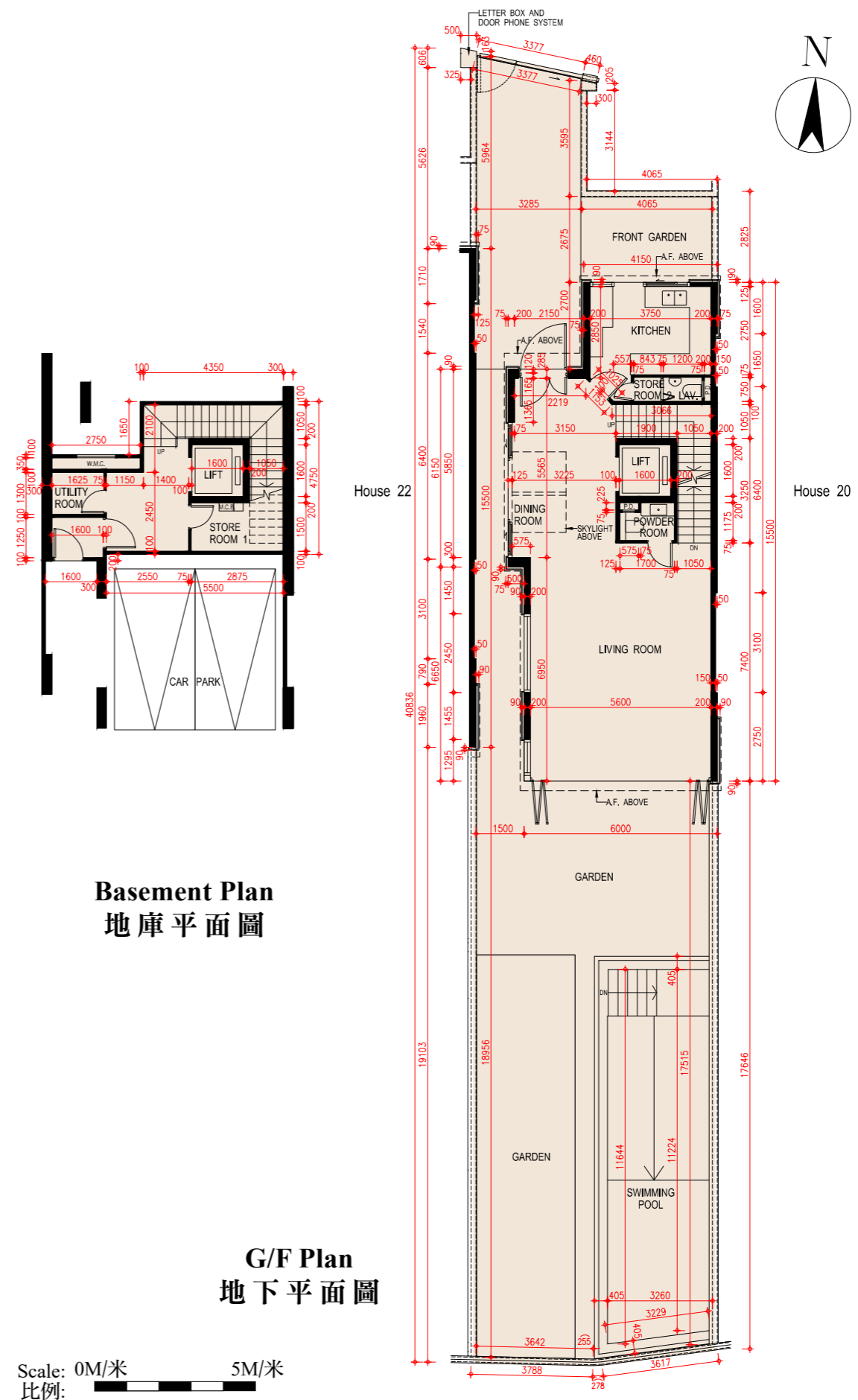



**FLOOR PLANS OF RESIDENTIAL PROPERTIES IN THE DEVELOPMENT**  
**發展項目的住宅物業的樓面平面圖**

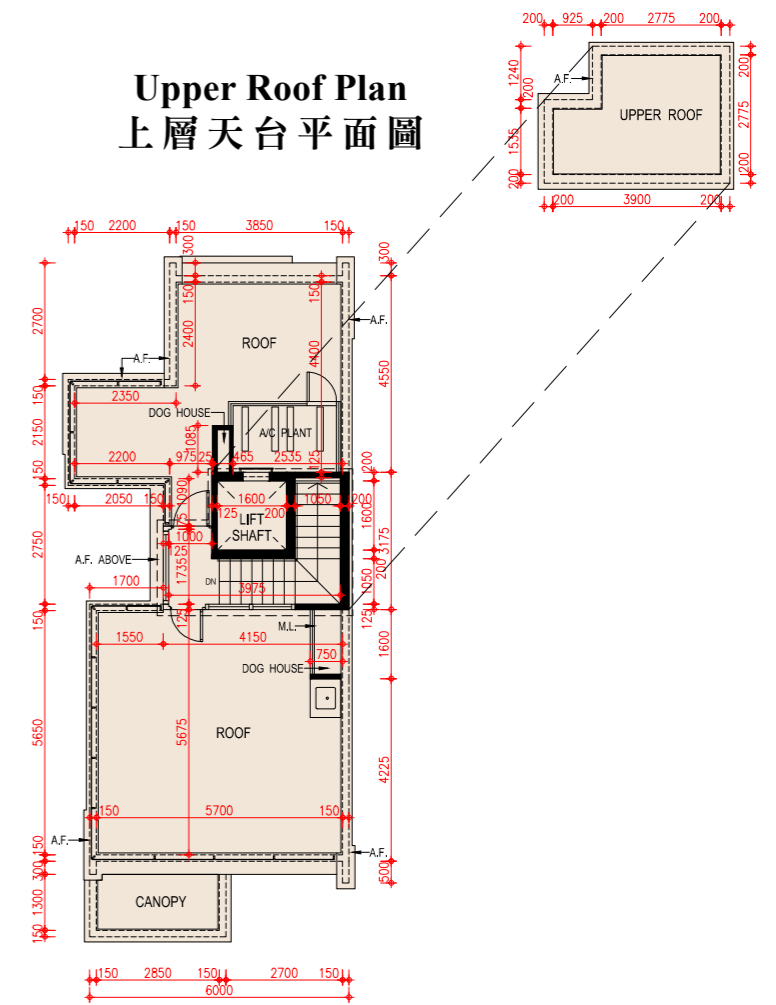
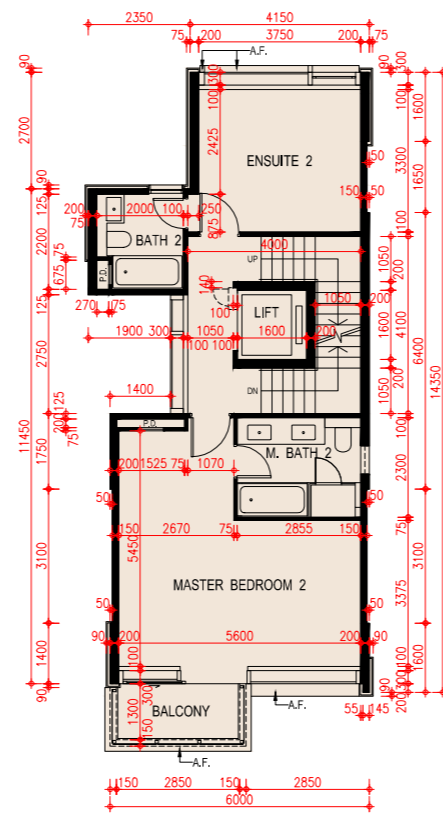
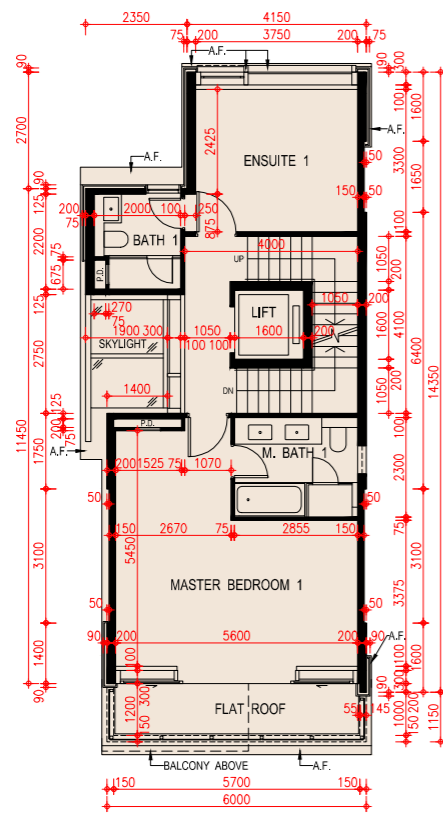
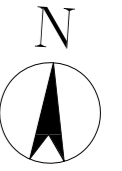

1/F Plan  
一樓平面圖

2/F Plan  
二樓平面圖

Roof Plan  
天台平面圖

Scale: 0M/米 5M/米  
 比例:

# FLOOR PLANS OF RESIDENTIAL PROPERTIES IN THE DEVELOPMENT

## 發展項目的住宅物業的樓面平面圖

### House 22 22號洋房

Floor 樓層	The thickness of the floor slabs (excluding plaster) of each House (mm) 每座洋房的樓板(不包括灰泥)的厚度(毫米)	The floor-to-floor height of each House (mm) 每座洋房的層與層之間的高度(毫米)
Basement 地庫	170, 200	4150, 4550, 4750*, 4850*
G/F 地下	125, 150, 200	3900, 4200, 4500*, 4600*
1/F 1樓	125, 150, 200	3500, 3600
2/F 2樓	125, 150, 200	3500, 3550, 3900
Roof 天台	150	2350

The internal areas of the residential properties on the upper floors will generally be slightly larger than those on the lower floors because of the reducing thickness of the structural walls on the upper floors.

因住宅物業的較高樓層的結構牆的厚度遞減，較高樓層的內部面積，一般比較低樓層的內部面積稍大。

#### Notes:

- The dimensions of floor plans are all structural dimensions in millimeter.
- There may be architectural features and/or exposed pipes on external walls of the residential properties. For details, please refer to the latest approved building plans.
- Common pipes exposed and/or enclosed in cladding are located at/adjacent to flat roof and/or external wall of the residential properties. For details, please refer to the latest approved building plans.
- There are ceiling bulkheads and/or sunken slab at living/dining room, bedrooms, ensuites, study rooms, utility rooms, store rooms, corridors, bathrooms, powder rooms, lavatories and kitchen of some residential units for the air-conditioning system and/or mechanical and electrical services.
- Symbols of fittings and fitments shown in the floor plans, such as bathtubs, sink, water closets, shower, sink counter etc are architectural symbols extracted from the latest approved general building plans for general indication only.
- [\*] Inclusive of the thickness of mass concrete fill on sunken slab.

#### 備註：

- 平面圖所列之尺寸數字為以毫米標示之建築尺寸。
- 住宅物業的外牆設有建築裝飾及/或外露喉管。詳細資料請參考最新批准之建築圖則。
- 住宅物業的平台及/或外牆設有外露及/或外牆裝飾板內藏之公用喉管。詳細資料請參考最新批准的建築圖則。
- 部份住宅單位的客/飯廳、睡房、套房、書房、工作間、儲物室、走廊、浴室、客廳洗手間、洗手間及廚房有假天花及/或有跌級樓板用以裝置冷氣系統及/或機電設備。
- 樓面平面圖上所顯示的形象裝置符號，例如浴缸、洗滌盆、坐廁、花灑、洗滌盆櫃乃摘自最新的經批准的建築圖則，並只作一般性標誌。
- [\*] 包括跌級樓板上之混凝土填充層厚度。

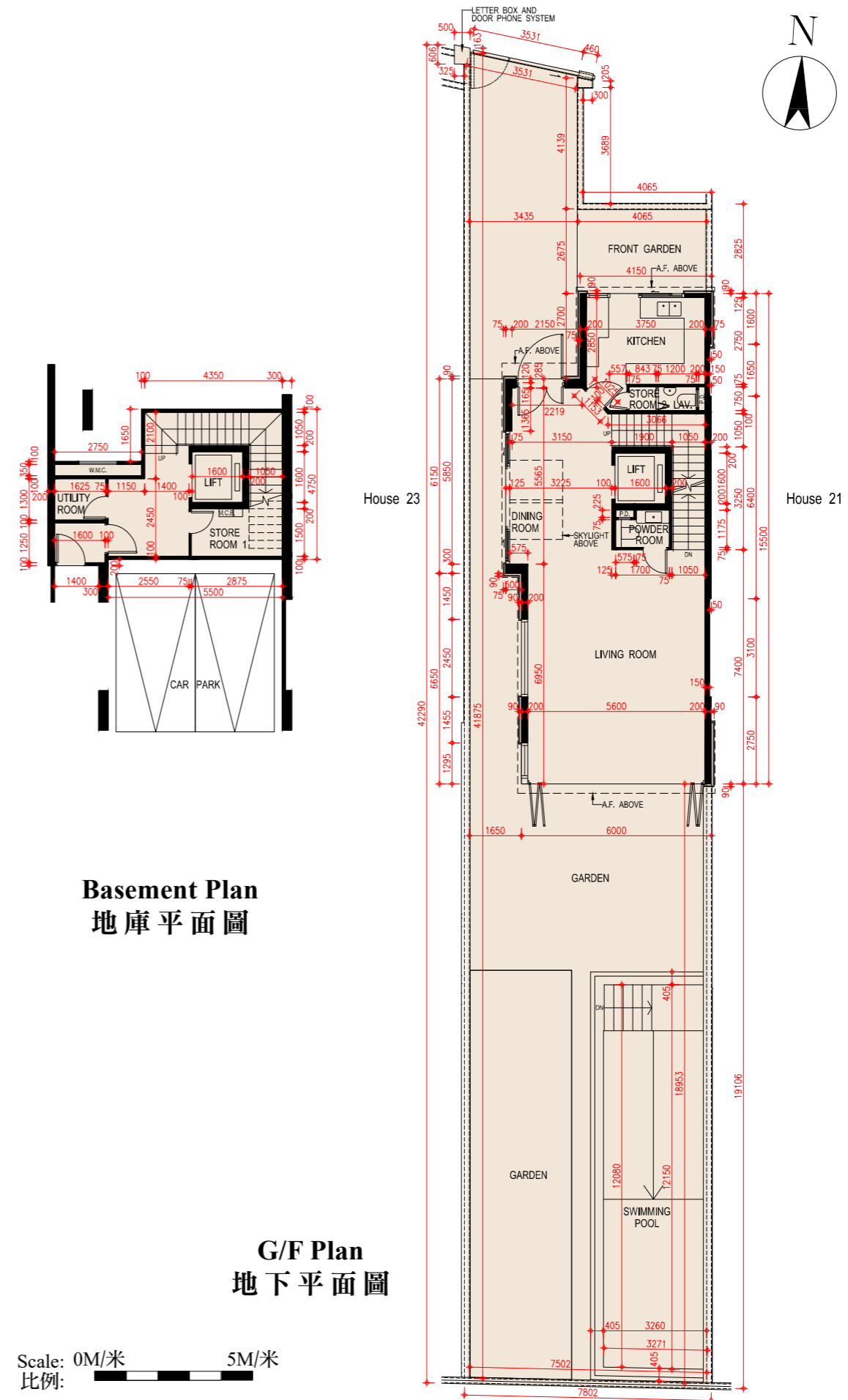

FLOOR PLANS OF RESIDENTIAL PROPERTIES IN THE DEVELOPMENT  
發展項目的住宅物業的樓面平面圖

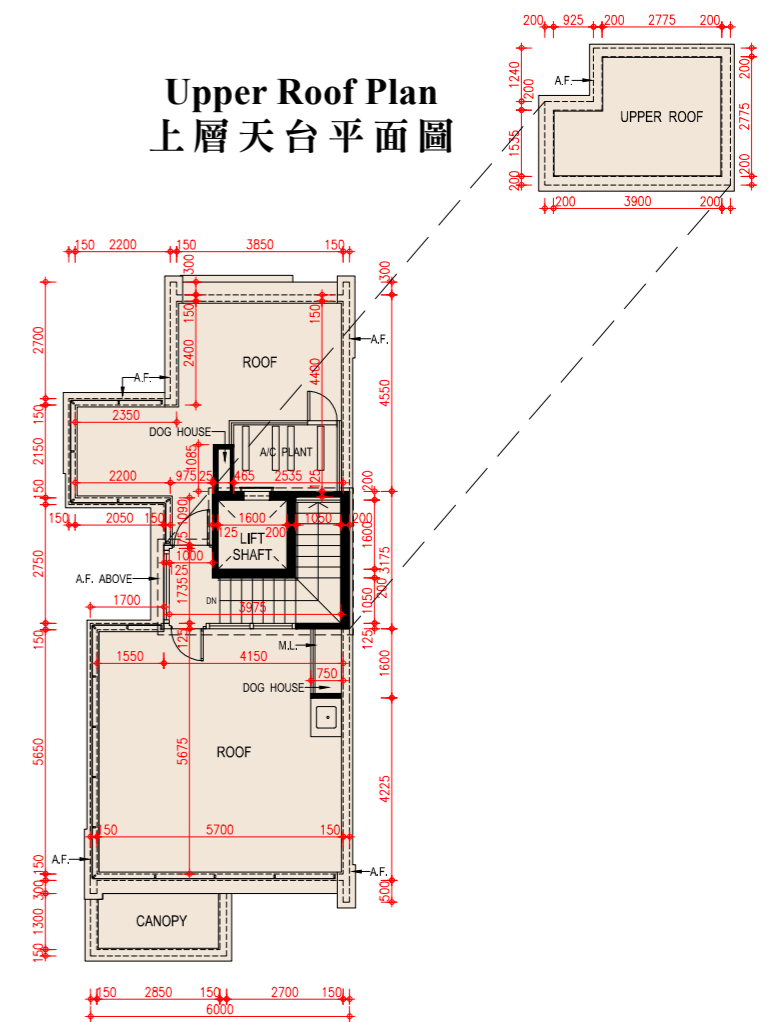
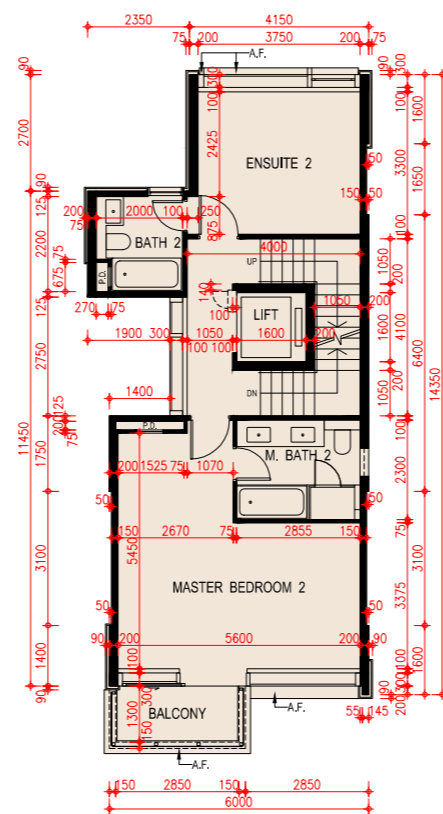
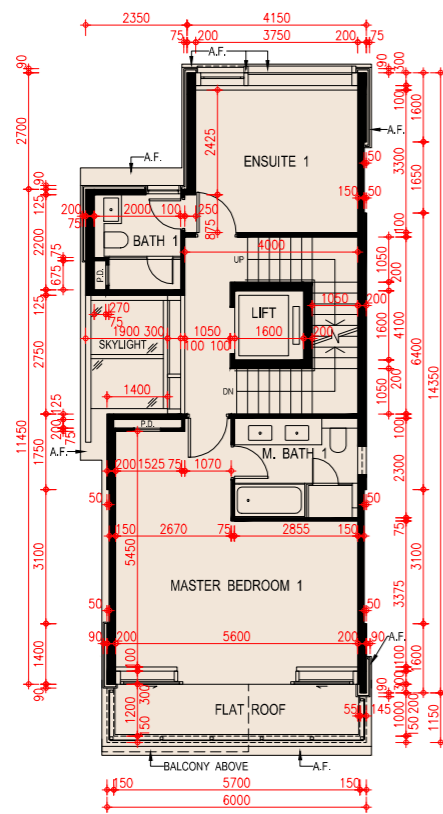
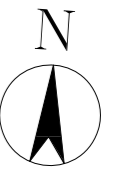

1/F Plan  
一樓平面圖

2/F Plan  
二樓平面圖

Roof Plan  
天台平面圖

Scale: 0M/米 5M/米  
比例:

# FLOOR PLANS OF RESIDENTIAL PROPERTIES IN THE DEVELOPMENT

## 發展項目的住宅物業的樓面平面圖

### House 23 23號洋房

Floor 樓層	The thickness of the floor slabs (excluding plaster) of each House (mm) 每座洋房的樓板(不包括灰泥)的厚度(毫米)	The floor-to-floor height of each House (mm) 每座洋房的層與層之間的高度(毫米)
Basement 地庫	170, 200	4550, 4850*
G/F 地下	125, 150, 250	3900, 4200, 4500*
1/F 1樓	125, 150, 250	3200, 3500
2/F 2樓	150	3500, 3900
Roof 天台	150	2350

The internal areas of the residential properties on the upper floors will generally be slightly larger than those on the lower floors because of the reducing thickness of the structural walls on the upper floors.

因住宅物業的較高樓層的結構牆的厚度遞減，較高樓層的內部面積，一般比較低樓層的內部面積稍大。

#### Notes:

- The dimensions of floor plans are all structural dimensions in millimeter.
- There may be architectural features and/or exposed pipes on external walls of the residential properties. For details, please refer to the latest approved building plans.
- Common pipes exposed and/or enclosed in cladding are located at/adjacent to flat roof and/or external wall of the residential properties. For details, please refer to the latest approved building plans.
- There are ceiling bulkheads and/or sunken slab at living/dining room, bedrooms, ensuites, study rooms, utility rooms, store rooms, corridors, bathrooms, powder rooms, lavatories and kitchen of some residential units for the air-conditioning system and/or mechanical and electrical services.
- Symbols of fittings and fitments shown in the floor plans, such as bathtubs, sink, water closets, shower, sink counter etc are architectural symbols extracted from the latest approved general building plans for general indication only.
- [\*] Inclusive of the thickness of mass concrete fill on sunken slab.

#### 備註：

- 平面圖所列之尺寸數字為以毫米標示之建築尺寸。
- 住宅物業的外牆設有建築裝飾及/或外露喉管。詳細資料請參考最新批准之建築圖則。
- 住宅物業的平台及/或外牆設有外露及/或外牆裝飾板內藏之公用喉管。詳細資料請參考最新批准的建築圖則。
- 部份住宅單位的客/飯廳、睡房、套房、書房、工作間、儲物室、走廊、浴室、客廳洗手間、洗手間及廚房有假天花及/或有跌級樓板用以裝置冷氣系統及/或機電設備。
- 樓面平面圖上所顯示的形象裝置符號，例如浴缸、洗滌盆、坐廁、花灑、洗滌盆櫃乃摘自最新的經批准的建築圖則，並只作一般性標誌。
- [\*] 包括跌級樓板上之混凝土填充層厚度。

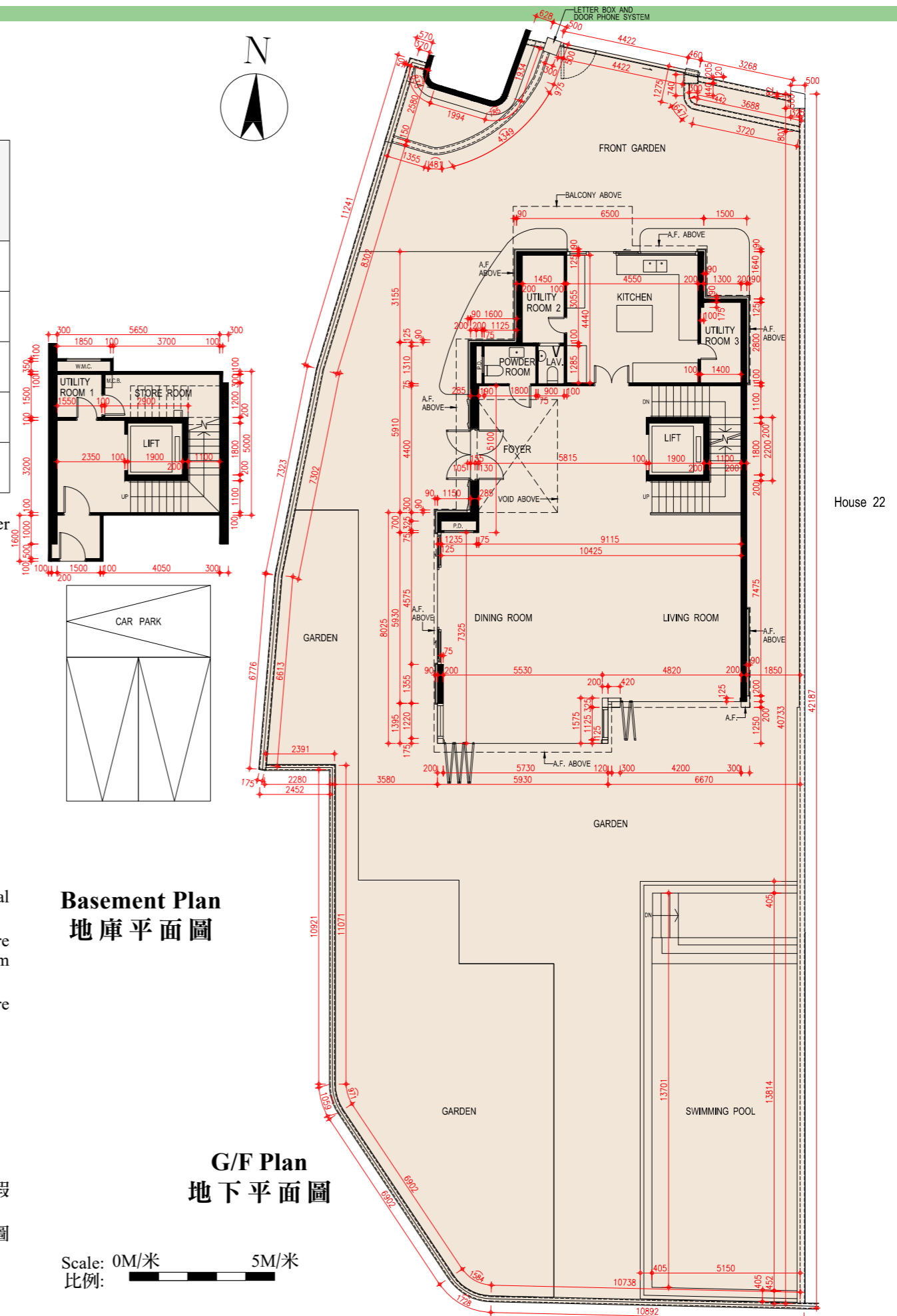

**Basement Plan**  
地庫平面圖

**G/F Plan**  
地下平面圖

Scale: 0M/米 5M/米  
比例: 1:500



FLOOR PLANS OF RESIDENTIAL PROPERTIES IN THE DEVELOPMENT

發展項目的住宅物業的樓面平面圖

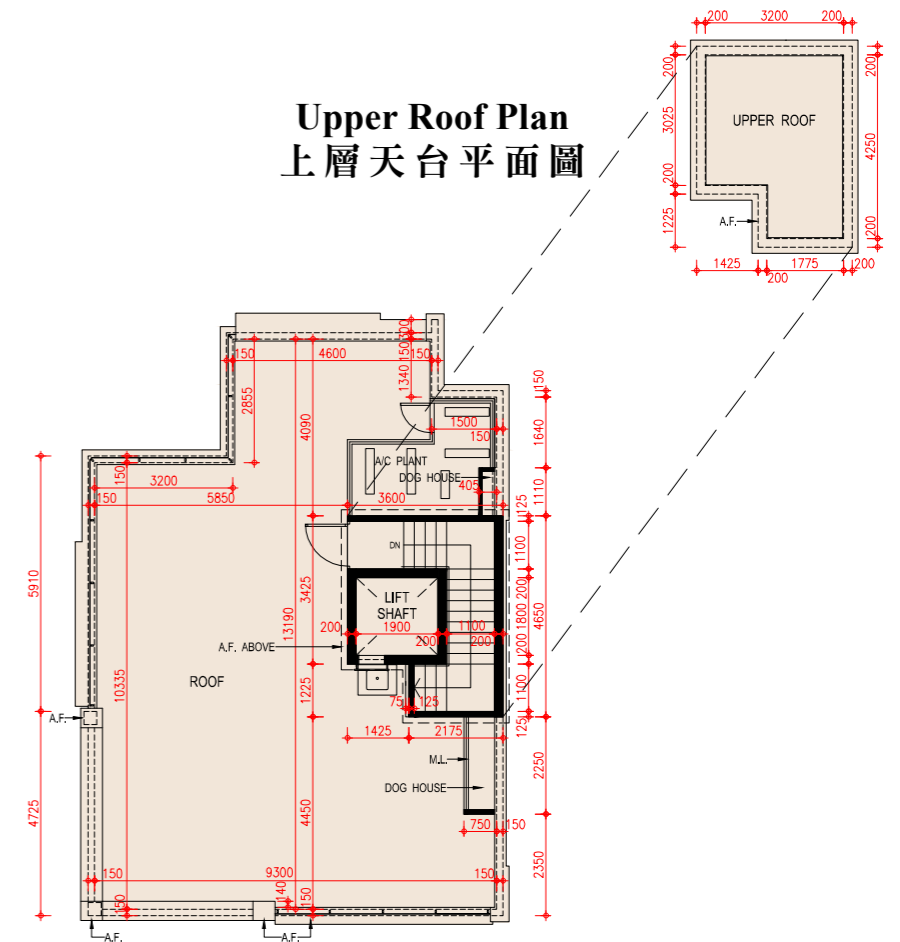
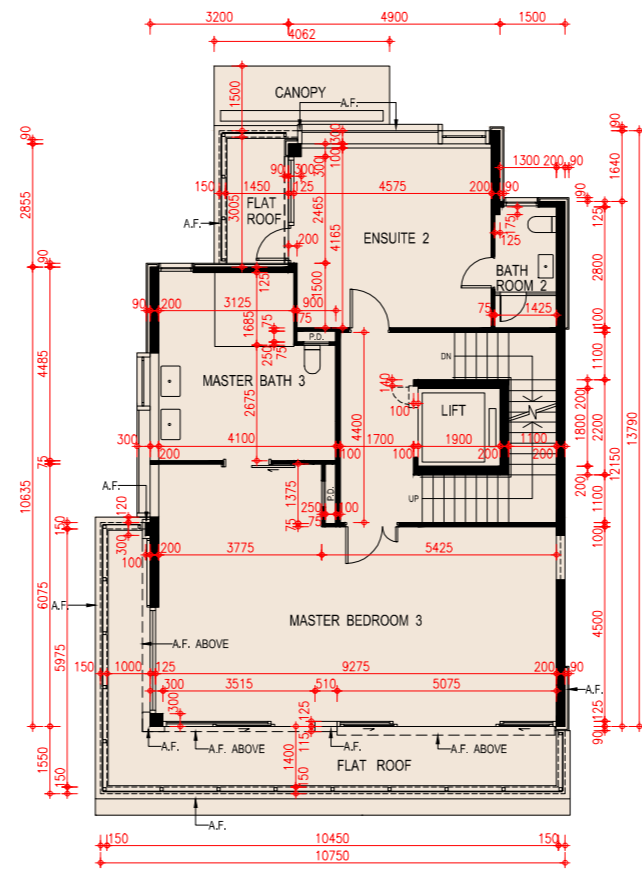
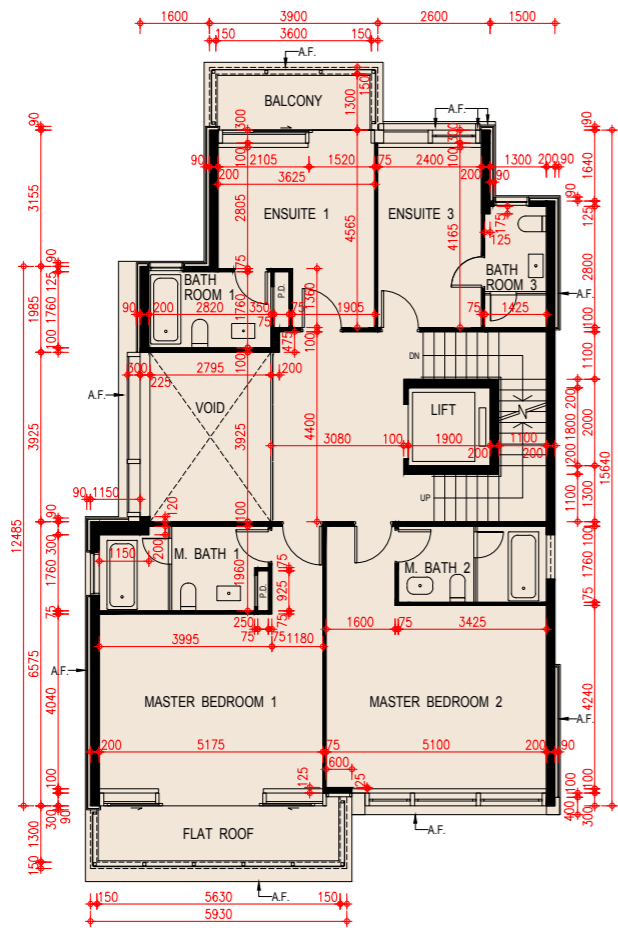
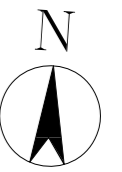

1/F Plan  
一樓平面圖

2/F Plan  
二樓平面圖

Roof Plan  
天台平面圖

Scale: 0M/米 5M/米  
比例:

# FLOOR PLANS OF RESIDENTIAL PROPERTIES IN THE DEVELOPMENT

## 發展項目的住宅物業的樓面平面圖

### House 25 25號洋房

Floor 樓層	The thickness of the floor slabs (excluding plaster) of each House (mm) 每座洋房的樓板(不包括灰泥)的厚度(毫米)	The floor-to-floor height of each House (mm) 每座洋房的層與層之間的高度(毫米)
Basement 地庫	200	4150
UG/F 上層地下	125, 150, 200	3300, 3350, 3600, 3900*, 3950*
1/F 1樓	125, 150, 200	3300, 3400
2/F 2樓	150, 200	3300, 3350, 3700
Roof 天台	150	2350

The internal areas of the residential properties on the upper floors will generally be slightly larger than those on the lower floors because of the reducing thickness of the structural walls on the upper floors.

因住宅物業的較高樓層的結構牆的厚度遞減，較高樓層的內部面積，一般比較低樓層的內部面積稍大。

#### Notes:

- The dimensions of floor plans are all structural dimensions in millimeter.
- There may be architectural features and/or exposed pipes on external walls of the residential properties. For details, please refer to the latest approved building plans.
- Common pipes exposed and/or enclosed in cladding are located at/adjacent to flat roof and/or external wall of the residential properties. For details, please refer to the latest approved building plans.
- There are ceiling bulkheads and/or sunken slab at living/dining room, bedrooms, ensuites, study rooms, utility rooms, store rooms, corridors, bathrooms, powder rooms, lavatories and kitchen of some residential units for the air-conditioning system and/or mechanical and electrical services.
- Symbols of fittings and fitments shown in the floor plans, such as bathtubs, sink, water closets, shower, sink counter etc are architectural symbols extracted from the latest approved general building plans for general indication only.
- [\*] Inclusive of the thickness of mass concrete fill on sunken slab.

#### 備註：

- 平面圖所列之尺寸數字為以毫米標示之建築尺寸。
- 住宅物業的外牆設有建築裝飾及/或外露喉管。詳細資料請參考最新批准之建築圖則。
- 住宅物業的平台及/或外牆設有外露及/或外牆裝飾板內藏之公用喉管。詳細資料請參考最新批准的建築圖則。
- 部份住宅單位的客/飯廳、睡房、套房、書房、工作間、儲物室、走廊、浴室、客廳洗手間、洗手間及廚房有假天花及/或有跌級樓板用以裝置冷氣系統及/或機電設備。
- 樓面平面圖上所顯示的形象裝置符號，例如浴缸、洗滌盆、坐廁、花灑、洗滌盆櫃乃摘自最新的經批准的建築圖則，並只作一般性標誌。
- [\*] 包括跌級樓板上之混凝土填充層厚度。

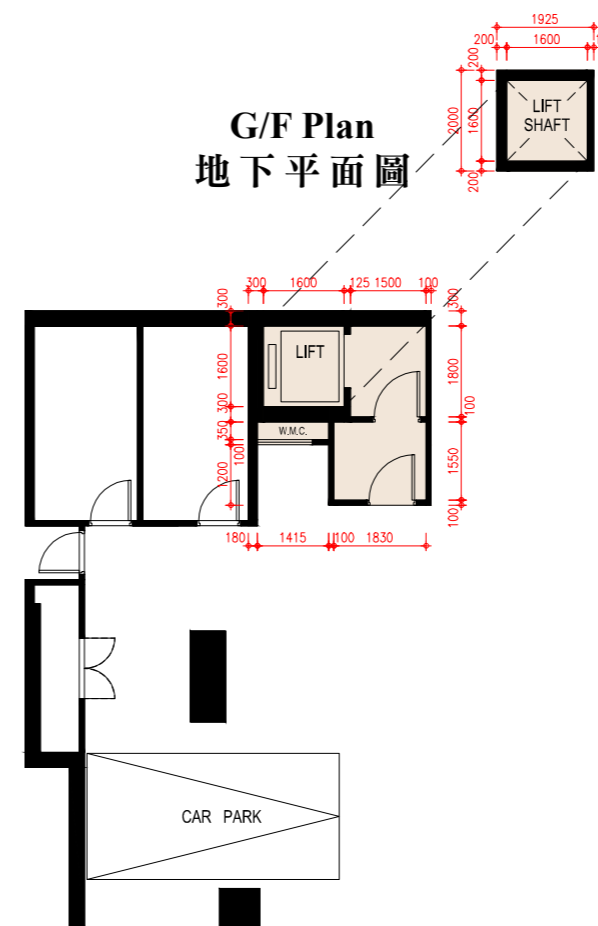

**Basement Plan  
地庫平面圖**

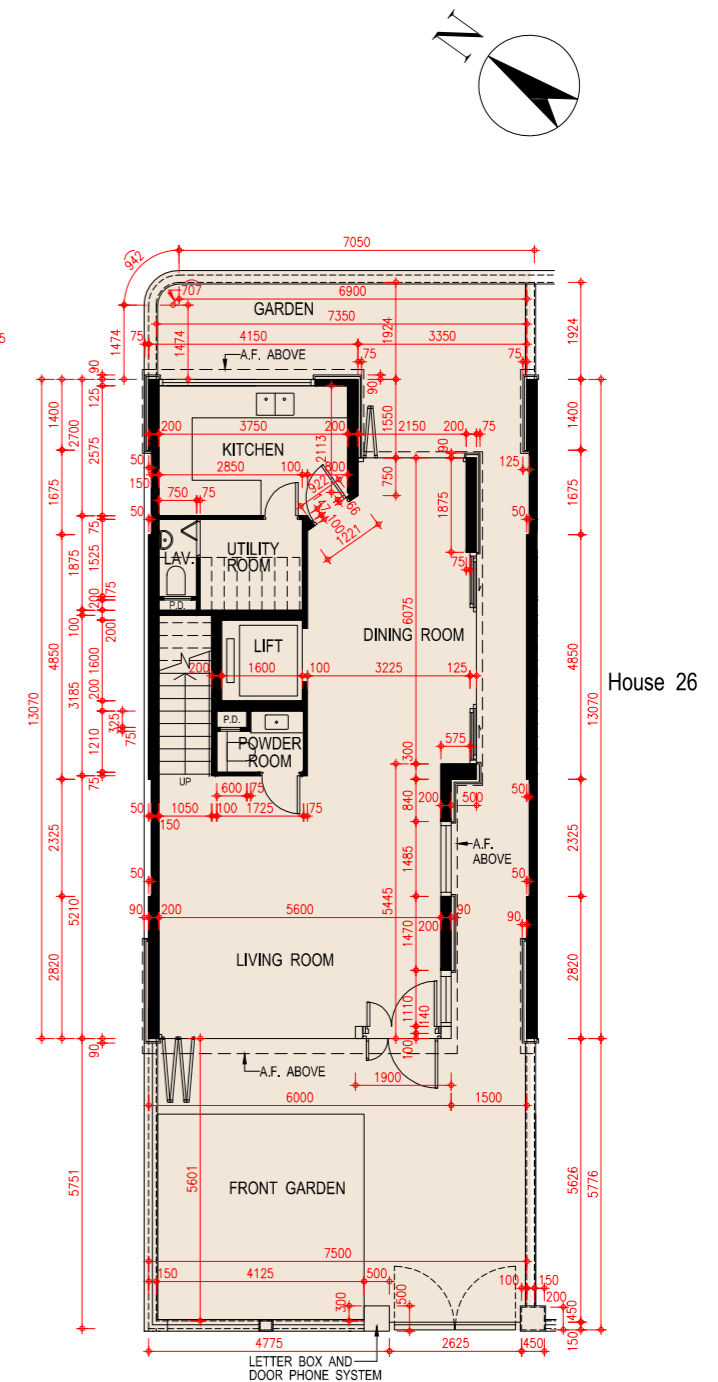

**Upper G/F Plan  
上層地下平面圖**

Scale: 0M/米 5M/米  
比例: 1:5000

FLOOR PLANS OF RESIDENTIAL PROPERTIES IN THE DEVELOPMENT

發展項目的住宅物業的樓面平面圖

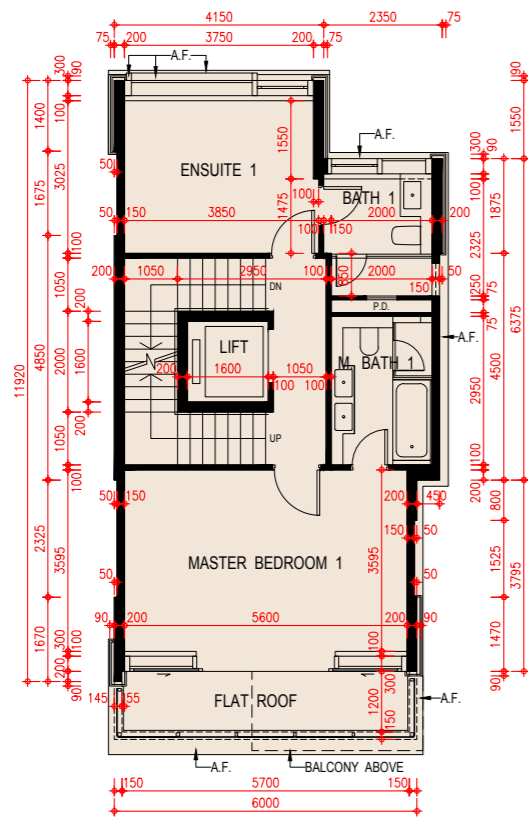

1/F Plan  
一樓平面圖

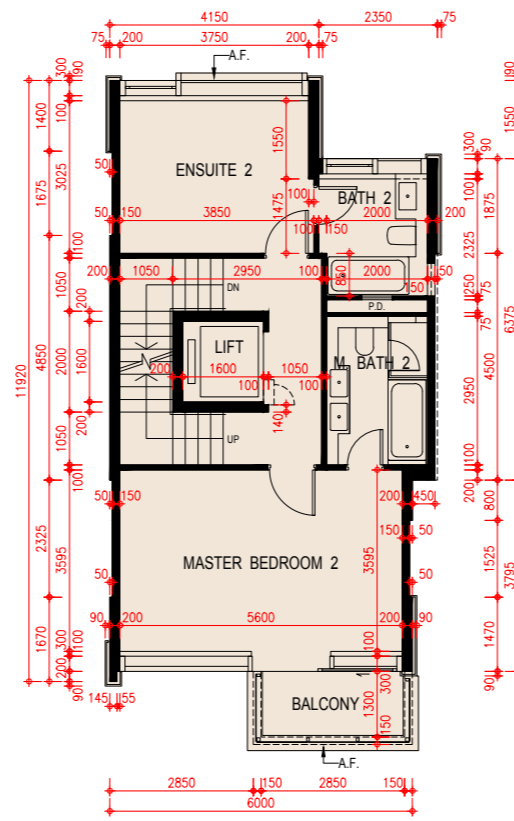

2/F Plan  
二樓平面圖

Upper Roof Plan  
上層天台平面圖

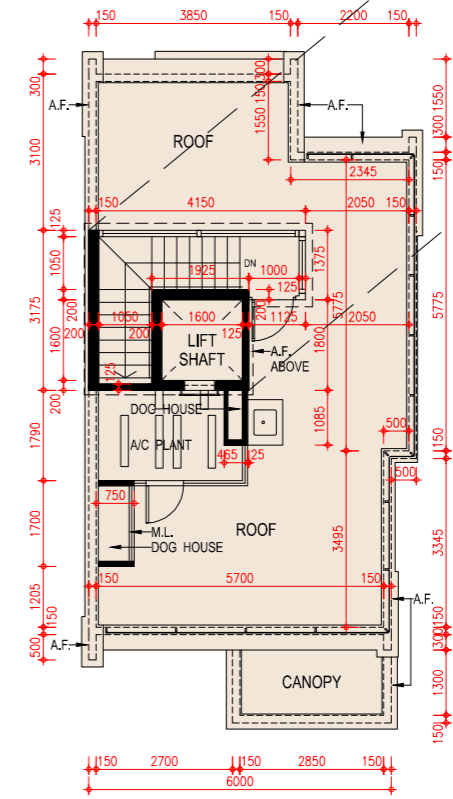

Roof Plan  
天台平面圖

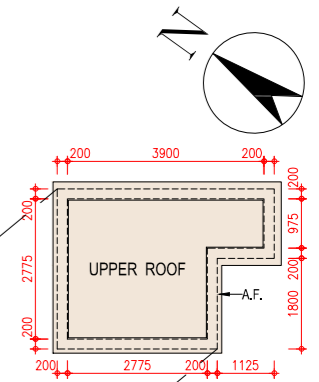

Scale: 0M/米 5M/米  
比例:

# FLOOR PLANS OF RESIDENTIAL PROPERTIES IN THE DEVELOPMENT

## 發展項目的住宅物業的樓面平面圖

### House 26 26號洋房

Floor 樓層	The thickness of the floor slabs (excluding plaster) of each House (mm) 每座洋房的樓板(不包括灰泥)的厚度(毫米)	The floor-to-floor height of each House (mm) 每座洋房的層與層之間的高度(毫米)
Basement 地庫	200	4150
UG/F 上層地下	125, 150, 200	3300, 3350, 3600, 3900*, 3950*
1/F 1樓	125, 150, 200	3300, 3400
2/F 2樓	150, 200	3300, 3350, 3700
Roof 天台	150	2350

The internal areas of the residential properties on the upper floors will generally be slightly larger than those on the lower floors because of the reducing thickness of the structural walls on the upper floors.

因住宅物業的較高樓層的結構牆的厚度遞減，較高樓層的內部面積，一般比較低樓層的內部面積稍大。

#### Notes:

- The dimensions of floor plans are all structural dimensions in millimeter.
- There may be architectural features and/or exposed pipes on external walls of the residential properties. For details, please refer to the latest approved building plans.
- Common pipes exposed and/or enclosed in cladding are located at/adjacent to flat roof and/or external wall of the residential properties. For details, please refer to the latest approved building plans.
- There are ceiling bulkheads and/or sunken slab at living/dining room, bedrooms, ensuites, study rooms, utility rooms, store rooms, corridors, bathrooms, powder rooms, lavatories and kitchen of some residential units for the air-conditioning system and/or mechanical and electrical services.
- Symbols of fittings and fitments shown in the floor plans, such as bathtubs, sink, water closets, shower, sink counter etc are architectural symbols extracted from the latest approved general building plans for general indication only.
- [\*] Inclusive of the thickness of mass concrete fill on sunken slab.

#### 備註：

- 平面圖所列之尺寸數字為以毫米標示之建築尺寸。
- 住宅物業的外牆設有建築裝飾及/或外露喉管。詳細資料請參考最新批准之建築圖則。
- 住宅物業的平台及/或外牆設有外露及/或外牆裝飾板內藏之公用喉管。詳細資料請參考最新批准的建築圖則。
- 部份住宅單位的客/飯廳、睡房、套房、書房、工作間、儲物室、走廊、浴室、客廳洗手間、洗手間及廚房有假天花及/或有跌級樓板用以裝置冷氣系統及/或機電設備。
- 樓面平面圖上所顯示的形象裝置符號，例如浴缸、洗滌盆、坐廁、花灑、洗滌盆櫃乃摘自最新的經批准的建築圖則，並只作一般性標誌。
- [\*] 包括跌級樓板上之混凝土填充層厚度。

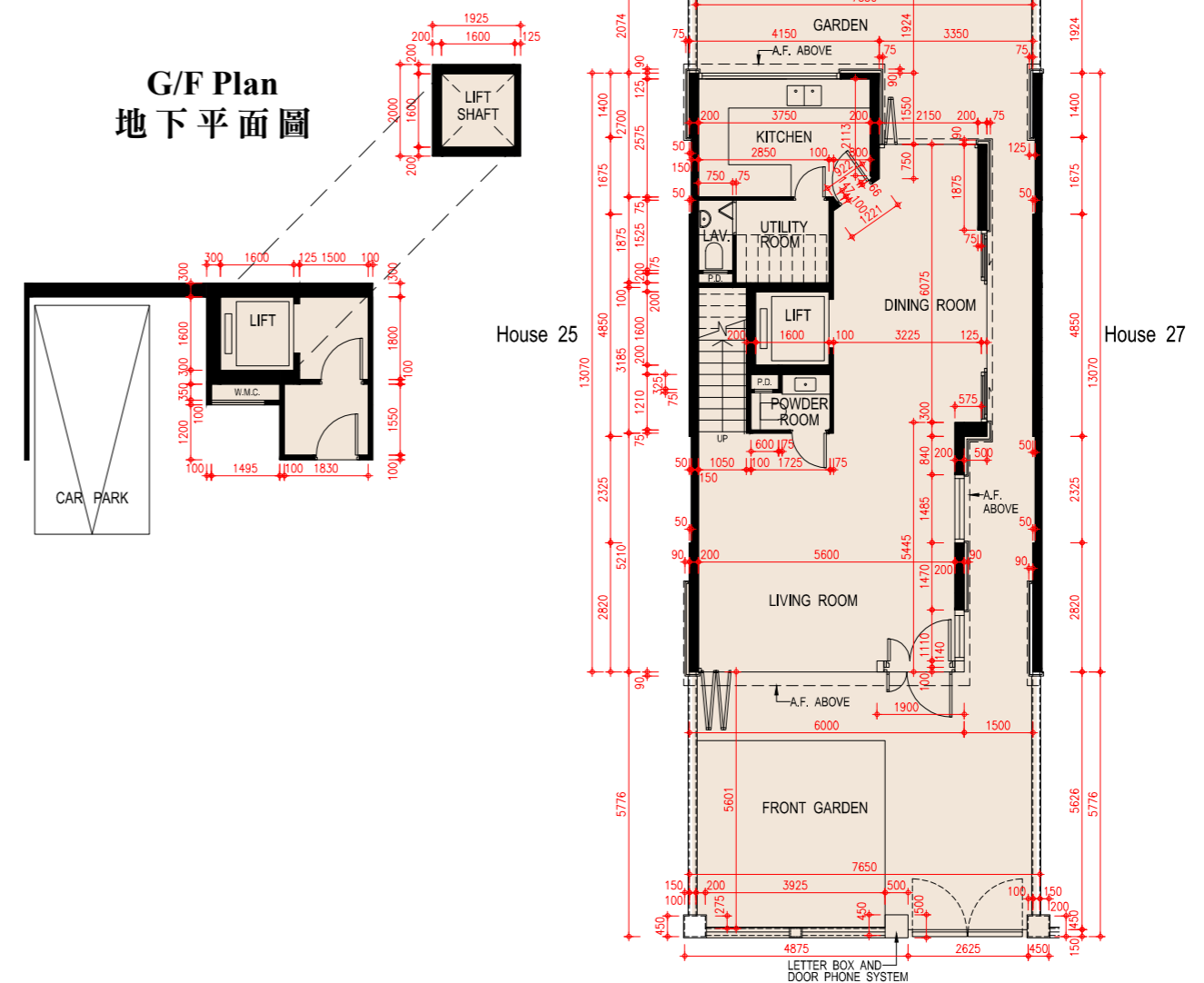
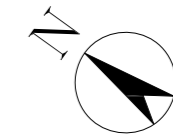

Basement Plan  
地庫平面圖

Upper G/F Plan  
上層地下平面圖

Scale: 0M/米 5M/米  
比例: 1:5000

FLOOR PLANS OF RESIDENTIAL PROPERTIES IN THE DEVELOPMENT

發展項目的住宅物業的樓面平面圖

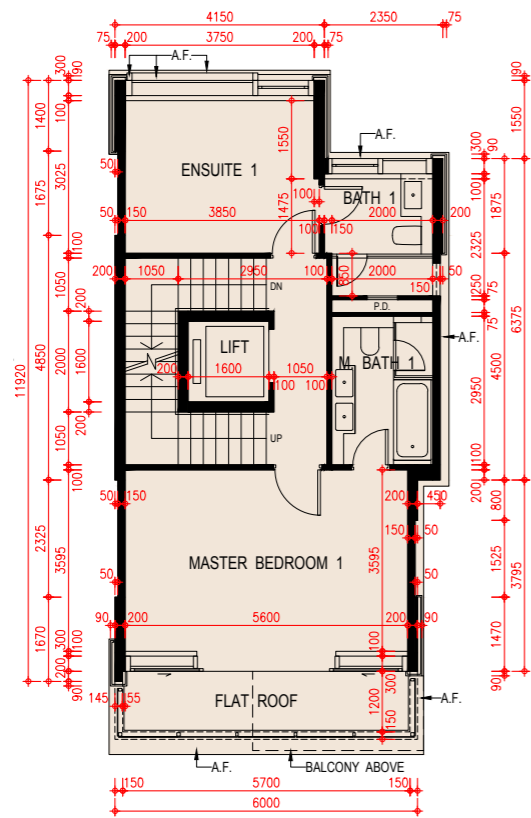
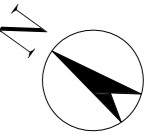

1/F Plan  
一樓平面圖

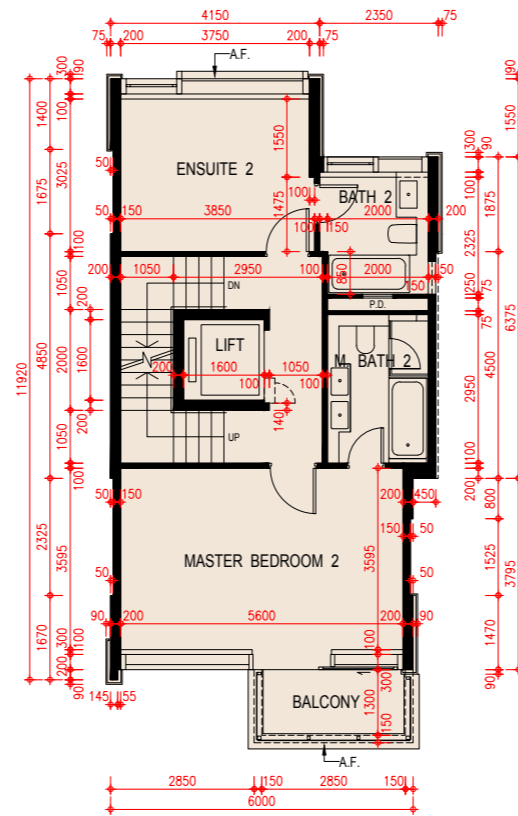

2/F Plan  
二樓平面圖

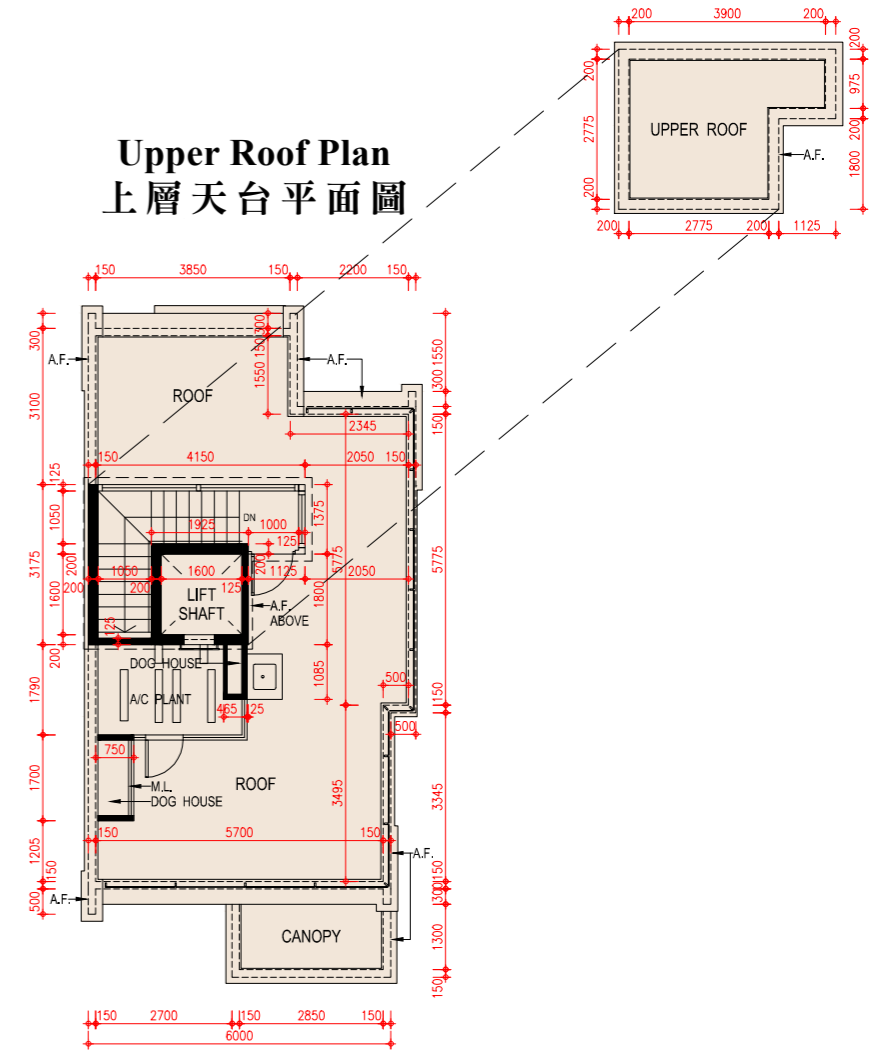

Roof Plan  
天台平面圖

Scale: 0M/米 5M/米  
比例:



# FLOOR PLANS OF RESIDENTIAL PROPERTIES IN THE DEVELOPMENT

## 發展項目的住宅物業的樓面平面圖

### House 27 27號洋房

Floor 樓層	The thickness of the floor slabs (excluding plaster) of each House (mm) 每座洋房的樓板(不包括灰泥)的厚度(毫米)	The floor-to-floor height of each House (mm) 每座洋房的層與層之間的高度(毫米)
Basement 地庫	200	4150
UG/F 上層地下	125, 150, 200	3300, 3350, 3600, 3900*, 3950*
1/F 1樓	125, 150, 200	3300, 3400
2/F 2樓	150, 200	3300, 3350, 3700
Roof 天台	150	2350

The internal areas of the residential properties on the upper floors will generally be slightly larger than those on the lower floors because of the reducing thickness of the structural walls on the upper floors.

因住宅物業的較高樓層的結構牆的厚度遞減，較高樓層的內部面積，一般比較低樓層的內部面積稍大。

#### Notes:

- The dimensions of floor plans are all structural dimensions in millimeter.
- There may be architectural features and/or exposed pipes on external walls of the residential properties. For details, please refer to the latest approved building plans.
- Common pipes exposed and/or enclosed in cladding are located at/adjacent to flat roof and/or external wall of the residential properties. For details, please refer to the latest approved building plans.
- There are ceiling bulkheads and/or sunken slab at living/dining room, bedrooms, ensuites, study rooms, utility rooms, store rooms, corridors, bathrooms, powder rooms, lavatories and kitchen of some residential units for the air-conditioning system and/or mechanical and electrical services.
- Symbols of fittings and fitments shown in the floor plans, such as bathtubs, sink, water closets, shower, sink counter etc are architectural symbols extracted from the latest approved general building plans for general indication only.
- [\*] Inclusive of the thickness of mass concrete fill on sunken slab.

#### 備註：

- 平面圖所列之尺寸數字為以毫米標示之建築尺寸。
- 住宅物業的外牆設有建築裝飾及/或外露喉管。詳細資料請參考最新批准之建築圖則。
- 住宅物業的平台及/或外牆設有外露及/或外牆裝飾板內藏之公用喉管。詳細資料請參考最新批准的建築圖則。
- 部份住宅單位的客/飯廳、睡房、套房、書房、工作間、儲物室、走廊、浴室、客廳洗手間、洗手間及廚房有假天花及/或有跌級樓板用以裝置冷氣系統及/或機電設備。
- 樓面平面圖上所顯示的形象裝置符號，例如浴缸、洗滌盆、坐廁、花灑、洗滌盆櫃乃摘自最新的經批准的建築圖則，並只作一般性標誌。
- [\*] 包括跌級樓板上之混凝土填充層厚度。

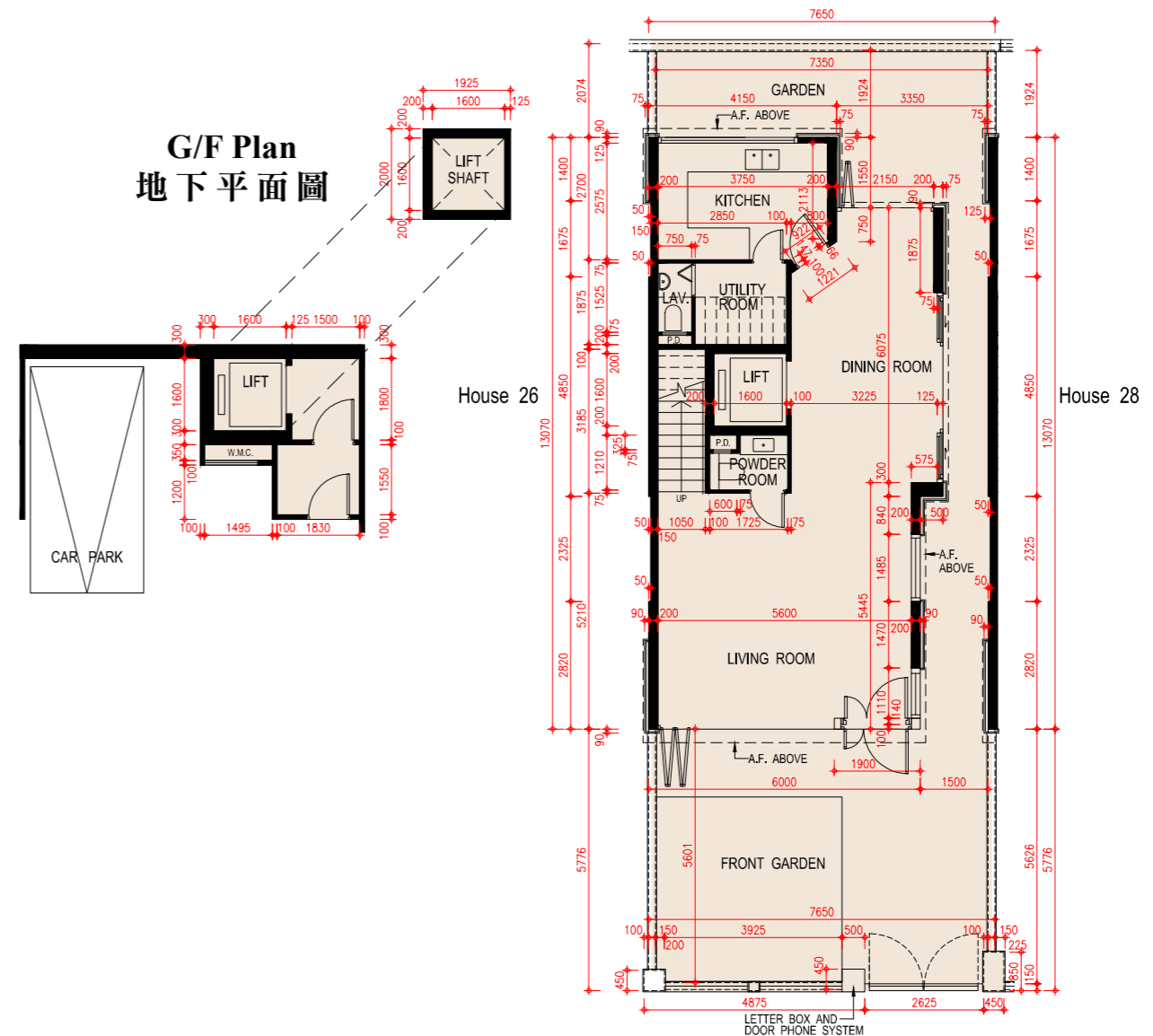
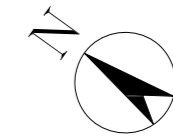

**Basement Plan**  
地庫平面圖

**Upper G/F Plan**  
上層地下平面圖

Scale: 0M/米 5M/米  
比例:

FLOOR PLANS OF RESIDENTIAL PROPERTIES IN THE DEVELOPMENT

發展項目的住宅物業的樓面平面圖

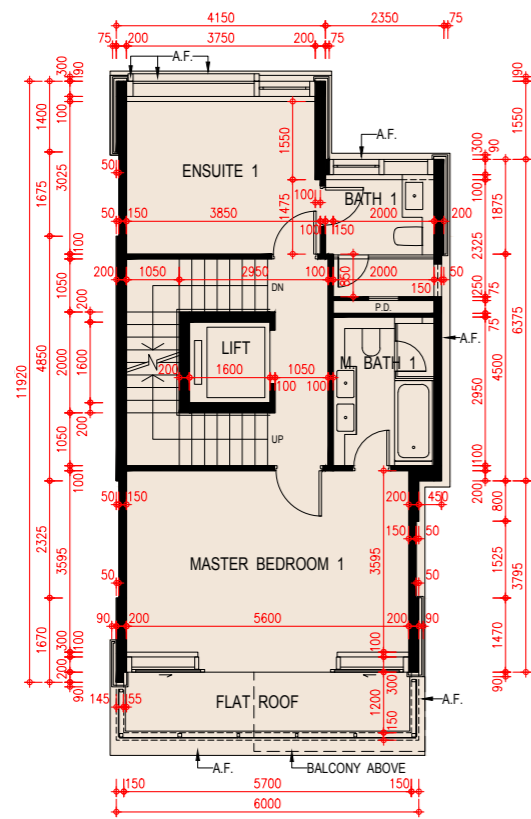
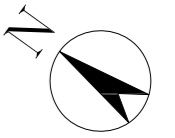

1/F Plan  
一樓平面圖

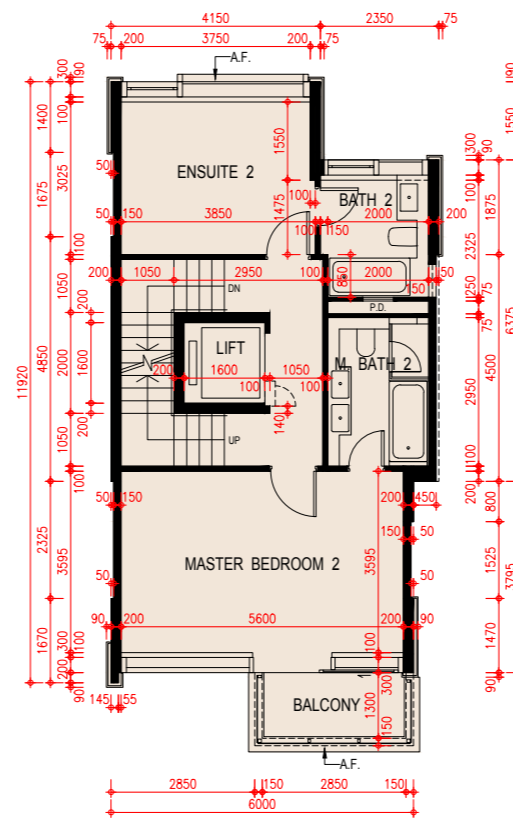

2/F Plan  
二樓平面圖

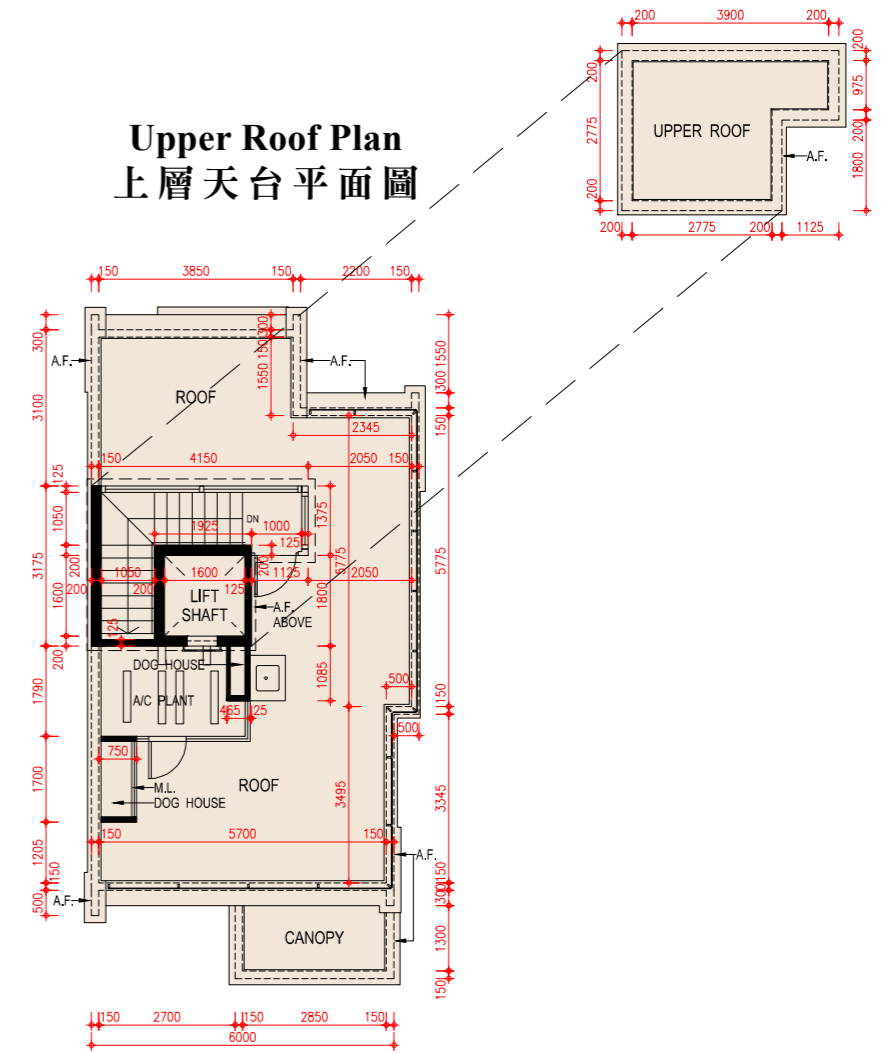

Upper Roof Plan  
上層天台平面圖

Scale: 0M/米 5M/米  
比例: 5M/米

# FLOOR PLANS OF RESIDENTIAL PROPERTIES IN THE DEVELOPMENT

## 發展項目的住宅物業的樓面平面圖

### House 28 28號洋房

Floor 樓層	The thickness of the floor slabs (excluding plaster) of each House (mm) 每座洋房的樓板(不包括灰泥)的厚度(毫米)	The floor-to-floor height of each House (mm) 每座洋房的層與層之間的高度(毫米)
Basement 地庫	200	4150
UG/F 上層地下	125, 150, 200	3300, 3350, 3600, 3900*, 3950*
1/F 1樓	125, 150, 200	3300, 3400
2/F 2樓	150, 200	3300, 3350, 3700
Roof 天台	150	2350

The internal areas of the residential properties on the upper floors will generally be slightly larger than those on the lower floors because of the reducing thickness of the structural walls on the upper floors.

因住宅物業的較高樓層的結構牆的厚度遞減，較高樓層的內部面積，一般比較低樓層的內部面積稍大。

#### Notes:

- The dimensions of floor plans are all structural dimensions in millimeter.
- There may be architectural features and/or exposed pipes on external walls of the residential properties. For details, please refer to the latest approved building plans.
- Common pipes exposed and/or enclosed in cladding are located at/adjacent to flat roof and/or external wall of the residential properties. For details, please refer to the latest approved building plans.
- There are ceiling bulkheads and/or sunken slab at living/dining room, bedrooms, ensuites, study rooms, utility rooms, store rooms, corridors, bathrooms, powder rooms, lavatories and kitchen of some residential units for the air-conditioning system and/or mechanical and electrical services.
- Symbols of fittings and fitments shown in the floor plans, such as bathtubs, sink, water closets, shower, sink counter etc are architectural symbols extracted from the latest approved general building plans for general indication only.
- [\*] Inclusive of the thickness of mass concrete fill on sunken slab.

#### 備註：

- 平面圖所列之尺寸數字為以毫米標示之建築尺寸。
- 住宅物業的外牆設有建築裝飾及/或外露喉管。詳細資料請參考最新批准之建築圖則。
- 住宅物業的平台及/或外牆設有外露及/或外牆裝飾板內藏之公用喉管。詳細資料請參考最新批准的建築圖則。
- 部份住宅單位的客/飯廳、睡房、套房、書房、工作間、儲物室、走廊、浴室、客廳洗手間、洗手間及廚房有假天花及/或有跌級樓板用以裝置冷氣系統及/或機電設備。
- 樓面平面圖上所顯示的形象裝置符號，例如浴缸、洗滌盆、坐廁、花灑、洗滌盆櫃乃摘自最新的經批准的建築圖則，並只作一般性標誌。
- [\*] 包括跌級樓板上之混凝土填充層厚度。

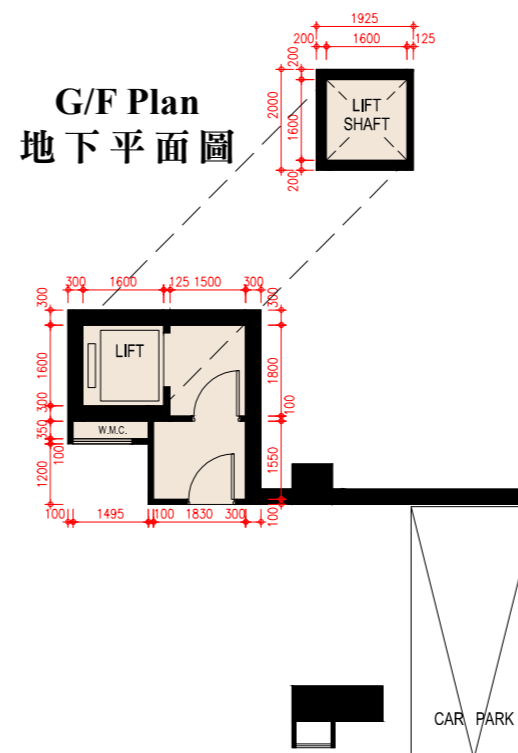
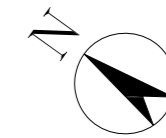

Basement Plan  
地庫平面圖

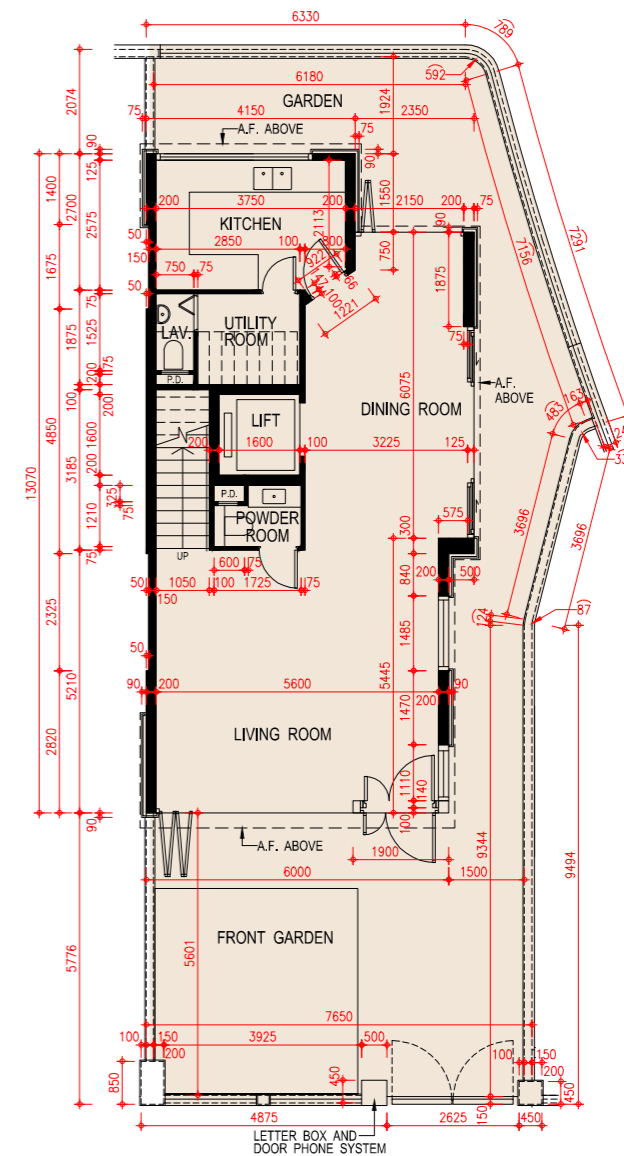

Upper G/F Plan  
上層地下平面圖

Scale: 0M/米 5M/米  
比例:

**FLOOR PLANS OF RESIDENTIAL PROPERTIES IN THE DEVELOPMENT**  
**發展項目的住宅物業的樓面平面圖**

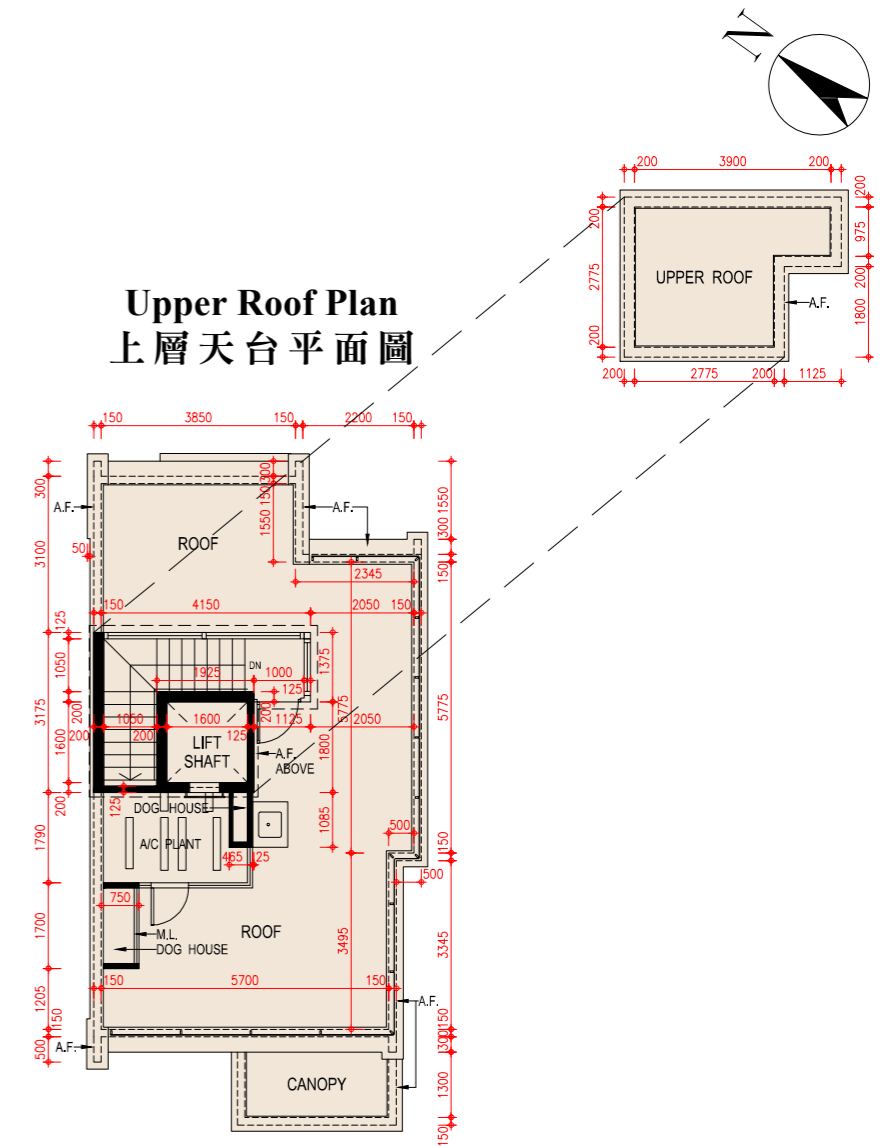
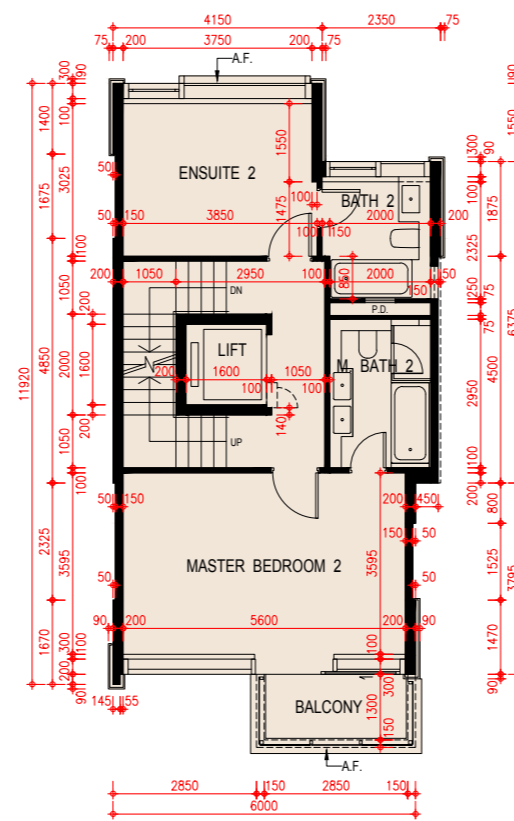
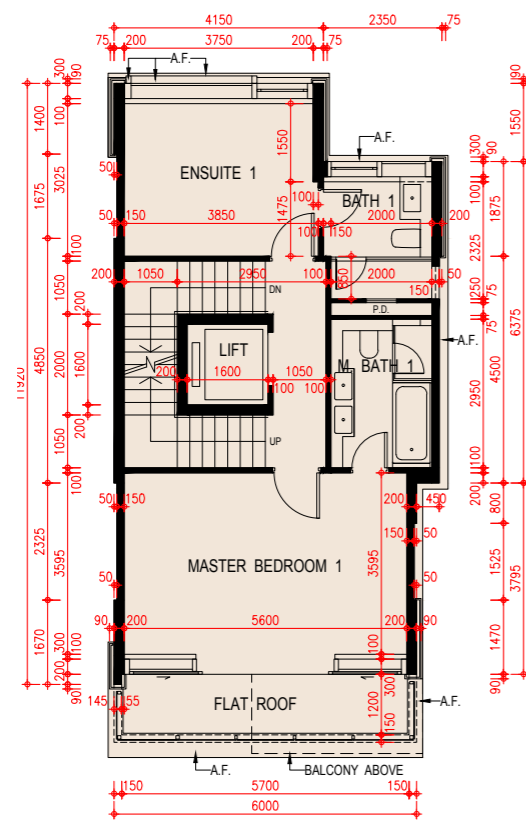

1/F Plan  
一樓平面圖

2/F Plan  
二樓平面圖

Roof Plan  
天台平面圖

Scale: 0M/米 5M/米  
 比例:

**Tower 1**

**第1座**

**G/F Plan**

**地下平面圖**

	Tower 1 第1座
Floor 樓層	G/F 地下
Flat 單位	Garden Duplex
The thickness of the floor slabs (excluding plaster) of each residential property (mm) 每個住宅物業的樓板(不包括灰泥)的厚度(毫米)	125, 150, 200
The floor-to-floor heights of each residential property (mm) 每個住宅物業的層與層之間的高度(毫米)	3250, 3450, 3575, 3800*, 6250, 6350, 6600

The internal areas of the residential properties on the upper floors will generally be slightly larger than those on the lower floors because of the reducing thickness of the structural walls on the upper floors.

因住宅物業的較高樓層的結構牆的厚度遞減，較高樓層的內部面積，一般比較低樓層的內部面積稍大。

Notes:

1. The dimensions of floor plans are all structural dimensions in millimeter.
2. There may be architectural features and/or exposed pipes on external walls of the residential properties. For details, please refer to the latest approved building plans.
3. Common pipes exposed and/or enclosed in cladding are located at/adjacent to flat roof and/or external wall of the residential properties. For details, please refer to the latest approved building plans.
4. There are ceiling bulkheads and/or sunken slab at living/dining room, bedrooms, ensuites, study rooms, utility rooms, store rooms, corridors, bathrooms, powder rooms, lavatories and kitchen of some residential units for the air-conditioning system and/or mechanical and electrical services.
5. Symbols of fittings and fitments shown in the floor plans, such as bathtubs, sink, water closets, shower, sink counter etc are architectural symbols extracted from the latest approved general building plans for general indication only.
6. [\*] Inclusive of the thickness of mass concrete fill on sunken slab.

備註：

1. 平面圖所列之尺寸數字為以毫米標示之建築尺寸。
2. 住宅物業的外牆設有建築裝飾及/或外露喉管。詳細資料請參考最新批准之建築圖則。
3. 住宅物業的平台及/或外牆設有外露及/或外牆裝飾板內藏之公用喉管。詳細資料請參考最新批准的建築圖則。
4. 部份住宅單位的客/飯廳、睡房、套房、書房、工作間、儲物室、走廊、浴室、客廳洗手間、洗手間及廚房有假天花及/或有跌級樓板用以裝置冷氣系統及/或機電設備。
5. 樓面平面圖上所顯示的形象裝置符號，例如浴缸、洗滌盆、坐廁、花灑、洗滌盆櫃乃摘自最新的經批准的建築圖則，並只作一般性標誌。
6. [\*] 包括跌級樓板上之混凝土填充層厚度。



FLOOR PLANS OF RESIDENTIAL PROPERTIES IN THE DEVELOPMENT  
 發展項目的住宅物業的樓面平面圖

Tower 1  
 第1座

G/F Plan  
 地下平面圖

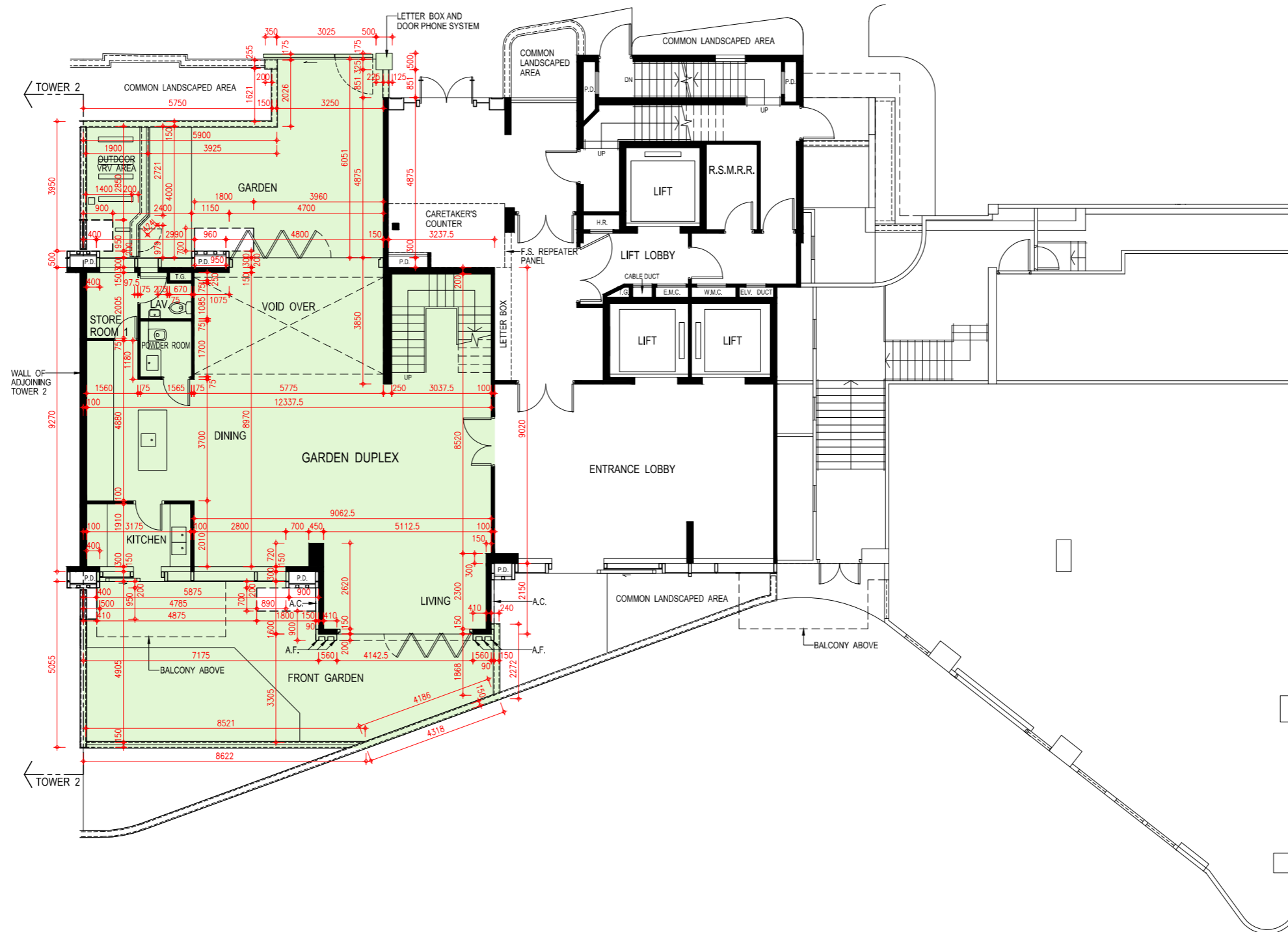
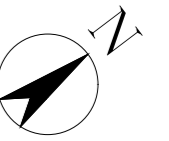

Scale: 0M/米 5M/米  
 比例: 0 5

## FLOOR PLANS OF RESIDENTIAL PROPERTIES IN THE DEVELOPMENT

### 發展項目的住宅物業的樓面平面圖

#### Tower 1

#### 第1座

#### 1/F Plan

#### 1樓平面圖

	Tower 1 第1座	
Floor 樓層	1/F 1樓	
Flat 單位	Garden Duplex	• Terrace Apartment
The thickness of the floor slabs (excluding plaster) of each residential property (mm) 每個住宅物業的樓板(不包括灰泥)的厚度(毫米)	125, 150, 175	125, 150, 175
The floor-to-floor heights of each residential property (mm) 每個住宅物業的層與層之間的高度(毫米)	2800, 2900, 3125, 3150	2800, 2900, 3150, 3150*, 3200*, 3250*, 3500*, 3550*

The internal areas of the residential properties on the upper floors will generally be slightly larger than those on the lower floors because of the reducing thickness of the structural walls on the upper floors.

因住宅物業的較高樓層的結構牆的厚度遞減，較高樓層的內部面積，一般比較低樓層的內部面積稍大。

#### Notes:

- The dimensions of floor plans are all structural dimensions in millimeter.
- There may be architectural features and/or exposed pipes on external walls of the residential properties. For details, please refer to the latest approved building plans.
- Common pipes exposed and/or enclosed in cladding are located at/adjacent to flat roof and/or external wall of the residential properties. For details, please refer to the latest approved building plans.
- There are ceiling bulkheads and/or sunken slab at living/dining room, bedrooms, ensuites, study rooms, utility rooms, store rooms, corridors, bathrooms, powder rooms, lavatories and kitchen of some residential units for the air-conditioning system and/or mechanical and electrical services.
- Symbols of fittings and fitments shown in the floor plans, such as bathtubs, sink, water closets, shower, sink counter etc are architectural symbols extracted from the latest approved general building plans for general indication only.
- “Terrace Apartment”, “Garden Apartment” and “Courtyard Penthouse” are names for marketing purposes only and will not appear in any Deed of Mutual Covenant, the Preliminary Agreement for Sale and Purchase, Agreement for Sale and Purchase, Assignment, or any other title deeds and documents relating to the Development. The names as appearing on the approved building plans are: Flat A on 1/F of Tower 1 for Terrace Apartment on 1/F of Tower 1; Flat B on G/F of Tower 2 for Garden Apartment on G/F of Tower 2; Flat B on G/F of Tower 3 for Garden Apartment on G/F of Tower 3; Flat A on G/F of Tower 7 for Garden Apartment on G/F of Tower 7; Penthouse on 11/F of Tower 7 for Courtyard Penthouse on 11/F of Tower 7; Flat B on G/F of Tower 8 for Garden Apartment on G/F of Tower 8; Penthouse on 11/F of Tower 8 for Courtyard Penthouse on 11/F of Tower 8.
- [\*] Inclusive of the thickness of mass concrete fill on sunken slab.

#### 備註：

- 平面圖所列之尺寸數字為以毫米標示之建築尺寸。
- 住宅物業的外牆設有建築裝飾及/或外露喉管。詳細資料請參考最新批准之建築圖則。
- 住宅物業的平台及/或外牆設有外露及/或外牆裝飾板內藏之公用喉管。詳細資料請參考最新批准的建築圖則。
- 部份住宅單位的客/飯廳、睡房、套房、書房、工作間、儲物室、走廊、浴室、客廳洗手間、洗手間及廚房有假天花及/或有跌級樓板用以裝置冷氣系統及/或機電設備。
- 樓面平面圖上所顯示的形象裝置符號，例如浴缸、洗滌盆、坐廁、花灑、洗滌盆櫃乃摘自最新的經批准的建築圖則，並只作一般性標誌。
- 「Terrace Apartment」、「Garden Apartment」及「Courtyard Penthouse」僅為市場推廣之用的名稱，並不會於關於發展項目的任何公契、臨時買賣合約、買賣合約、轉讓契及契據出現。經批准的建築圖則上顯示的名稱為：第1座1樓A單位（即第1座1樓Terrace Apartment）；第2座地下B單位（即第2座地下Garden Apartment）；第3座地下B單位（即第3座地下Garden Apartment）；第7座地下A單位（即第7座地下Garden Apartment）；第7座11樓Penthouse（即第7座11樓Courtyard Penthouse）；第8座地下B單位（即第8座地下Garden Apartment）；第8座11樓Penthouse（即第8座11樓Courtyard Penthouse）。
- [\*] 包括跌級樓板上之混凝土填充層厚度。



## FLOOR PLANS OF RESIDENTIAL PROPERTIES IN THE DEVELOPMENT

### 發展項目的住宅物業的樓面平面圖

#### Tower 1

#### 第1座

#### 2/F - 10/F Plan

#### 2樓至10樓平面圖

Floor 樓層	Tower 1 第1座			
	2/F-9/F 2樓至9樓		10/F 10樓	
	A	B	A	B
Flat 單位				
The thickness of the floor slabs (excluding plaster) of each residential property (mm) 每個住宅物業的樓板(不包括灰泥)的厚度(毫米)	125, 150, 175	125, 150, 175	125, 150, 175	125, 150, 175
The floor-to-floor heights of each residential property (mm) 每個住宅物業的層與層之間的高度(毫米)	3150, 3150*	3150, 3150*	3200, 3250, 3300*, 3450*, 3350, 3500, 3500*, 3550*, 3750*	3150, 3250, 3325, 3400*, 3475, 3500, 3500*, 3600*, 3675*, 3750*, 3850*

The internal areas of the residential properties on the upper floors will generally be slightly larger than those on the lower floors because of the reducing thickness of the structural walls on the upper floors.

因住宅物業的較高樓層的結構牆的厚度遞減，較高樓層的內部面積，一般比較低樓層的內部面積稍大。

#### Notes:

- The dimensions of floor plans are all structural dimensions in millimeter.
- There may be architectural features and/or exposed pipes on external walls of the residential properties. For details, please refer to the latest approved building plans.
- Common pipes exposed and/or enclosed in cladding are located at/adjacent to flat roof and/or external wall of the residential properties. For details, please refer to the latest approved building plans.
- There are ceiling bulkheads and/or sunken slab at living/dining room, bedrooms, ensuites, study rooms, utility rooms, store rooms, corridors, bathrooms, powder rooms, lavatories and kitchen of some residential units for the air-conditioning system and/or mechanical and electrical services.
- Symbols of fittings and fitments shown in the floor plans, such as bathtubs, sink, water closets, shower, sink counter etc are architectural symbols extracted from the latest approved general building plans for general indication only.
- 4/F is omitted.
- [\*] Inclusive of the thickness of mass concrete fill on sunken slab.

#### 備註：

- 平面圖所列之尺寸數字為以毫米標示之建築尺寸。
- 住宅物業的外牆設有建築裝飾及/或外露喉管。詳細資料請參考最新批准之建築圖則。
- 住宅物業的平台及/或外牆設有外露及/或外牆裝飾板內藏之公用喉管。詳細資料請參考最新批准的建築圖則。
- 部份住宅單位的客/飯廳、睡房、套房、書房、工作間、儲物室、走廊、浴室、客廳洗手間、洗手間及廚房有假天花及/或有跌級樓板用以裝置冷氣系統及/或機電設備。
- 樓面平面圖上所顯示的形象裝置符號，例如浴缸、洗滌盆、坐廁、花灑、洗滌盆櫃乃摘自最新的經批准的建築圖則，並只作一般性標誌。
- 不設4樓。
- [\*] 包括跌級樓板上之混凝土填充層厚度。

FLOOR PLANS OF RESIDENTIAL PROPERTIES IN THE DEVELOPMENT  
 發展項目的住宅物業的樓面平面圖

Tower 1  
 第1座

2/F - 10/F Plan  
 2樓至10樓平面圖

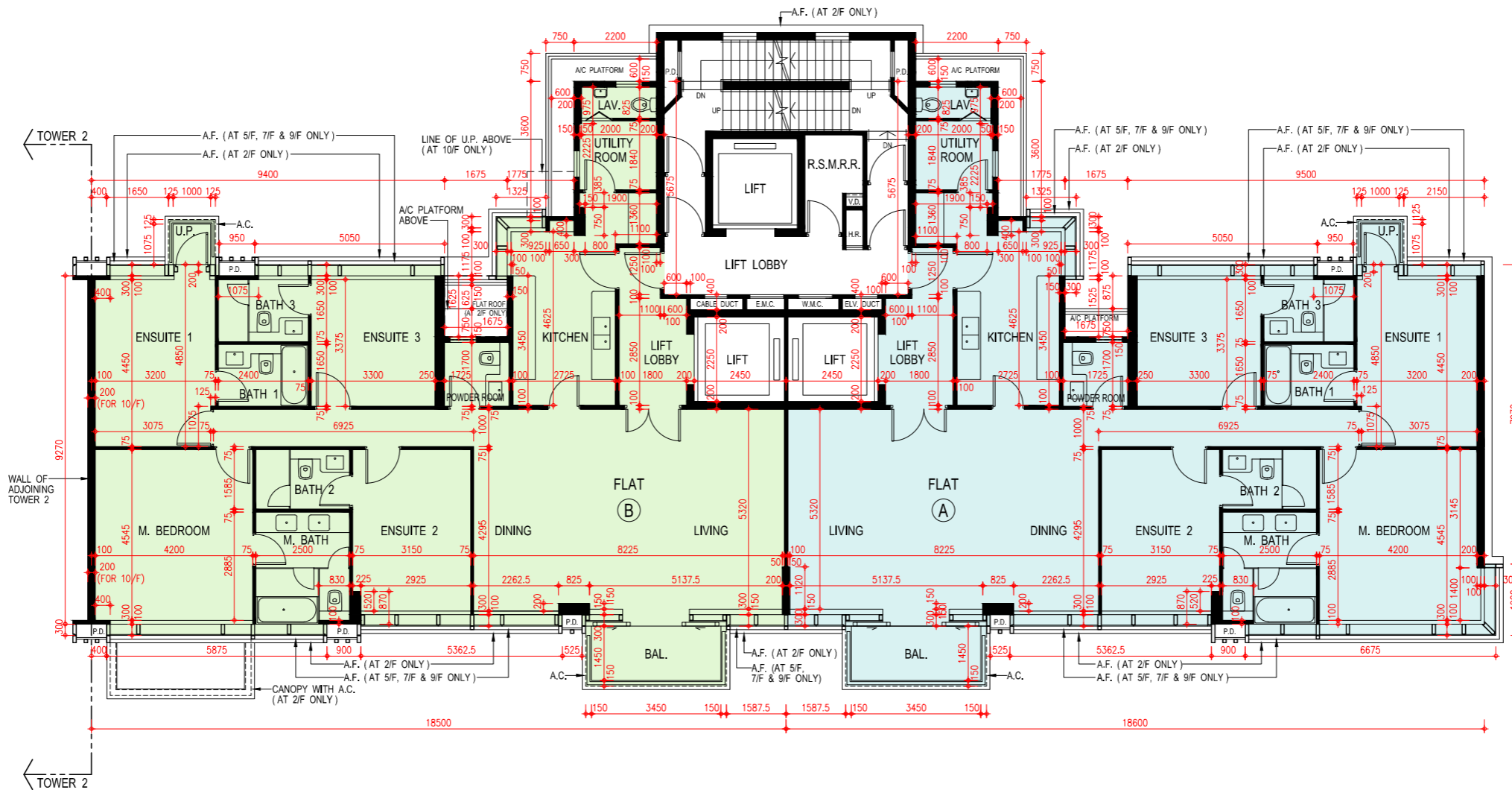
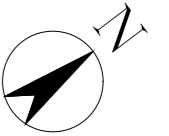

Scale: 0M/米 5M/米  
 比例: 80



**Tower 1**

**第 1 座**

**11/F Plan**

**11 樓平面圖**

	Tower 1 第1座
Floor 樓層	11/F 11樓
Flat 單位	Sky Pool Penthouse
The thickness of the floor slabs (excluding plaster) of each residential property (mm) 每個住宅物業的樓板(不包括灰泥)的厚度(毫米)	150, 175
The floor-to-floor heights of each residential property (mm) 每個住宅物業的層與層之間的高度(毫米)	3475, 3500, 3750*, 3850*

The internal areas of the residential properties on the upper floors will generally be slightly larger than those on the lower floors because of the reducing thickness of the structural walls on the upper floors.

因住宅物業的較高樓層的結構牆的厚度遞減，較高樓層的內部面積，一般比較低樓層的內部面積稍大。

Notes:

1. The dimensions of floor plans are all structural dimensions in millimeter.
2. There may be architectural features and/or exposed pipes on external walls of the residential properties. For details, please refer to the latest approved building plans.
3. Common pipes exposed and/or enclosed in cladding are located at/adjacent to flat roof and/or external wall of the residential properties. For details, please refer to the latest approved building plans.
4. There are ceiling bulkheads and/or sunken slab at living/dining room, bedrooms, ensuites, study rooms, utility rooms, store rooms, corridors, bathrooms, powder rooms, lavatories and kitchen of some residential units for the air-conditioning system and/or mechanical and electrical services.
5. Symbols of fittings and fitments shown in the floor plans, such as bathtubs, sink, water closets, shower, sink counter etc are architectural symbols extracted from the latest approved general building plans for general indication only.
6. [\*] Inclusive of the thickness of mass concrete fill on sunken slab.

備註：

1. 平面圖所列之尺寸數字為以毫米標示之建築尺寸。
2. 住宅物業的外牆設有建築裝飾及/或外露喉管。詳細資料請參考最新批准之建築圖則。
3. 住宅物業的平台及/或外牆設有外露及/或外牆裝飾板內藏之公用喉管。詳細資料請參考最新批准的建築圖則。
4. 部份住宅單位的客/飯廳、睡房、套房、書房、工作間、儲物室、走廊、浴室、客廳洗手間、洗手間及廚房有假天花及/或有跌級樓板用以裝置冷氣系統及/或機電設備。
5. 樓面平面圖上所顯示的形象裝置符號，例如浴缸、洗滌盆、坐廁、花灑、洗滌盆櫃乃摘自最新的經批准的建築圖則，並只作一般性標誌。
6. [\*] 包括跌級樓板上之混凝土填充層厚度。



**Tower 1**

**第 1 座**

**Roof Floor Plan**

**天台平面圖**

	Tower 1 第1座
Floor 樓層	Roof 天台
Flat 單位	Sky Pool Penthouse
The thickness of the floor slabs (excluding plaster) of each residential property (mm) 每個住宅物業的樓板(不包括灰泥)的厚度(毫米)	Not Applicable 不適用
The floor-to-floor heights of each residential property (mm) 每個住宅物業的層與層之間的高度(毫米)	Not Applicable 不適用

The internal areas of the residential properties on the upper floors will generally be slightly larger than those on the lower floors because of the reducing thickness of the structural walls on the upper floors.

因住宅物業的較高樓層的結構牆的厚度遞減，較高樓層的內部面積，一般比較低樓層的內部面積稍大。

Notes:

1. The dimensions of floor plans are all structural dimensions in millimeter.
2. There may be architectural features and/or exposed pipes on external walls of the residential properties. For details, please refer to the latest approved building plans.
3. Common pipes exposed and/or enclosed in cladding are located at/adjacent to flat roof and/or external wall of the residential properties. For details, please refer to the latest approved building plans.
4. There are ceiling bulkheads and/or sunken slab at living/dining room, bedrooms, ensuites, study rooms, utility rooms, store rooms, corridors, bathrooms, powder rooms, lavatories and kitchen of some residential units for the air-conditioning system and/or mechanical and electrical services.
5. Symbols of fittings and fitments shown in the floor plans, such as bathtubs, sink, water closets, shower, sink counter etc are architectural symbols extracted from the latest approved general building plans for general indication only.

備註：

1. 平面圖所列之尺寸數字為以毫米標示之建築尺寸。
2. 住宅物業的外牆設有建築裝飾及/或外露喉管。詳細資料請參考最新批准之建築圖則。
3. 住宅物業的平台及/或外牆設有外露及/或外牆裝飾板內藏之公用喉管。詳細資料請參考最新批准的建築圖則。
4. 部份住宅單位的客/飯廳、睡房、套房、書房、工作間、儲物室、走廊、浴室、客廳洗手間、洗手間及廚房有假天花及/或有跌級樓板用以裝置冷氣系統及/或機電設備。
5. 樓面平面圖上所顯示的形象裝置符號，例如浴缸、洗滌盆、坐廁、花灑、洗滌盆櫃乃摘自最新的經批准的建築圖則，並只作一般性標誌。



## FLOOR PLANS OF RESIDENTIAL PROPERTIES IN THE DEVELOPMENT

### 發展項目的住宅物業的樓面平面圖

#### Tower 2

#### 第2座

#### G/F Plan

#### 地下平面圖

	Tower 2 第2座	
Floor 樓層	G/F 地下	
Flat 單位	Garden Duplex	• Garden Apartment
The thickness of the floor slabs (excluding plaster) of each residential property (mm) 每個住宅物業的樓板(不包括灰泥)的厚度(毫米)	125, 150, 200	125, 150, 200
The floor-to-floor heights of each residential property (mm) 每個住宅物業的層與層之間的高度(毫米)	3150, 3250, 3450, 3800*, 3825, 6250, 6350, 6600	3100, 3150, 3200, 3275, 3450, 3450*, 3500*, 3575, 3700*, 3800*

The internal areas of the residential properties on the upper floors will generally be slightly larger than those on the lower floors because of the reducing thickness of the structural walls on the upper floors.

因住宅物業的較高樓層的結構牆的厚度遞減，較高樓層的內部面積，一般比較低樓層的內部面積稍大。

#### Notes:

- The dimensions of floor plans are all structural dimensions in millimeter.
- There may be architectural features and/or exposed pipes on external walls of the residential properties. For details, please refer to the latest approved building plans.
- Common pipes exposed and/or enclosed in cladding are located at/adjacent to flat roof and/or external wall of the residential properties. For details, please refer to the latest approved building plans.
- There are ceiling bulkheads and/or sunken slab at living/dining room, bedrooms, ensembles, study rooms, utility rooms, store rooms, corridors, bathrooms, powder rooms, lavatories and kitchen of some residential units for the air-conditioning system and/or mechanical and electrical services.
- Symbols of fittings and fitments shown in the floor plans, such as bathtubs, sink, water closets, shower, sink counter etc are architectural symbols extracted from the latest approved general building plans for general indication only.
- “Terrace Apartment”, “Garden Apartment” and “Courtyard Penthouse” are names for marketing purposes only and will not appear in any Deed of Mutual Covenant, the Preliminary Agreement for Sale and Purchase, Agreement for Sale and Purchase, Assignment, or any other title deeds and documents relating to the Development. The names as appearing on the approved building plans are: Flat A on 1/F of Tower 1 for Terrace Apartment on 1/F of Tower 1; Flat B on G/F of Tower 2 for Garden Apartment on G/F of Tower 2; Flat B on G/F of Tower 3 for Garden Apartment on G/F of Tower 3; Flat A on G/F of Tower 7 for Garden Apartment on G/F of Tower 7; Penthouse on 11/F of Tower 7 for Courtyard Penthouse on 11/F of Tower 7; Flat B on G/F of Tower 8 for Garden Apartment on G/F of Tower 8; Penthouse on 11/F of Tower 8 for Courtyard Penthouse on 11/F of Tower 8.
- [\*] Inclusive of the thickness of mass concrete fill on sunken slab.

#### 備註：

- 平面圖所列之尺寸數字為以毫米標示之建築尺寸。
- 住宅物業的外牆設有建築裝飾及/或外露喉管。詳細資料請參考最新批准之建築圖則。
- 住宅物業的平台及/或外牆設有外露及/或外牆裝飾板內藏之公用喉管。詳細資料請參考最新批准的建築圖則。
- 部份住宅單位的客/飯廳、睡房、套房、書房、工作間、儲物室、走廊、浴室、客廳洗手間、洗手間及廚房有假天花及/或有跌級樓板用以裝置冷氣系統及/或機電設備。
- 樓面平面圖上所顯示的形象裝置符號，例如浴缸、洗滌盆、坐廁、花灑、洗滌盆櫃乃摘自最新的經批准的建築圖則，並只作一般性標誌。
- 「Terrace Apartment」、「Garden Apartment」及「Courtyard Penthouse」僅為市場推廣之用的名稱，並不會於關於發展項目的任何公契、臨時買賣合約、買賣合約、轉讓契及契據出現。經批准的建築圖則上顯示的名稱為：第1座1樓A單位（即第1座1樓Terrace Apartment）；第2座地下B單位（即第2座地下Garden Apartment）；第3座地下B單位（即第3座地下Garden Apartment）；第7座地下A單位（即第7座地下Garden Apartment）；第7座11樓Penthouse（即第7座11樓Courtyard Penthouse）；第8座地下B單位（即第8座地下Garden Apartment）；第8座11樓Penthouse（即第8座11樓Courtyard Penthouse）。
- [\*] 包括跌級樓板上之混凝土填充層厚度。



FLOOR PLANS OF RESIDENTIAL PROPERTIES IN THE DEVELOPMENT

發展項目的住宅物業的樓面平面圖

Tower 2  
第2座

G/F Plan  
地下平面圖

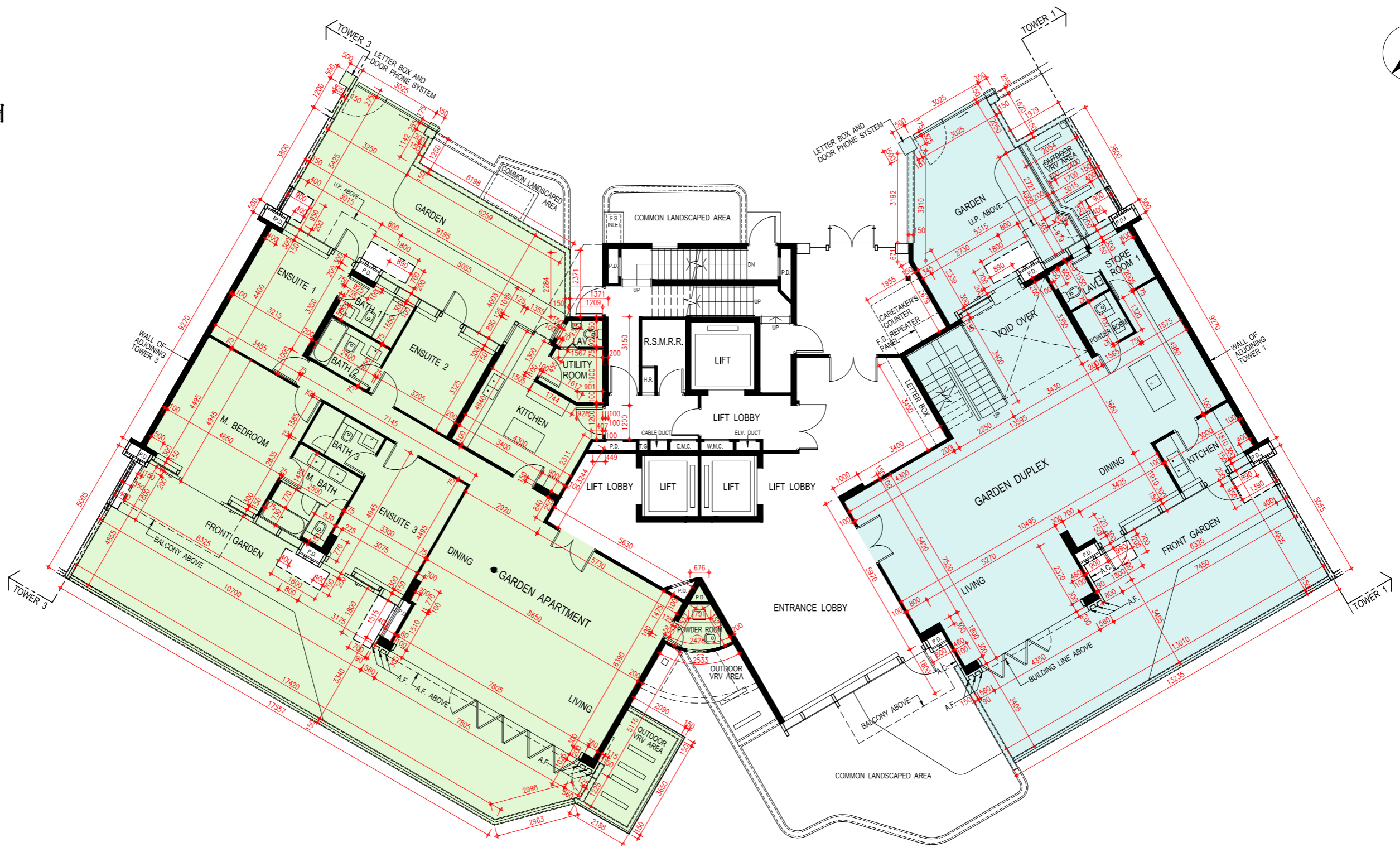
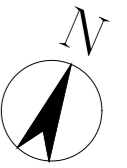

Scale: 0M/米 5M/米  
比例: 5M/米

**Tower 2**

**第2座**

**1/F Plan**

**1樓平面圖**

	Tower 2 第2座	
Floor 樓層	1/F 1樓	
Flat 單位	Garden Duplex	B
The thickness of the floor slabs (excluding plaster) of each residential property (mm) 每個住宅物業的樓板(不包括灰泥)的厚度(毫米)	125, 150, 200	125, 150, 200
The floor-to-floor heights of each residential property (mm) 每個住宅物業的層與層之間的高度(毫米)	2800, 2850, 2900, 3150	2800, 2850, 2900*, 3150, 3275, 3400*, 3450*, 3500*

The internal areas of the residential properties on the upper floors will generally be slightly larger than those on the lower floors because of the reducing thickness of the structural walls on the upper floors.

因住宅物業的較高樓層的結構牆的厚度遞減，較高樓層的內部面積，一般比較低樓層的內部面積稍大。

Notes:

1. The dimensions of floor plans are all structural dimensions in millimeter.
2. There may be architectural features and/or exposed pipes on external walls of the residential properties. For details, please refer to the latest approved building plans.
3. Common pipes exposed and/or enclosed in cladding are located at/adjacent to flat roof and/or external wall of the residential properties. For details, please refer to the latest approved building plans.
4. There are ceiling bulkheads and/or sunken slab at living/dining room, bedrooms, ensuites, study rooms, utility rooms, store rooms, corridors, bathrooms, powder rooms, lavatories and kitchen of some residential units for the air-conditioning system and/or mechanical and electrical services.
5. Symbols of fittings and fitments shown in the floor plans, such as bathtubs, sink, water closets, shower, sink counter etc are architectural symbols extracted from the latest approved general building plans for general indication only.
6. [\*] Inclusive of the thickness of mass concrete fill on sunken slab.

備註：

1. 平面圖所列之尺寸數字為以毫米標示之建築尺寸。
2. 住宅物業的外牆設有建築裝飾及/或外露喉管。詳細資料請參考最新批准之建築圖則。
3. 住宅物業的平台及/或外牆設有外露及/或外牆裝飾板內藏之公用喉管。詳細資料請參考最新批准的建築圖則。
4. 部份住宅單位的客/飯廳、睡房、套房、書房、工作間、儲物室、走廊、浴室、客廳洗手間、洗手間及廚房有假天花及/或有跌級樓板用以裝置冷氣系統及/或機電設備。
5. 樓面平面圖上所顯示的形象裝置符號，例如浴缸、洗滌盆、坐廁、花灑、洗滌盆櫃乃摘自最新的經批准的建築圖則，並只作一般性標誌。
6. [\*] 包括跌級樓板上之混凝土填充層厚度。

FLOOR PLANS OF RESIDENTIAL PROPERTIES IN THE DEVELOPMENT  
 發展項目的住宅物業的樓面平面圖

Tower 2  
 第2座

1/F Plan  
 1樓平面圖

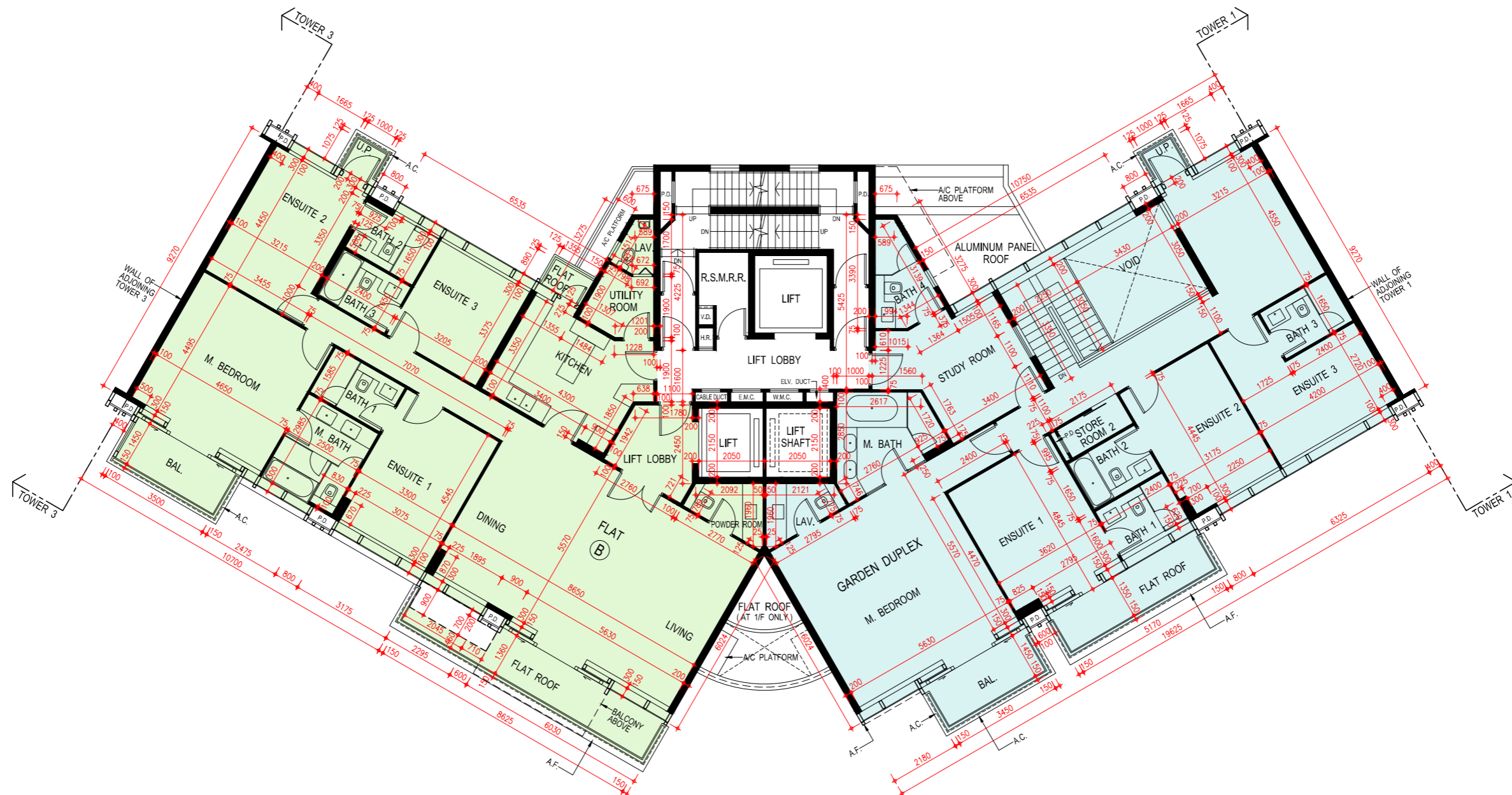
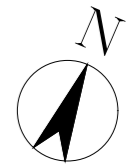

Scale: 0M/米 5M/米  
 比例: 5M/米

## FLOOR PLANS OF RESIDENTIAL PROPERTIES IN THE DEVELOPMENT

### 發展項目的住宅物業的樓面平面圖

#### Tower 2

#### 第2座

#### 2/F - 6/F, 9/F Plan

#### 2樓至6樓，9樓平面圖

Floor 樓層	Tower 2 第2座			
	2/F-6/F 2樓至6樓		9/F 9樓	
Flat 單位	A	B	A	B
The thickness of the floor slabs (excluding plaster) of each residential property (mm) 每個住宅物業的樓板(不包括灰泥)的厚度(毫米)	125, 150, 200	125, 150, 200	125, 150, 200	125, 150, 200
The floor-to-floor heights of each residential property (mm) 每個住宅物業的層與層之間的高度(毫米)	3150, 3150*	3150, 3150*	3050*, 3075, 3150, 3300*, 3325*, 3375*, 3400, 3400*, 3425*, 3650*, 3750*	3050*, 3075, 3150, 3300*, 3325*, 3375*, 3400, 3400*, 3425*, 3650*, 3750*

The internal areas of the residential properties on the upper floors will generally be slightly larger than those on the lower floors because of the reducing thickness of the structural walls on the upper floors.

因住宅物業的較高樓層的結構牆的厚度遞減，較高樓層的內部面積，一般比較低樓層的內部面積稍大。

#### Notes:

- The dimensions of floor plans are all structural dimensions in millimeter.
- There may be architectural features and/or exposed pipes on external walls of the residential properties. For details, please refer to the latest approved building plans.
- Common pipes exposed and/or enclosed in cladding are located at/adjacent to flat roof and/or external wall of the residential properties. For details, please refer to the latest approved building plans.
- There are ceiling bulkheads and/or sunken slab at living/dining room, bedrooms, ensuites, study rooms, utility rooms, store rooms, corridors, bathrooms, powder rooms, lavatories and kitchen of some residential units for the air-conditioning system and/or mechanical and electrical services.
- Symbols of fittings and fitments shown in the floor plans, such as bathtubs, sink, water closets, shower, sink counter etc are architectural symbols extracted from the latest approved general building plans for general indication only.
- 4/F is omitted.
- [\*] Inclusive of the thickness of mass concrete fill on sunken slab.

#### 備註：

- 平面圖所列之尺寸數字為以毫米標示之建築尺寸。
- 住宅物業的外牆設有建築裝飾及/或外露喉管。詳細資料請參考最新批准之建築圖則。
- 住宅物業的平台及/或外牆設有外露及/或外牆裝飾板內藏之公用喉管。詳細資料請參考最新批准的建築圖則。
- 部份住宅單位的客/飯廳、睡房、套房、書房、工作間、儲物室、走廊、浴室、客廳洗手間、洗手間及廚房有假天花及/或有跌級樓板用以裝置冷氣系統及/或機電設備。
- 樓面平面圖上所顯示的形象裝置符號，例如浴缸、洗滌盆、坐廁、花灑、洗滌盆櫃乃摘自最新的經批准的建築圖則，並只作一般性標誌。
- 不設4樓。
- [\*] 包括跌級樓板上之混凝土填充層厚度。



FLOOR PLANS OF RESIDENTIAL PROPERTIES IN THE DEVELOPMENT  
發展項目的住宅物業的樓面平面圖

Tower 2  
第2座

2/F - 6/F, 9/F Plan  
2樓至6樓，9樓平面圖

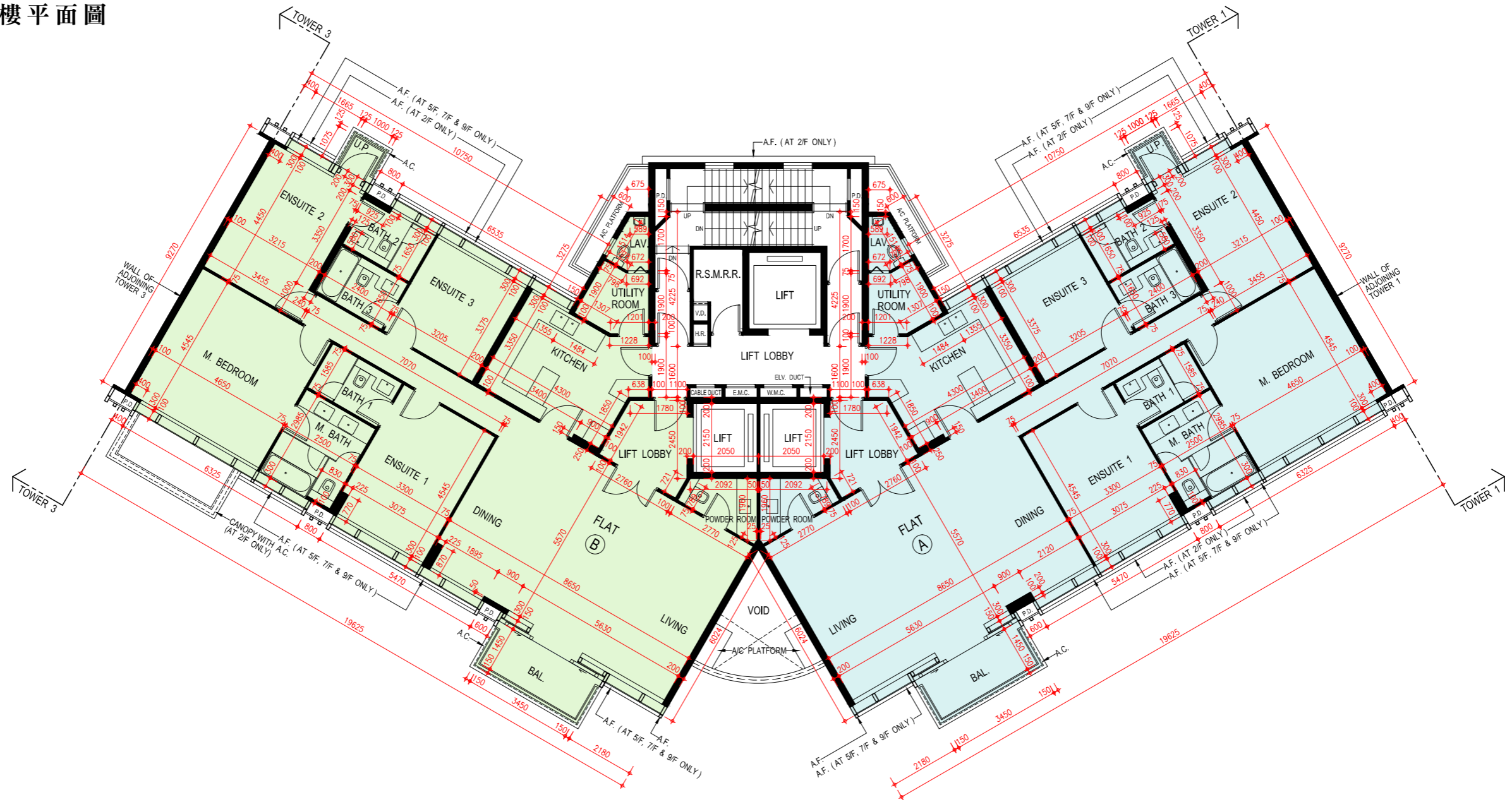
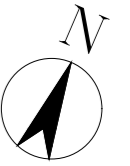

Scale: 0M/米 5M/米  
比例: 1:500



## FLOOR PLANS OF RESIDENTIAL PROPERTIES IN THE DEVELOPMENT

### 發展項目的住宅物業的樓面平面圖

#### Tower 2

#### 第2座

#### 7/F Plan

#### 7樓平面圖

	Tower 2 第2座	
Floor 樓層	7/F 7樓	
Flat 單位	A	B
The thickness of the floor slabs (excluding plaster) of each residential property (mm) 每個住宅物業的樓板(不包括灰泥)的厚度(毫米)	125, 150, 200	125, 150, 200
The floor-to-floor heights of each residential property (mm) 每個住宅物業的層與層之間的高度(毫米)	3150, 3150*	3150, 3150*

The internal areas of the residential properties on the upper floors will generally be slightly larger than those on the lower floors because of the reducing thickness of the structural walls on the upper floors.

因住宅物業的較高樓層的結構牆的厚度遞減，較高樓層的內部面積，一般比較低樓層的內部面積稍大。

#### Notes:

- The dimensions of floor plans are all structural dimensions in millimeter.
- There may be architectural features and/or exposed pipes on external walls of the residential properties. For details, please refer to the latest approved building plans.
- Common pipes exposed and/or enclosed in cladding are located at/adjacent to flat roof and/or external wall of the residential properties. For details, please refer to the latest approved building plans.
- There are ceiling bulkheads and/or sunken slab at living/dining room, bedrooms, ensuites, study rooms, utility rooms, store rooms, corridors, bathrooms, powder rooms, lavatories and kitchen of some residential units for the air-conditioning system and/or mechanical and electrical services.
- Symbols of fittings and fitments shown in the floor plans, such as bathtubs, sink, water closets, shower, sink counter etc are architectural symbols extracted from the latest approved general building plans for general indication only.
- [\*] Inclusive of the thickness of mass concrete fill on sunken slab.
- Flat B on 7/F of Tower 2 has been altered by way of minor works or exempted works under the Buildings Ordinance after the completion of the Development. The latest condition of which is shown on the relevant floor plans. The alterations are as follows:
  - Adjustments have been made to the glass partitions of Master Bathroom.

#### 備註：

- 平面圖所列之尺寸數字為以毫米標示之建築尺寸。
- 住宅物業的外牆設有建築裝飾及/或外露喉管。詳細資料請參考最新批准之建築圖則。
- 住宅物業的平台及/或外牆設有外露及/或外牆裝飾板內藏之公用喉管。詳細資料請參考最新批准的建築圖則。
- 部份住宅單位的客/飯廳、睡房、套房、書房、工作間、儲物室、走廊、浴室、客廳洗手間、洗手間及廚房有假天花及/或有跌級樓板用以裝置冷氣系統及/或機電設備。
- 樓面平面圖上所顯示的形象裝置符號，例如浴缸、洗滌盆、坐廁、花灑、洗滌盆櫃乃摘自最新的經批准的建築圖則，並只作一般性標誌。
- [\*] 包括跌級樓板上之混凝土填充層厚度。
- 第2座7樓B單位在發展項目落成後進行小型工程或獲《建築物條例》豁免的工程而有所改動。現狀請參考有關平面圖，該改動如下：
  - 主人浴室的玻璃間隔已被改動。

FLOOR PLANS OF RESIDENTIAL PROPERTIES IN THE DEVELOPMENT

發展項目的住宅物業的樓面平面圖

Tower 2

第2座

7/F Plan

7樓平面圖

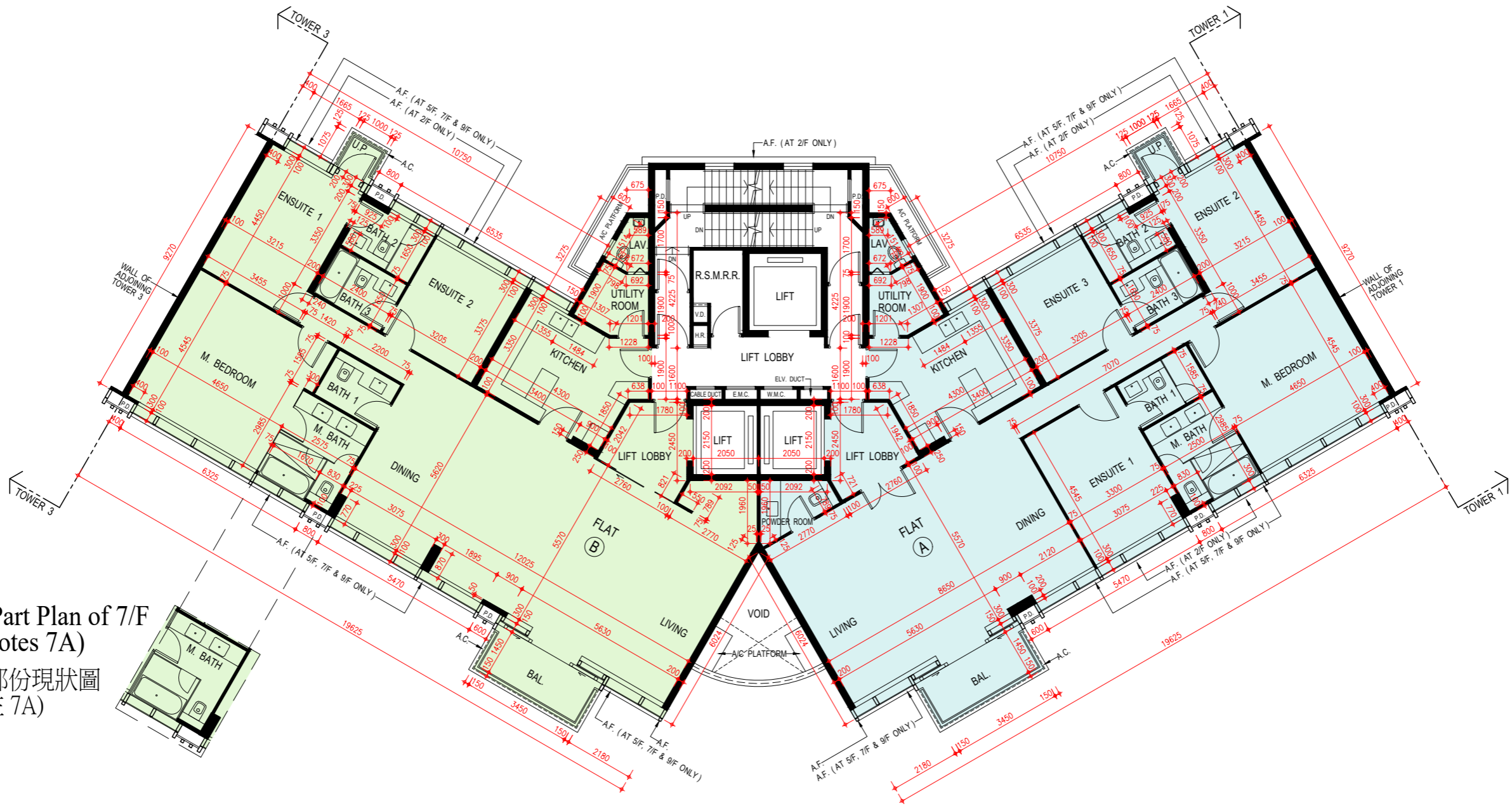
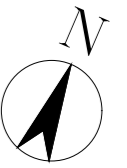

As-is Part Plan of 7/F  
(See Notes 7A)

7樓之部份現狀圖  
(見備註 7A)

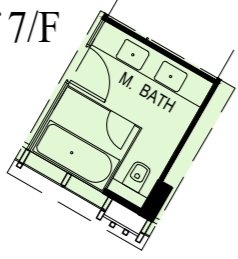

Scale: 0M/米 5M/米  
比例: 1:500

**Tower 2**

**第2座**

**8/F Plan**

**8樓平面圖**

	Tower 2 第2座	
Floor 樓層	8/F 8樓	
Flat 單位	A	B
The thickness of the floor slabs (excluding plaster) of each residential property (mm) 每個住宅物業的樓板(不包括灰泥)的厚度(毫米)	125, 150, 200	125, 150, 200
The floor-to-floor heights of each residential property (mm) 每個住宅物業的層與層之間的高度(毫米)	3150, 3150*	3150, 3150*

The internal areas of the residential properties on the upper floors will generally be slightly larger than those on the lower floors because of the reducing thickness of the structural walls on the upper floors.

因住宅物業的較高樓層的結構牆的厚度遞減，較高樓層的內部面積，一般比較低樓層的內部面積稍大。

Notes:

- The dimensions of floor plans are all structural dimensions in millimeter.
- There may be architectural features and/or exposed pipes on external walls of the residential properties. For details, please refer to the latest approved building plans.
- Common pipes exposed and/or enclosed in cladding are located at/adjacent to flat roof and/or external wall of the residential properties. For details, please refer to the latest approved building plans.
- There are ceiling bulkheads and/or sunken slab at living/dining room, bedrooms, ensuites, study rooms, utility rooms, store rooms, corridors, bathrooms, powder rooms, lavatories and kitchen of some residential units for the air-conditioning system and/or mechanical and electrical services.
- Symbols of fittings and fitments shown in the floor plans, such as bathtubs, sink, water closets, shower, sink counter etc are architectural symbols extracted from the latest approved general building plans for general indication only.
- [\*] Inclusive of the thickness of mass concrete fill on sunken slab.
- Flat B on 8/F of Tower 2 has been altered by way of minor works or exempted works under the Buildings Ordinance after the completion of the Development. The latest condition of which is shown on the relevant floor plans. The alterations are as follows:  
A. Adjustments have been made to the glass partitions of Master Bathroom.

備註：

- 平面圖所列之尺寸數字為以毫米標示之建築尺寸。
- 住宅物業的外牆設有建築裝飾及/或外露喉管。詳細資料請參考最新批准之建築圖則。
- 住宅物業的平台及/或外牆設有外露及/或外牆裝飾板內藏之公用喉管。詳細資料請參考最新批准的建築圖則。
- 部份住宅單位的客/飯廳、睡房、套房、書房、工作間、儲物室、走廊、浴室、客廳洗手間、洗手間及廚房有假天花及/或有跌級樓板用以裝置冷氣系統及/或機電設備。
- 樓面平面圖上所顯示的形象裝置符號，例如浴缸、洗滌盆、坐廁、花灑、洗滌盆櫃乃摘自最新的經批准的建築圖則，並只作一般性標誌。
- [\*] 包括跌級樓板上之混凝土填充層厚度。
- 第2座8樓B單位在發展項目落成後進行小型工程或獲《建築物條例》豁免的工程而有所改動。現狀請參考有關平面圖，該改動如下：  
A. 主人浴室的玻璃間隔已被改動。

FLOOR PLANS OF RESIDENTIAL PROPERTIES IN THE DEVELOPMENT

發展項目的住宅物業的樓面平面圖

Tower 2  
第2座

8/F Plan  
8樓平面圖

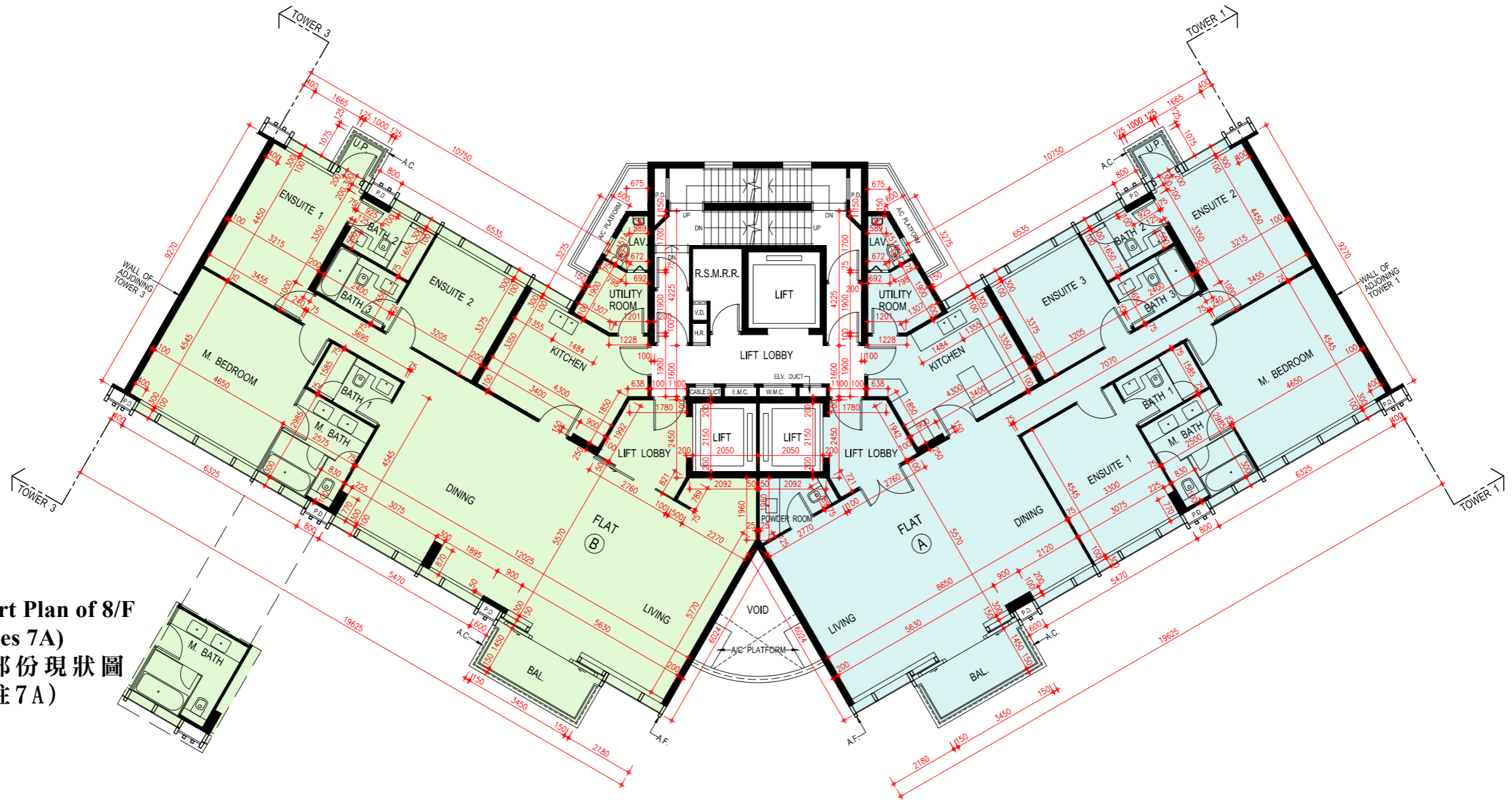
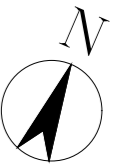

As-is Part Plan of 8/F  
(See Notes 7A)  
8樓之部份現狀圖  
(見備註7A)

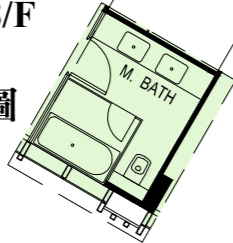

Scale: 0M/米 5M/米  
比例: 1:500



**Tower 2**

**第 2 座**

**10/F Plan**

**10 樓平面圖**

	Tower 2 第2座
Floor 樓層	10/F 10樓
Flat 單位	Spa Duplex A & Spa Duplex B
The thickness of the floor slabs (excluding plaster) of each residential property (mm) 每個住宅物業的樓板(不包括灰泥)的厚度(毫米)	125, 150, 200
The floor-to-floor heights of each residential property (mm) 每個住宅物業的層與層之間的高度(毫米)	3150, 3250, 3500, 3750*, 3850*

The internal areas of the residential properties on the upper floors will generally be slightly larger than those on the lower floors because of the reducing thickness of the structural walls on the upper floors.

因住宅物業的較高樓層的結構牆的厚度遞減，較高樓層的內部面積，一般比較低樓層的內部面積稍大。

Notes:

1. The dimensions of floor plans are all structural dimensions in millimeter.
2. There may be architectural features and/or exposed pipes on external walls of the residential properties. For details, please refer to the latest approved building plans.
3. Common pipes exposed and/or enclosed in cladding are located at/adjacent to flat roof and/or external wall of the residential properties. For details, please refer to the latest approved building plans.
4. There are ceiling bulkheads and/or sunken slab at living/dining room, bedrooms, ensuites, study rooms, utility rooms, store rooms, corridors, bathrooms, powder rooms, lavatories and kitchen of some residential units for the air-conditioning system and/or mechanical and electrical services.
5. Symbols of fittings and fitments shown in the floor plans, such as bathtubs, sink, water closets, shower, sink counter etc are architectural symbols extracted from the latest approved general building plans for general indication only.
6. [\*] Inclusive of the thickness of mass concrete fill on sunken slab.

備註：

1. 平面圖所列之尺寸數字為以毫米標示之建築尺寸。
2. 住宅物業的外牆設有建築裝飾及/或外露喉管。詳細資料請參考最新批准之建築圖則。
3. 住宅物業的平台及/或外牆設有外露及/或外牆裝飾板內藏之公用喉管。詳細資料請參考最新批准的建築圖則。
4. 部份住宅單位的客/飯廳、睡房、套房、書房、工作間、儲物室、走廊、浴室、客廳洗手間、洗手間及廚房有假天花及/或有跌級樓板用以裝置冷氣系統及/或機電設備。
5. 樓面平面圖上所顯示的形象裝置符號，例如浴缸、洗滌盆、坐廁、花灑、洗滌盆櫃乃摘自最新的經批准的建築圖則，並只作一般性標誌。
6. [\*] 包括跌級樓板上之混凝土填充層厚度。



FLOOR PLANS OF RESIDENTIAL PROPERTIES IN THE DEVELOPMENT  
 發展項目的住宅物業的樓面平面圖

Tower 2  
 第2座

10/F Plan  
 10樓平面圖

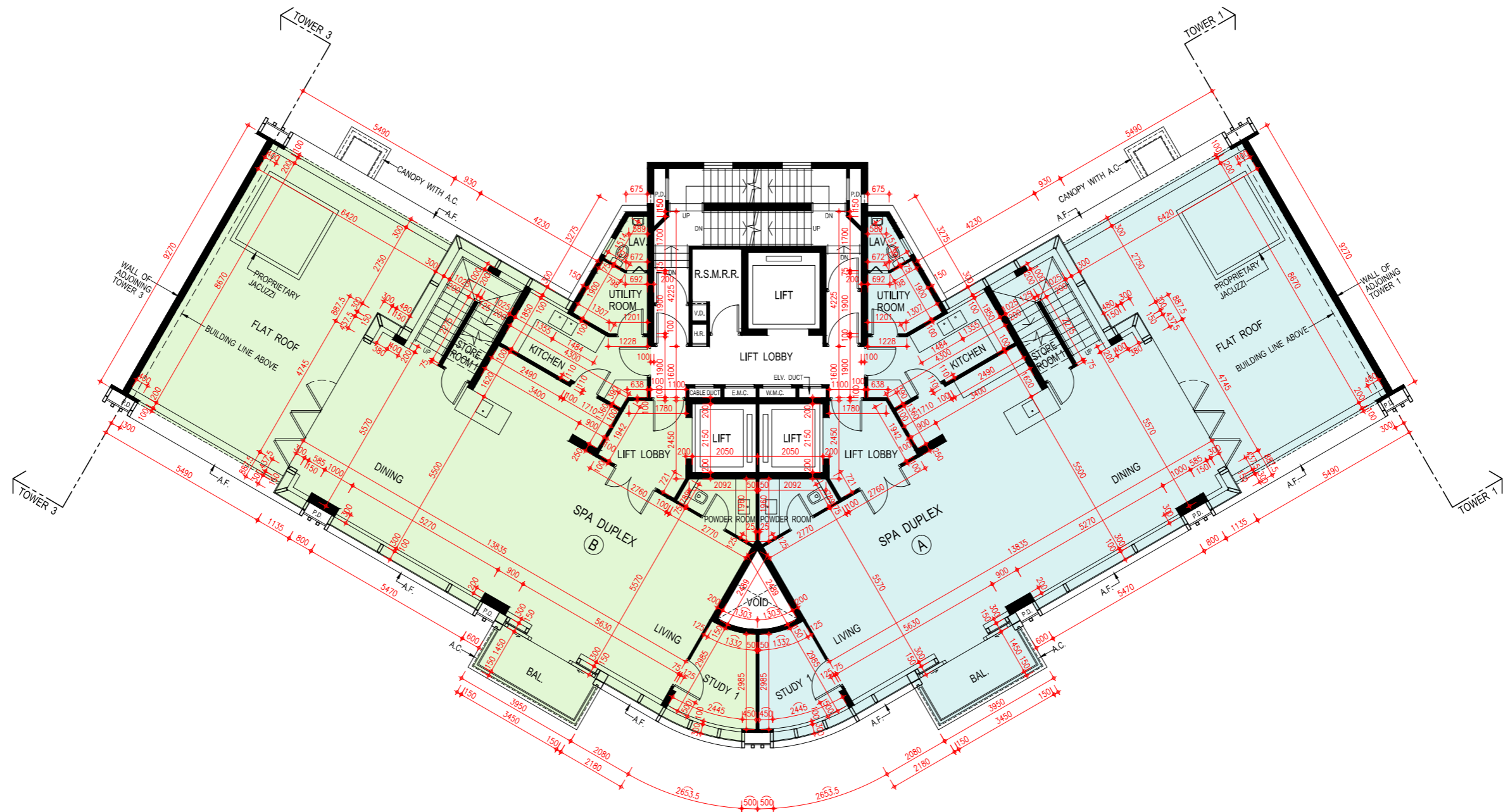
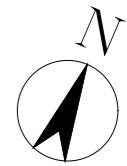

Scale: 0M/米 5M/米  
 比例: 0 5M/米

**Tower 2**

**第 2 座**

**11/F Plan**

**11 樓平面圖**

	Tower 2 第2座
Floor 樓層	11/F 11樓
Flat 單位	Spa Duplex A & Spa Duplex B
The thickness of the floor slabs (excluding plaster) of each residential property (mm) 每個住宅物業的樓板(不包括灰泥)的厚度(毫米)	125, 150, 200
The floor-to-floor heights of each residential property (mm) 每個住宅物業的層與層之間的高度(毫米)	3250, 3500*, 3600*

The internal areas of the residential properties on the upper floors will generally be slightly larger than those on the lower floors because of the reducing thickness of the structural walls on the upper floors.

因住宅物業的較高樓層的結構牆的厚度遞減，較高樓層的內部面積，一般比較低樓層的內部面積稍大。

Notes:

1. The dimensions of floor plans are all structural dimensions in millimeter.
2. There may be architectural features and/or exposed pipes on external walls of the residential properties. For details, please refer to the latest approved building plans.
3. Common pipes exposed and/or enclosed in cladding are located at/adjacent to flat roof and/or external wall of the residential properties. For details, please refer to the latest approved building plans.
4. There are ceiling bulkheads and/or sunken slab at living/dining room, bedrooms, ensuites, study rooms, utility rooms, store rooms, corridors, bathrooms, powder rooms, lavatories and kitchen of some residential units for the air-conditioning system and/or mechanical and electrical services.
5. Symbols of fittings and fitments shown in the floor plans, such as bathtubs, sink, water closets, shower, sink counter etc are architectural symbols extracted from the latest approved general building plans for general indication only.
6. [\*] Inclusive of the thickness of mass concrete fill on sunken slab.

備註：

1. 平面圖所列之尺寸數字為以毫米標示之建築尺寸。
2. 住宅物業的外牆設有建築裝飾及/或外露喉管。詳細資料請參考最新批准之建築圖則。
3. 住宅物業的平台及/或外牆設有外露及/或外牆裝飾板內藏之公用喉管。詳細資料請參考最新批准的建築圖則。
4. 部份住宅單位的客/飯廳、睡房、套房、書房、工作間、儲物室、走廊、浴室、客廳洗手間、洗手間及廚房有假天花及/或有跌級樓板用以裝置冷氣系統及/或機電設備。
5. 樓面平面圖上所顯示的形象裝置符號，例如浴缸、洗滌盆、坐廁、花灑、洗滌盆櫃乃摘自最新的經批准的建築圖則，並只作一般性標誌。
6. [\*] 包括跌級樓板上之混凝土填充層厚度。

FLOOR PLANS OF RESIDENTIAL PROPERTIES IN THE DEVELOPMENT  
發展項目的住宅物業的樓面平面圖

Tower 2  
第2座

11/F Plan  
11樓平面圖

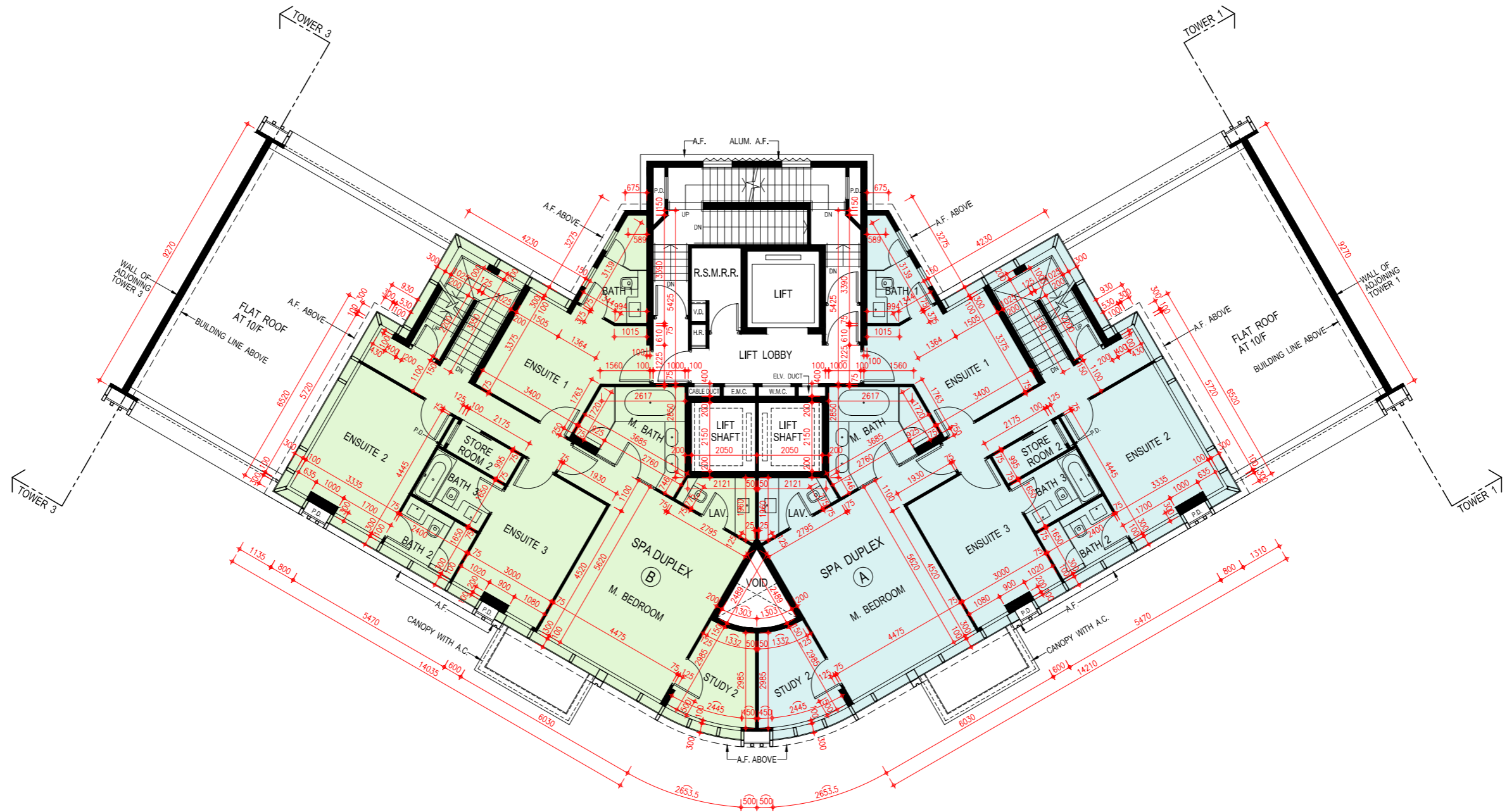
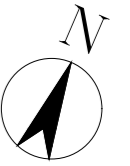

Scale: 0M/米 5M/米  
比例: 5M/米

**Tower 2**

**第 2 座**

**Roof Floor Plan**

**天台平面圖**

	Tower 2 第2座
Floor 樓層	Roof 天台
Flat 單位	Spa Duplex A & Spa Duplex B
The thickness of the floor slabs (excluding plaster) of each residential property (mm) 每個住宅物業的樓板(不包括灰泥)的厚度(毫米)	Not Applicable 不適用
The floor-to-floor heights of each residential property (mm) 每個住宅物業的層與層之間的高度(毫米)	Not Applicable 不適用

The internal areas of the residential properties on the upper floors will generally be slightly larger than those on the lower floors because of the reducing thickness of the structural walls on the upper floors.

因住宅物業的較高樓層的結構牆的厚度遞減，較高樓層的內部面積，一般比較低樓層的內部面積稍大。

Notes:

1. The dimensions of floor plans are all structural dimensions in millimeter.
2. There may be architectural features and/or exposed pipes on external walls of the residential properties. For details, please refer to the latest approved building plans.
3. Common pipes exposed and/or enclosed in cladding are located at/adjacent to flat roof and/or external wall of the residential properties. For details, please refer to the latest approved building plans.
4. There are ceiling bulkheads and/or sunken slab at living/dining room, bedrooms, ensuites, study rooms, utility rooms, store rooms, corridors, bathrooms, powder rooms, lavatories and kitchen of some residential units for the air-conditioning system and/or mechanical and electrical services.
5. Symbols of fittings and fitments shown in the floor plans, such as bathtubs, sink, water closets, shower, sink counter etc are architectural symbols extracted from the latest approved general building plans for general indication only.
6. [\*] Inclusive of the thickness of mass concrete fill on sunken slab.

備註：

1. 平面圖所列之尺寸數字為以毫米標示之建築尺寸。
2. 住宅物業的外牆設有建築裝飾及/或外露喉管。詳細資料請參考最新批准之建築圖則。
3. 住宅物業的平台及/或外牆設有外露及/或外牆裝飾板內藏之公用喉管。詳細資料請參考最新批准的建築圖則。
4. 部份住宅單位的客/飯廳、睡房、套房、書房、工作間、儲物室、走廊、浴室、客廳洗手間、洗手間及廚房有假天花及/或有跌級樓板用以裝置冷氣系統及/或機電設備。
5. 樓面平面圖上所顯示的形象裝置符號，例如浴缸、洗滌盆、坐廁、花灑、洗滌盆櫃乃摘自最新的經批准的建築圖則，並只作一般性標誌。
6. [\*] 包括跌級樓板上之混凝土填充層厚度。

Tower 2  
第2座

Roof Floor Plan  
天台平面圖

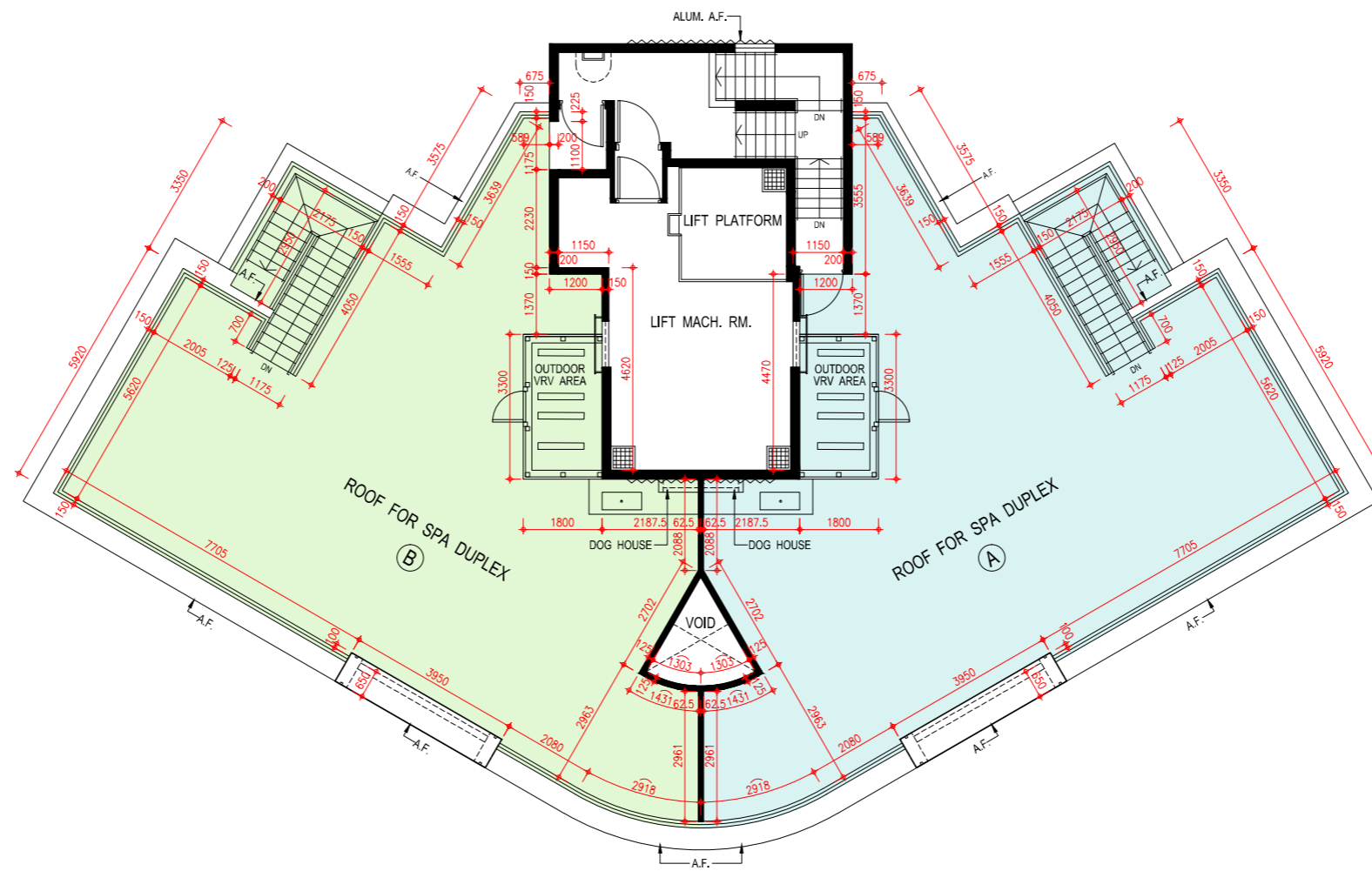
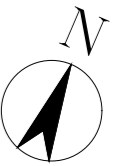



## FLOOR PLANS OF RESIDENTIAL PROPERTIES IN THE DEVELOPMENT

### 發展項目的住宅物業的樓面平面圖

#### Tower 3

#### 第3座

#### G/F Plan

#### 地下平面圖

	Tower 3 第3座	
Floor 樓層	G/F 地下	
Flat 單位	Garden Duplex	• Garden Apartment
The thickness of the floor slabs (excluding plaster) of each residential property (mm) 每個住宅物業的樓板(不包括灰泥)的厚度(毫米)	125, 150, 200	125, 150, 175
The floor-to-floor heights of each residential property (mm) 每個住宅物業的層與層之間的高度(毫米)	3250, 3450, 3575, 3800*, 6250, 6350, 6600	3100, 3150, 3200, 3250, 3450, 3450*, 3500*, 3550*, 3600*, 3800*

The internal areas of the residential properties on the upper floors will generally be slightly larger than those on the lower floors because of the reducing thickness of the structural walls on the upper floors.

因住宅物業的較高樓層的結構牆的厚度遞減，較高樓層的內部面積，一般比較低樓層的內部面積稍大。

#### Notes:

- The dimensions of floor plans are all structural dimensions in millimeter.
- There may be architectural features and/or exposed pipes on external walls of the residential properties. For details, please refer to the latest approved building plans.
- Common pipes exposed and/or enclosed in cladding are located at/adjacent to flat roof and/or external wall of the residential properties. For details, please refer to the latest approved building plans.
- There are ceiling bulkheads and/or sunken slab at living/dining room, bedrooms, ensuites, study rooms, utility rooms, store rooms, corridors, bathrooms, powder rooms, lavatories and kitchen of some residential units for the air-conditioning system and/or mechanical and electrical services.
- Symbols of fittings and fitments shown in the floor plans, such as bathtubs, sink, water closets, shower, sink counter etc are architectural symbols extracted from the latest approved general building plans for general indication only.
- “Terrace Apartment”, “Garden Apartment” and “Courtyard Penthouse” are names for marketing purposes only and will not appear in any Deed of Mutual Covenant, the Preliminary Agreement for Sale and Purchase, Agreement for Sale and Purchase, Assignment, or any other title deeds and documents relating to the Development. The names as appearing on the approved building plans are: Flat A on 1/F of Tower 1 for Terrace Apartment on 1/F of Tower 1; Flat B on G/F of Tower 2 for Garden Apartment on G/F of Tower 2; Flat B on G/F of Tower 3 for Garden Apartment on G/F of Tower 3; Flat A on G/F of Tower 7 for Garden Apartment on G/F of Tower 7; Penthouse on 11/F of Tower 7 for Courtyard Penthouse on 11/F of Tower 7; Flat B on G/F of Tower 8 for Garden Apartment on G/F of Tower 8; Penthouse on 11/F of Tower 8 for Courtyard Penthouse on 11/F of Tower 8.
- [\*] Inclusive of the thickness of mass concrete fill on sunken slab.

#### 備註：

- 平面圖所列之尺寸數字為以毫米標示之建築尺寸。
- 住宅物業的外牆設有建築裝飾及/或外露喉管。詳細資料請參考最新批准之建築圖則。
- 住宅物業的平台及/或外牆設有外露及/或外牆裝飾板內藏之公用喉管。詳細資料請參考最新批准的建築圖則。
- 部份住宅單位的客/飯廳、睡房、套房、書房、工作間、儲物室、走廊、浴室、客廳洗手間、洗手間及廚房有假天花及/或有跌級樓板用以裝置冷氣系統及/或機電設備。
- 樓面平面圖上所顯示的形象裝置符號，例如浴缸、洗滌盆、坐廁、花灑、洗滌盆櫃乃摘自最新的經批准的建築圖則，並只作一般性標誌。
- 「Terrace Apartment」、「Garden Apartment」及「Courtyard Penthouse」僅為市場推廣之用的名稱，並不會於關於發展項目的任何公契、臨時買賣合約、買賣合約、轉讓契及契據出現。經批准的建築圖則上顯示的名稱為：第1座1樓A單位（即第1座1樓Terrace Apartment）；第2座地下B單位（即第2座地下Garden Apartment）；第3座地下B單位（即第3座地下Garden Apartment）；第7座地下A單位（即第7座地下Garden Apartment）；第7座11樓Penthouse（即第7座11樓Courtyard Penthouse）；第8座地下B單位（即第8座地下Garden Apartment）；第8座11樓Penthouse（即第8座11樓Courtyard Penthouse）。
- [\*] 包括跌級樓板上之混凝土填充層厚度。

FLOOR PLANS OF RESIDENTIAL PROPERTIES IN THE DEVELOPMENT

發展項目的住宅物業的樓面平面圖

Tower 3  
第3座

G/F Plan  
地下平面圖

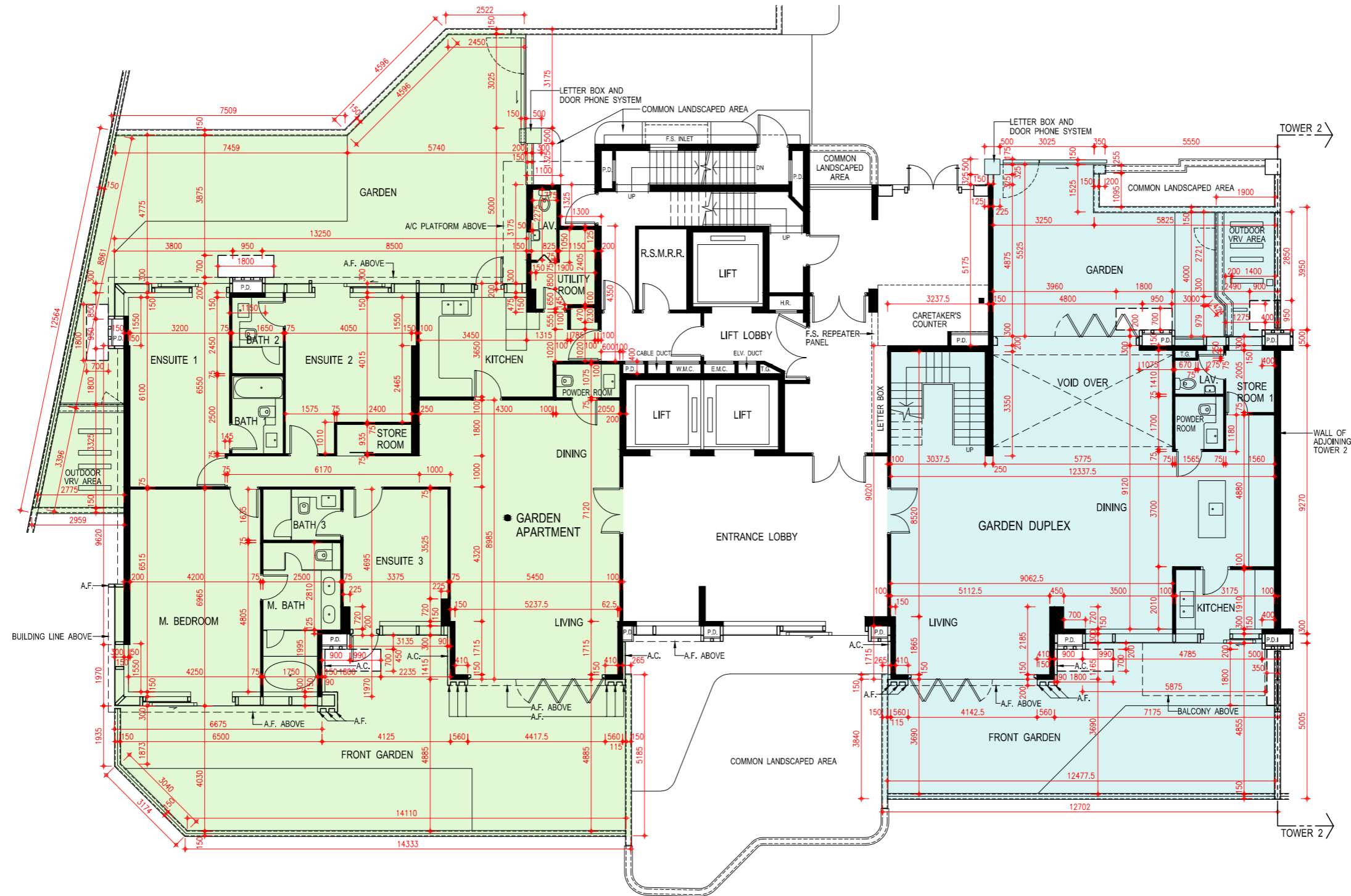

Scale: 0M/米 5M/米  
比例: 1:500

**Tower 3**

**第3座**

**1/F Plan**

**1樓平面圖**

	Tower 3 第3座	
Floor 樓層	1/F 1樓	
Flat 單位	Garden Duplex	B
The thickness of the floor slabs (excluding plaster) of each residential property (mm) 每個住宅物業的樓板(不包括灰泥)的厚度(毫米)	125, 150, 175	125, 150, 175
The floor-to-floor heights of each residential property (mm) 每個住宅物業的層與層之間的高度(毫米)	2800, 2900, 3125, 3150	2800, 2900, 3050*, 3150, 3150*, 3225, 3250*, 3275, 3400*, 3500*

The internal areas of the residential properties on the upper floors will generally be slightly larger than those on the lower floors because of the reducing thickness of the structural walls on the upper floors.

因住宅物業的較高樓層的結構牆的厚度遞減，較高樓層的內部面積，一般比較低樓層的內部面積稍大。

Notes:

1. The dimensions of floor plans are all structural dimensions in millimeter.
2. There may be architectural features and/or exposed pipes on external walls of the residential properties. For details, please refer to the latest approved building plans.
3. Common pipes exposed and/or enclosed in cladding are located at/adjacent to flat roof and/or external wall of the residential properties. For details, please refer to the latest approved building plans.
4. There are ceiling bulkheads and/or sunken slab at living/dining room, bedrooms, ensuites, study rooms, utility rooms, store rooms, corridors, bathrooms, powder rooms, lavatories and kitchen of some residential units for the air-conditioning system and/or mechanical and electrical services.
5. Symbols of fittings and fitments shown in the floor plans, such as bathtubs, sink, water closets, shower, sink counter etc are architectural symbols extracted from the latest approved general building plans for general indication only.
6. [\*] Inclusive of the thickness of mass concrete fill on sunken slab.

備註：

1. 平面圖所列之尺寸數字為以毫米標示之建築尺寸。
2. 住宅物業的外牆設有建築裝飾及/或外露喉管。詳細資料請參考最新批准之建築圖則。
3. 住宅物業的平台及/或外牆設有外露及/或外牆裝飾板內藏之公用喉管。詳細資料請參考最新批准的建築圖則。
4. 部份住宅單位的客/飯廳、睡房、套房、書房、工作間、儲物室、走廊、浴室、客廳洗手間、洗手間及廚房有假天花及/或有跌級樓板用以裝置冷氣系統及/或機電設備。
5. 樓面平面圖上所顯示的形象裝置符號，例如浴缸、洗滌盆、坐廁、花灑、洗滌盆櫃乃摘自最新的經批准的建築圖則，並只作一般性標誌。
6. [\*] 包括跌級樓板上之混凝土填充層厚度。

FLOOR PLANS OF RESIDENTIAL PROPERTIES IN THE DEVELOPMENT  
發展項目的住宅物業的樓面平面圖

Tower 3  
第3座

1/F Plan  
1樓平面圖

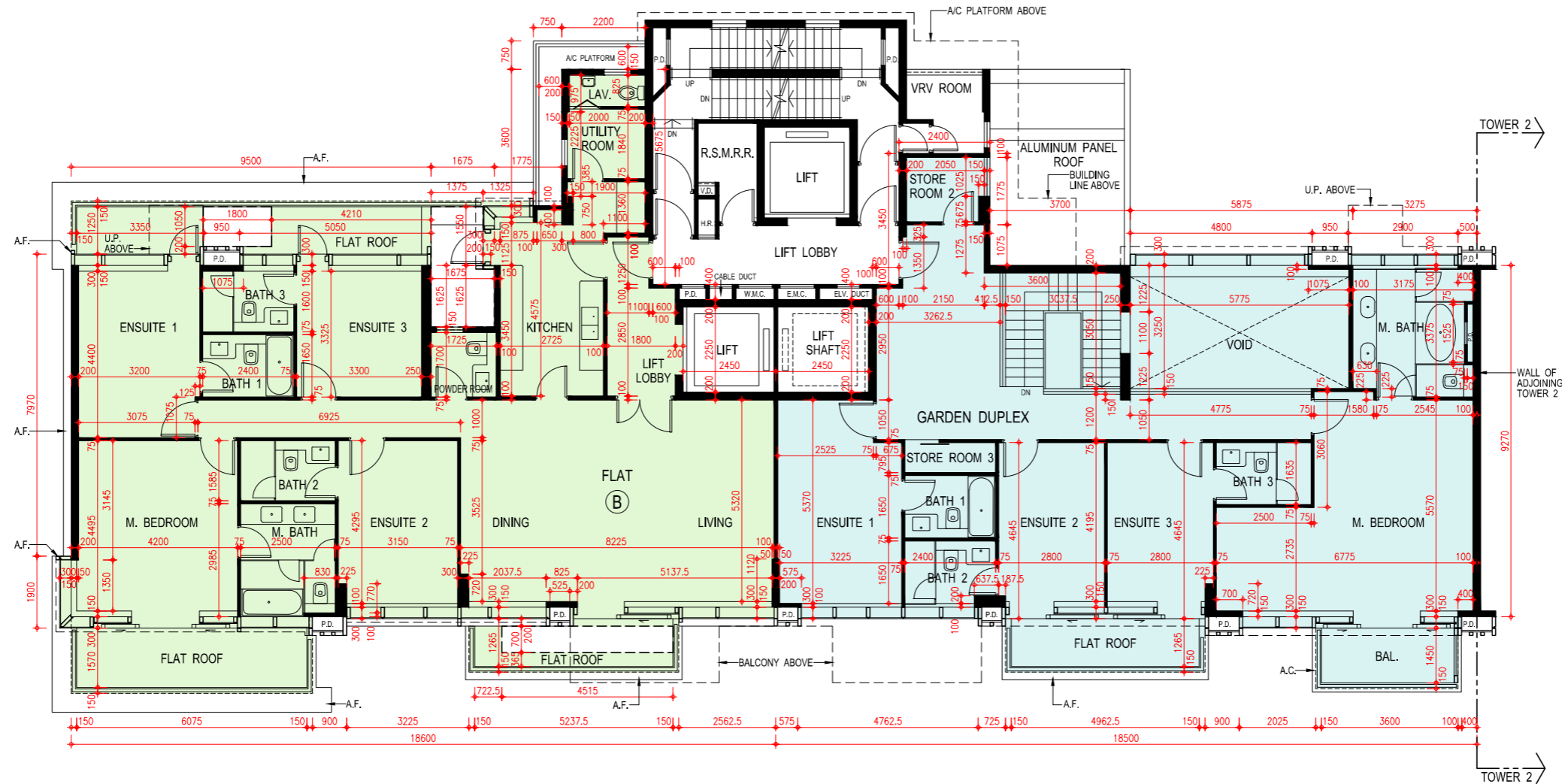

Scale: 0M/米 5M/米  
比例: 5M/米

**Tower 3**

**第3座**

**2/F - 10/F Plan**

**2樓至10樓平面圖**

Floor 樓層	Tower 3 第3座			
	2/F-9/F 2樓至9樓		10/F 10樓	
Flat 單位	A	B	A	B
The thickness of the floor slabs (excluding plaster) of each residential property (mm) 每個住宅物業的樓板(不包括灰泥)的厚度(毫米)	125, 150, 175	125, 150, 175	125, 150, 175	125, 150, 175
The floor-to-floor heights of each residential property (mm) 每個住宅物業的層與層之間的高度(毫米)	3150, 3150*	3150, 3150*	3150*, 3250*, 3400*, 3475, 3500, 3500*, 3600*, 3750*, 3850*	3050, 3200, 3250, 3300*, 3450*, 3500, 3500*, 3550*, 3750*, 3850*

The internal areas of the residential properties on the upper floors will generally be slightly larger than those on the lower floors because of the reducing thickness of the structural walls on the upper floors.

因住宅物業的較高樓層的結構牆的厚度遞減，較高樓層的內部面積，一般比較低樓層的內部面積稍大。

Notes:

1. The dimensions of floor plans are all structural dimensions in millimeter.
2. There may be architectural features and/or exposed pipes on external walls of the residential properties. For details, please refer to the latest approved building plans.
3. Common pipes exposed and/or enclosed in cladding are located at/adjacent to flat roof and/or external wall of the residential properties. For details, please refer to the latest approved building plans.
4. There are ceiling bulkheads and/or sunken slab at living/dining room, bedrooms, ensuites, study rooms, utility rooms, store rooms, corridors, bathrooms, powder rooms, lavatories and kitchen of some residential units for the air-conditioning system and/or mechanical and electrical services.
5. Symbols of fittings and fitments shown in the floor plans, such as bathtubs, sink, water closets, shower, sink counter etc are architectural symbols extracted from the latest approved general building plans for general indication only.
6. 4/F is omitted.
7. [\*] Inclusive of the thickness of mass concrete fill on sunken slab.

備註：

1. 平面圖所列之尺寸數字為以毫米標示之建築尺寸。
2. 住宅物業的外牆設有建築裝飾及/或外露喉管。詳細資料請參考最新批准之建築圖則。
3. 住宅物業的平台及/或外牆設有外露及/或外牆裝飾板內藏之公用喉管。詳細資料請參考最新批准的建築圖則。
4. 部份住宅單位的客/飯廳、睡房、套房、書房、工作間、儲物室、走廊、浴室、客廳洗手間、洗手間及廚房有假天花及/或有跌級樓板用以裝置冷氣系統及/或機電設備。
5. 樓面平面圖上所顯示的形象裝置符號，例如浴缸、洗滌盆、坐廁、花灑、洗滌盆櫃乃摘自最新的經批准的建築圖則，並只作一般性標誌。
6. 不設4樓。
7. [\*] 包括跌級樓板上之混凝土填充層厚度。



FLOOR PLANS OF RESIDENTIAL PROPERTIES IN THE DEVELOPMENT

發展項目的住宅物業的樓面平面圖

Tower 3

第3座

2/F - 10/F Plan

2樓至10樓平面圖

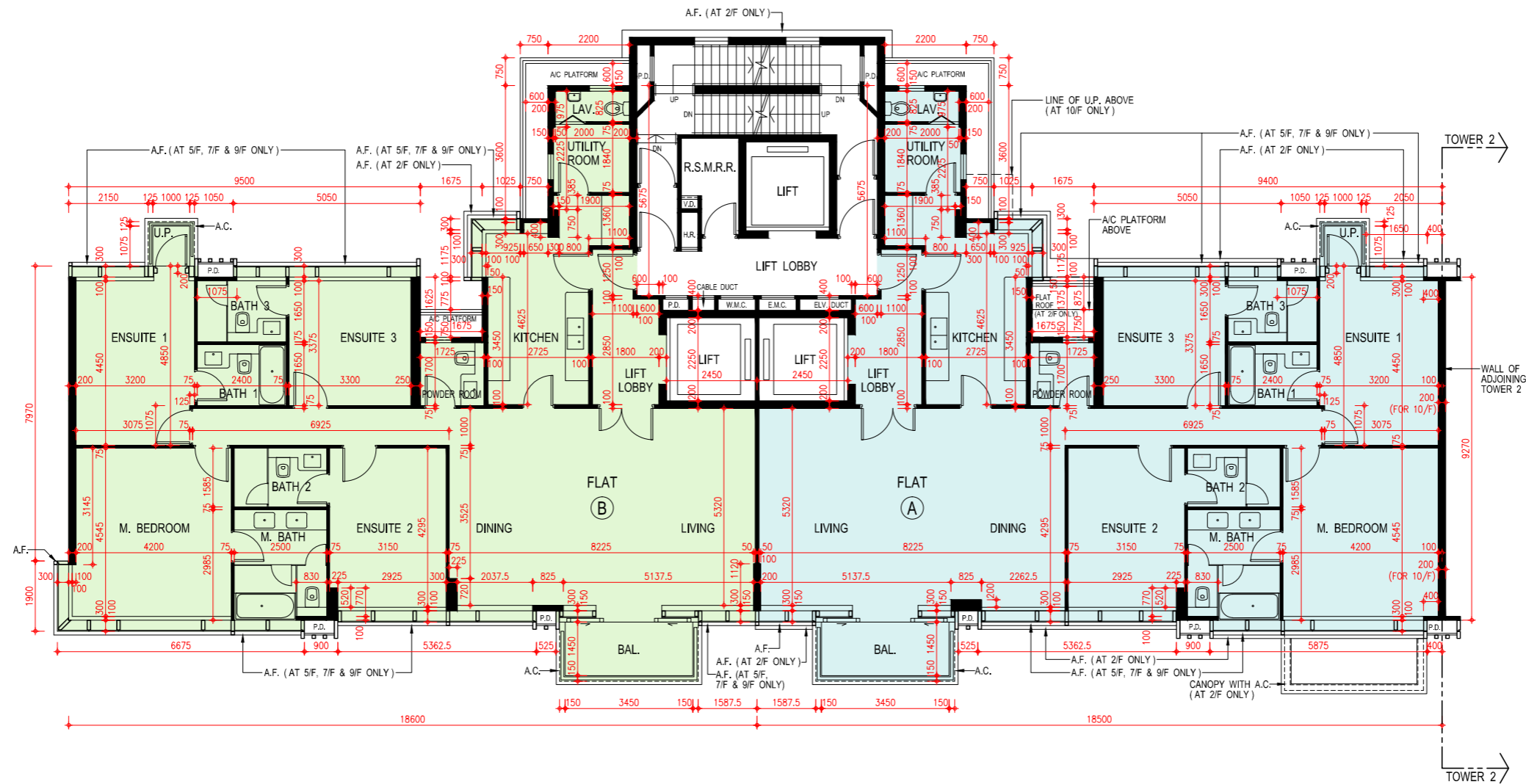

Scale: 0M/米 5M/米  
比例: 1:500

**Tower 3**

**第3座**

**11/F Plan**

**11樓平面圖**

	Tower 3 第3座
Floor 樓層	11/F 11樓
Flat 單位	Sky Pool Penthouse
The thickness of the floor slabs (excluding plaster) of each residential property (mm) 每個住宅物業的樓板(不包括灰泥)的厚度(毫米)	150, 175
The floor-to-floor heights of each residential property (mm) 每個住宅物業的層與層之間的高度(毫米)	3475, 3500, 3750*, 3850*

The internal areas of the residential properties on the upper floors will generally be slightly larger than those on the lower floors because of the reducing thickness of the structural walls on the upper floors.

因住宅物業的較高樓層的結構牆的厚度遞減，較高樓層的內部面積，一般比較低樓層的內部面積稍大。

Notes:

1. The dimensions of floor plans are all structural dimensions in millimeter.
2. There may be architectural features and/or exposed pipes on external walls of the residential properties. For details, please refer to the latest approved building plans.
3. Common pipes exposed and/or enclosed in cladding are located at/adjacent to flat roof and/or external wall of the residential properties. For details, please refer to the latest approved building plans.
4. There are ceiling bulkheads and/or sunken slab at living/dining room, bedrooms, ensuites, study rooms, utility rooms, store rooms, corridors, bathrooms, powder rooms, lavatories and kitchen of some residential units for the air-conditioning system and/or mechanical and electrical services.
5. Symbols of fittings and fitments shown in the floor plans, such as bathtubs, sink, water closets, shower, sink counter etc are architectural symbols extracted from the latest approved general building plans for general indication only.
6. [\*] Inclusive of the thickness of mass concrete fill on sunken slab.

備註：

1. 平面圖所列之尺寸數字為以毫米標示之建築尺寸。
2. 住宅物業的外牆設有建築裝飾及/或外露喉管。詳細資料請參考最新批准之建築圖則。
3. 住宅物業的平台及/或外牆設有外露及/或外牆裝飾板內藏之公用喉管。詳細資料請參考最新批准的建築圖則。
4. 部份住宅單位的客/飯廳、睡房、套房、書房、工作間、儲物室、走廊、浴室、客廳洗手間、洗手間及廚房有假天花及/或有跌級樓板用以裝置冷氣系統及/或機電設備。
5. 樓面平面圖上所顯示的形象裝置符號，例如浴缸、洗滌盆、坐廁、花灑、洗滌盆櫃乃摘自最新的經批准的建築圖則，並只作一般性標誌。
6. [\*] 包括跌級樓板上之混凝土填充層厚度。

Tower 3

第3座

11/F Plan

11樓平面圖

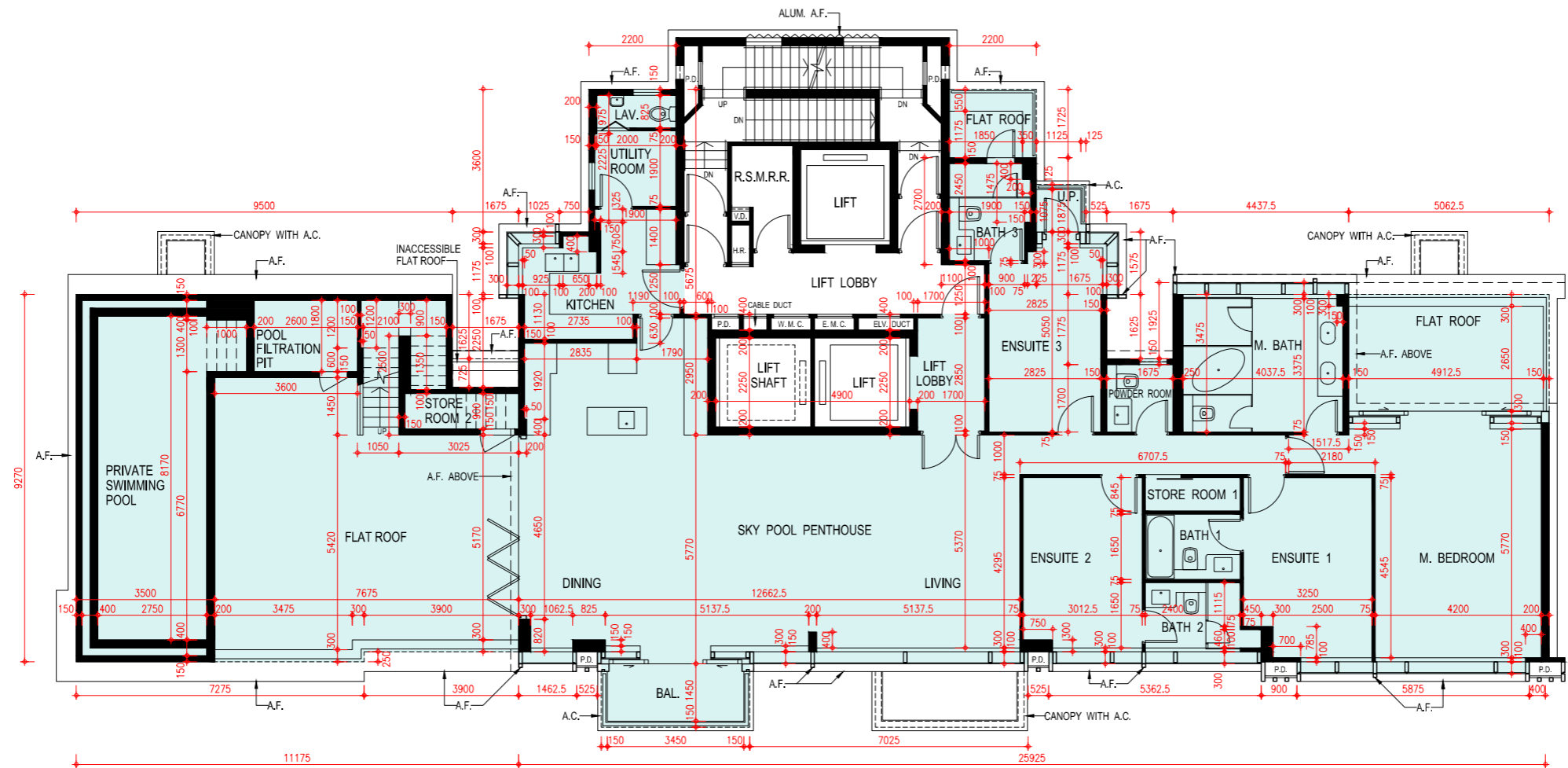

**Tower 3**

**第3座**

**Roof Floor Plan**

**天台平面圖**

	Tower 3 第3座
Floor 樓層	Roof 天台
Flat 單位	Sky Pool Penthouse
The thickness of the floor slabs (excluding plaster) of each residential property (mm) 每個住宅物業的樓板(不包括灰泥)的厚度(毫米)	Not Applicable 不適用
The floor-to-floor heights of each residential property (mm) 每個住宅物業的層與層之間的高度(毫米)	Not Applicable 不適用

The internal areas of the residential properties on the upper floors will generally be slightly larger than those on the lower floors because of the reducing thickness of the structural walls on the upper floors.

因住宅物業的較高樓層的結構牆的厚度遞減，較高樓層的內部面積，一般比較低樓層的內部面積稍大。

Notes:

1. The dimensions of floor plans are all structural dimensions in millimeter.
2. There may be architectural features and/or exposed pipes on external walls of the residential properties. For details, please refer to the latest approved building plans.
3. Common pipes exposed and/or enclosed in cladding are located at/adjacent to flat roof and/or external wall of the residential properties. For details, please refer to the latest approved building plans.
4. There are ceiling bulkheads and/or sunken slab at living/dining room, bedrooms, ensuites, study rooms, utility rooms, store rooms, corridors, bathrooms, powder rooms, lavatories and kitchen of some residential units for the air-conditioning system and/or mechanical and electrical services.
5. Symbols of fittings and fitments shown in the floor plans, such as bathtubs, sink, water closets, shower, sink counter etc are architectural symbols extracted from the latest approved general building plans for general indication only.

備註：

1. 平面圖所列之尺寸數字為以毫米標示之建築尺寸。
2. 住宅物業的外牆設有建築裝飾及/或外露喉管。詳細資料請參考最新批准之建築圖則。
3. 住宅物業的平台及/或外牆設有外露及/或外牆裝飾板內藏之公用喉管。詳細資料請參考最新批准的建築圖則。
4. 部份住宅單位的客/飯廳、睡房、套房、書房、工作間、儲物室、走廊、浴室、客廳洗手間、洗手間及廚房有假天花及/或有跌級樓板用以裝置冷氣系統及/或機電設備。
5. 樓面平面圖上所顯示的形象裝置符號，例如浴缸、洗滌盆、坐廁、花灑、洗滌盆櫃乃摘自最新的經批准的建築圖則，並只作一般性標誌。





**Tower 5**

**第5座**

**1/F Plan**

**1樓平面圖**

	Tower 5 第5座	
Floor 樓層	1/F 1樓	
Flat 單位	A	B
The thickness of the floor slabs (excluding plaster) of each residential property (mm) 每個住宅物業的樓板(不包括灰泥)的厚度(毫米)	125, 150	125, 150
The floor-to-floor heights of each residential property (mm) 每個住宅物業的層與層之間的高度(毫米)	3150, 3150*	3150, 3150*

The internal areas of the residential properties on the upper floors will generally be slightly larger than those on the lower floors because of the reducing thickness of the structural walls on the upper floors.

因住宅物業的較高樓層的結構牆的厚度遞減，較高樓層的內部面積，一般比較低樓層的內部面積稍大。

Notes:

1. The dimensions of floor plans are all structural dimensions in millimeter.
2. There may be architectural features and/or exposed pipes on external walls of the residential properties. For details, please refer to the latest approved building plans.
3. Common pipes exposed and/or enclosed in cladding are located at/adjacent to flat roof and/or external wall of the residential properties. For details, please refer to the latest approved building plans.
4. There are ceiling bulkheads and/or sunken slab at living/dining room, bedrooms, ensuites, study rooms, utility rooms, store rooms, corridors, bathrooms, powder rooms, lavatories and kitchen of some residential units for the air-conditioning system and/or mechanical and electrical services.
5. Symbols of fittings and fitments shown in the floor plans, such as bathtubs, sink, water closets, shower, sink counter etc are architectural symbols extracted from the latest approved general building plans for general indication only.
6. [\*] Inclusive of the thickness of mass concrete fill on sunken slab.

備註：

1. 平面圖所列之尺寸數字為以毫米標示之建築尺寸。
2. 住宅物業的外牆設有建築裝飾及/或外露喉管。詳細資料請參考最新批准之建築圖則。
3. 住宅物業的平台及/或外牆設有外露及/或外牆裝飾板內藏之公用喉管。詳細資料請參考最新批准的建築圖則。
4. 部份住宅單位的客/飯廳、睡房、套房、書房、工作間、儲物室、走廊、浴室、客廳洗手間、洗手間及廚房有假天花及/或有跌級樓板用以裝置冷氣系統及/或機電設備。
5. 樓面平面圖上所顯示的形象裝置符號，例如浴缸、洗滌盆、坐廁、花灑、洗滌盆櫃乃摘自最新的經批准的建築圖則，並只作一般性標誌。
6. [\*] 包括跌級樓板上之混凝土填充層厚度。

FLOOR PLANS OF RESIDENTIAL PROPERTIES IN THE DEVELOPMENT  
 發展項目的住宅物業的樓面平面圖

Tower 5  
 第5座

1/F Plan  
 1樓平面圖

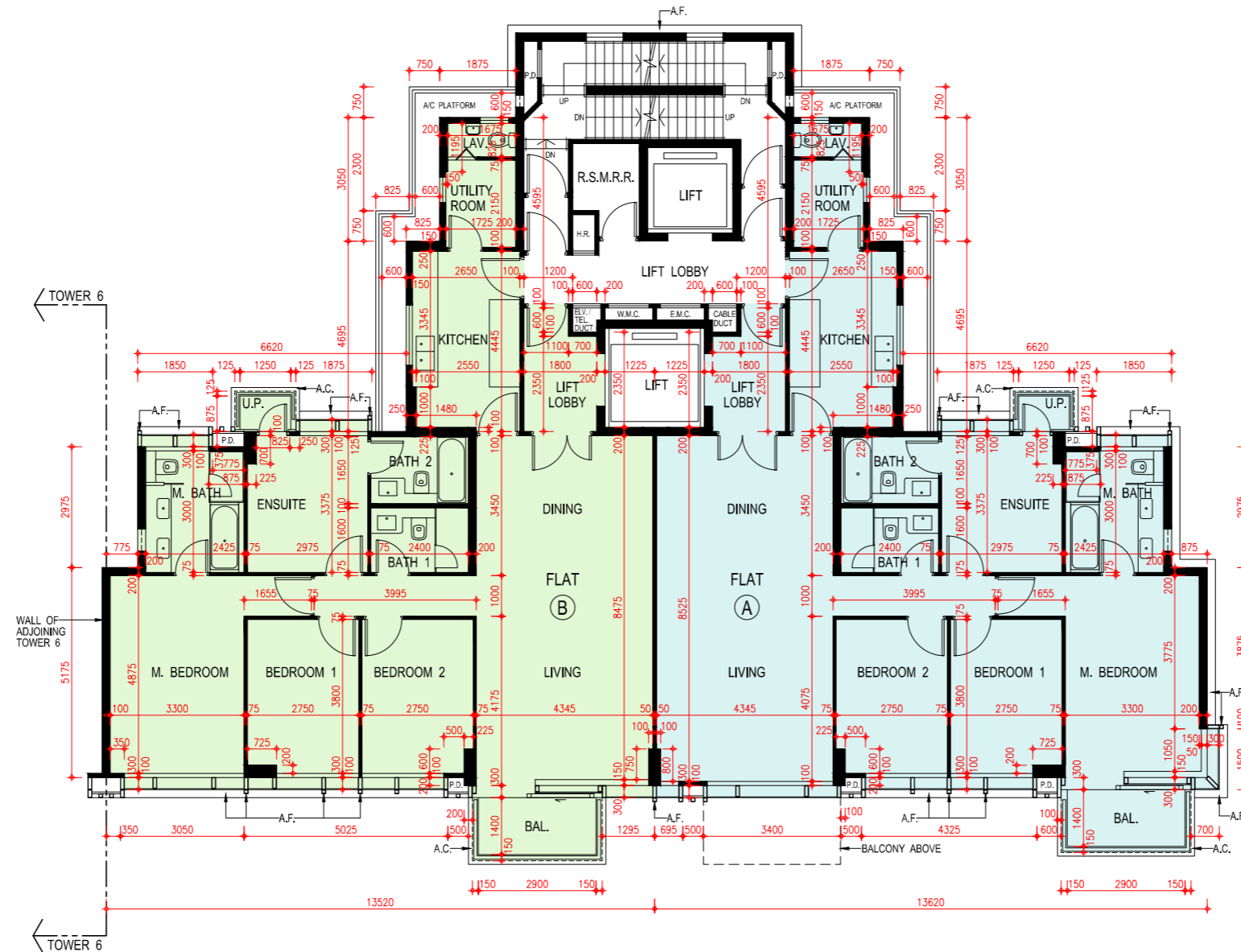
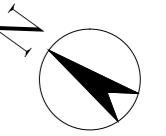

Scale: 0M/米 5M/米  
 比例: 5M/米

**Tower 5**

**第5座**

**2/F - 10/F Plan**

**2樓至10樓平面圖**

Floor 樓層	Tower 5 第5座			
	2/F-9/F 2樓至9樓		10/F 10樓	
	A	B	A	B
Flat 單位				
The thickness of the floor slabs (excluding plaster) of each residential property (mm) 每個住宅物業的樓板(不包括灰泥)的厚度(毫米)	125, 150	125, 150	125, 150, 175	125, 150, 175
The floor-to-floor heights of each residential property (mm) 每個住宅物業的層與層之間的高度(毫米)	3150, 3150*	3150, 3150*	3150, 3200, 3250, 3450*, 3500, 3550*, 3600*, 3700*, 3750*, 3850*	3050, 3150, 3250, 3300*, 3400*, 3500, 3500*, 3600*, 3700*, 3750*, 3850*

The internal areas of the residential properties on the upper floors will generally be slightly larger than those on the lower floors because of the reducing thickness of the structural walls on the upper floors.

因住宅物業的較高樓層的結構牆的厚度遞減，較高樓層的內部面積，一般比較低樓層的內部面積稍大。

Notes:

1. The dimensions of floor plans are all structural dimensions in millimeter.
2. There may be architectural features and/or exposed pipes on external walls of the residential properties. For details, please refer to the latest approved building plans.
3. Common pipes exposed and/or enclosed in cladding are located at/adjacent to flat roof and/or external wall of the residential properties. For details, please refer to the latest approved building plans.
4. There are ceiling bulkheads and/or sunken slab at living/dining room, bedrooms, ensuites, study rooms, utility rooms, store rooms, corridors, bathrooms, powder rooms, lavatories and kitchen of some residential units for the air-conditioning system and/or mechanical and electrical services.
5. Symbols of fittings and fitments shown in the floor plans, such as bathtubs, sink, water closets, shower, sink counter etc are architectural symbols extracted from the latest approved general building plans for general indication only.
6. 4/F is omitted.
7. [\*] Inclusive of the thickness of mass concrete fill on sunken slab.

備註：

1. 平面圖所列之尺寸數字為以毫米標示之建築尺寸。
2. 住宅物業的外牆設有建築裝飾及/或外露喉管。詳細資料請參考最新批准之建築圖則。
3. 住宅物業的平台及/或外牆設有外露及/或外牆裝飾板內藏之公用喉管。詳細資料請參考最新批准的建築圖則。
4. 部份住宅單位的客/飯廳、睡房、套房、書房、工作間、儲物室、走廊、浴室、客廳洗手間、洗手間及廚房有假天花及/或有跌級樓板用以裝置冷氣系統及/或機電設備。
5. 樓面平面圖上所顯示的形象裝置符號，例如浴缸、洗滌盆、坐廁、花灑、洗滌盆櫃乃摘自最新的經批准的建築圖則，並只作一般性標誌。
6. 不設4樓。
7. [\*] 包括跌級樓板上之混凝土填充層厚度。

FLOOR PLANS OF RESIDENTIAL PROPERTIES IN THE DEVELOPMENT  
發展項目的住宅物業的樓面平面圖

Tower 5  
第5座

2/F - 10/F Plan  
2樓至10樓平面圖

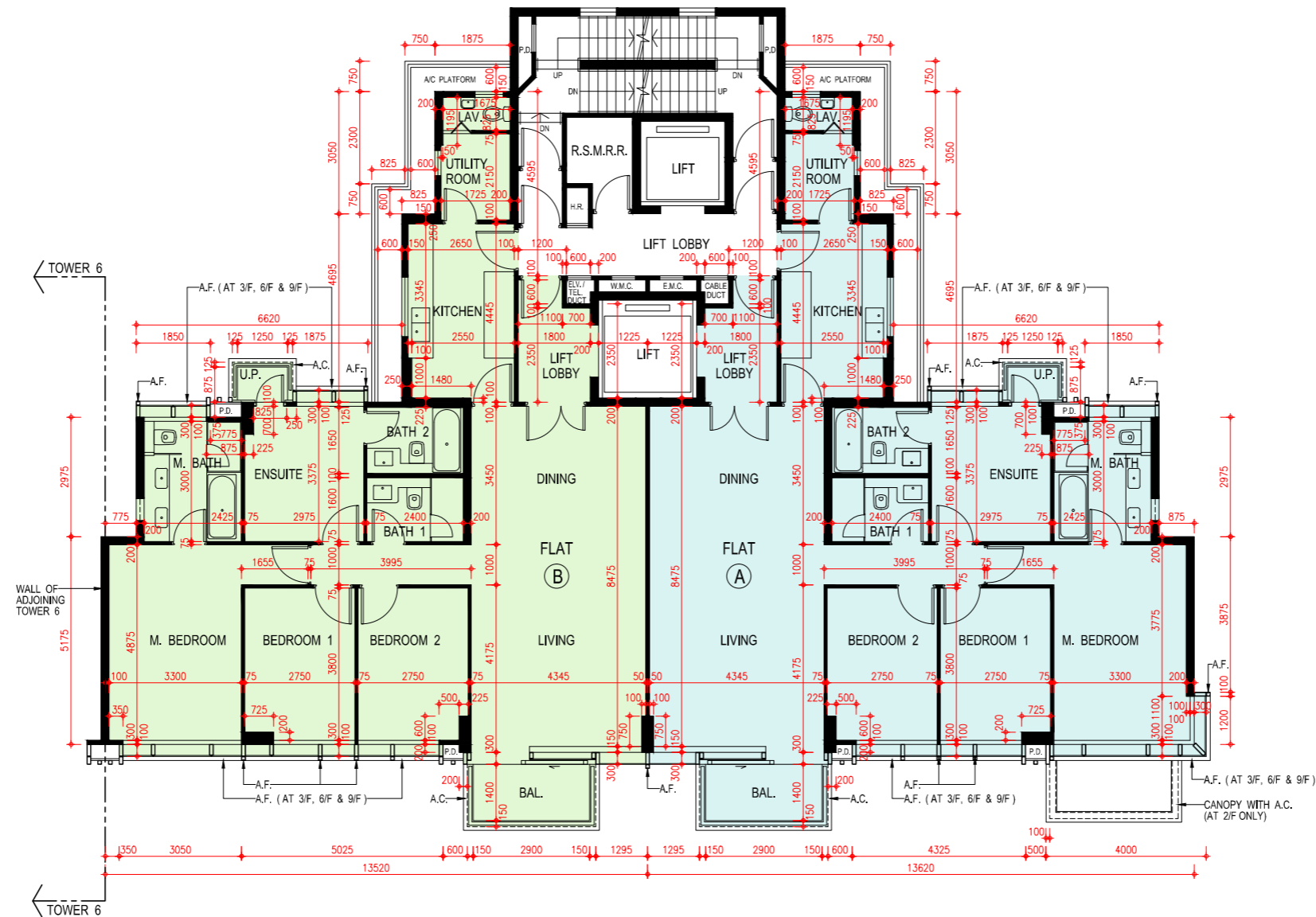
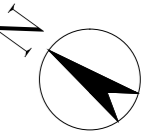

Scale: 0M/米 5M/米  
比例: 5M/米

**Tower 5**

**第5座**

**11/F Plan**

**11樓平面圖**

	Tower 5 第5座
Floor 樓層	11/F 11樓
Flat 單位	Sky Pool Penthouse
The thickness of the floor slabs (excluding plaster) of each residential property (mm) 每個住宅物業的樓板(不包括灰泥)的厚度(毫米)	150, 175
The floor-to-floor heights of each residential property (mm) 每個住宅物業的層與層之間的高度(毫米)	3500, 3550*, 3750*, 3850*, 3950*

The internal areas of the residential properties on the upper floors will generally be slightly larger than those on the lower floors because of the reducing thickness of the structural walls on the upper floors.

因住宅物業的較高樓層的結構牆的厚度遞減，較高樓層的內部面積，一般比較低樓層的內部面積稍大。

Notes:

1. The dimensions of floor plans are all structural dimensions in millimeter.
2. There may be architectural features and/or exposed pipes on external walls of the residential properties. For details, please refer to the latest approved building plans.
3. Common pipes exposed and/or enclosed in cladding are located at/adjacent to flat roof and/or external wall of the residential properties. For details, please refer to the latest approved building plans.
4. There are ceiling bulkheads and/or sunken slab at living/dining room, bedrooms, ensuites, study rooms, utility rooms, store rooms, corridors, bathrooms, powder rooms, lavatories and kitchen of some residential units for the air-conditioning system and/or mechanical and electrical services.
5. Symbols of fittings and fitments shown in the floor plans, such as bathtubs, sink, water closets, shower, sink counter etc are architectural symbols extracted from the latest approved general building plans for general indication only.
6. [\*] Inclusive of the thickness of mass concrete fill on sunken slab.

備註：

1. 平面圖所列之尺寸數字為以毫米標示之建築尺寸。
2. 住宅物業的外牆設有建築裝飾及/或外露喉管。詳細資料請參考最新批准之建築圖則。
3. 住宅物業的平台及/或外牆設有外露及/或外牆裝飾板內藏之公用喉管。詳細資料請參考最新批准的建築圖則。
4. 部份住宅單位的客/飯廳、睡房、套房、書房、工作間、儲物室、走廊、浴室、客廳洗手間、洗手間及廚房有假天花及/或有跌級樓板用以裝置冷氣系統及/或機電設備。
5. 樓面平面圖上所顯示的形象裝置符號，例如浴缸、洗滌盆、坐廁、花灑、洗滌盆櫃乃摘自最新的經批准的建築圖則，並只作一般性標誌。
6. [\*] 包括跌級樓板上之混凝土填充層厚度。



Tower 5  
 第5座

11/F Plan  
 11樓平面圖

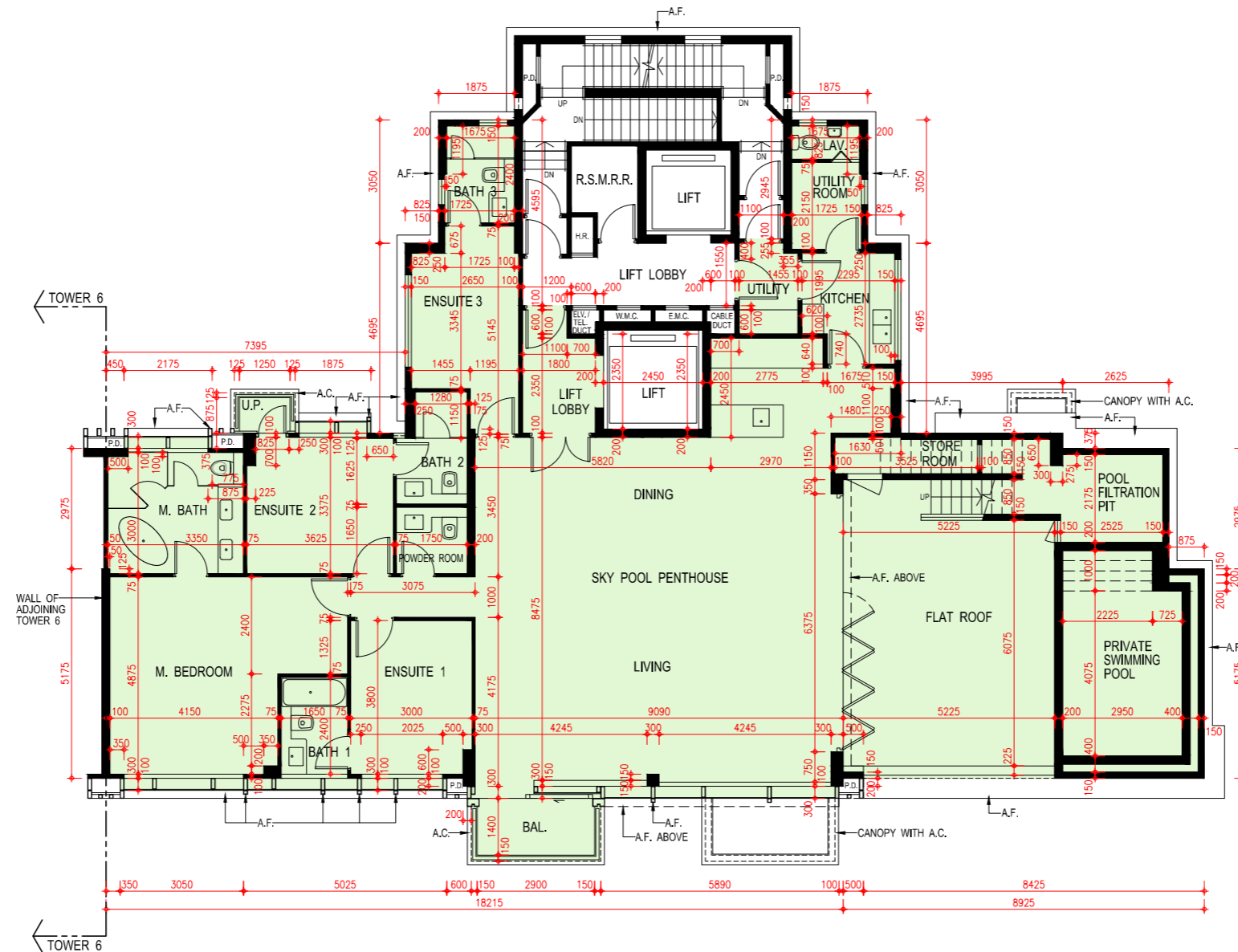
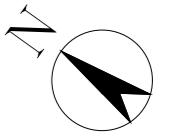

**Tower 5**

**第5座**

**Roof Floor Plan**

**天台平面圖**

	Tower 5 第5座
Floor 樓層	Roof 天台
Flat 單位	Sky Pool Penthouse
The thickness of the floor slabs (excluding plaster) of each residential property (mm) 每個住宅物業的樓板(不包括灰泥)的厚度(毫米)	Not Applicable 不適用
The floor-to-floor heights of each residential property (mm) 每個住宅物業的層與層之間的高度(毫米)	Not Applicable 不適用

The internal areas of the residential properties on the upper floors will generally be slightly larger than those on the lower floors because of the reducing thickness of the structural walls on the upper floors.

因住宅物業的較高樓層的結構牆的厚度遞減，較高樓層的內部面積，一般比較低樓層的內部面積稍大。

Notes:

1. The dimensions of floor plans are all structural dimensions in millimeter.
2. There may be architectural features and/or exposed pipes on external walls of the residential properties. For details, please refer to the latest approved building plans.
3. Common pipes exposed and/or enclosed in cladding are located at/adjacent to flat roof and/or external wall of the residential properties. For details, please refer to the latest approved building plans.
4. There are ceiling bulkheads and/or sunken slab at living/dining room, bedrooms, ensuites, study rooms, utility rooms, store rooms, corridors, bathrooms, powder rooms, lavatories and kitchen of some residential units for the air-conditioning system and/or mechanical and electrical services.
5. Symbols of fittings and fitments shown in the floor plans, such as bathtubs, sink, water closets, shower, sink counter etc are architectural symbols extracted from the latest approved general building plans for general indication only.
6. [\*] Inclusive of the thickness of mass concrete fill on sunken slab.

備註：

1. 平面圖所列之尺寸數字為以毫米標示之建築尺寸。
2. 住宅物業的外牆設有建築裝飾及/或外露喉管。詳細資料請參考最新批准之建築圖則。
3. 住宅物業的平台及/或外牆設有外露及/或外牆裝飾板內藏之公用喉管。詳細資料請參考最新批准的建築圖則。
4. 部份住宅單位的客/飯廳、睡房、套房、書房、工作間、儲物室、走廊、浴室、客廳洗手間、洗手間及廚房有假天花及/或有跌級樓板用以裝置冷氣系統及/或機電設備。
5. 樓面平面圖上所顯示的形象裝置符號，例如浴缸、洗滌盆、坐廁、花灑、洗滌盆櫃乃摘自最新的經批准的建築圖則，並只作一般性標誌。
6. [\*] 包括跌級樓板上之混凝土填充層厚度。

Tower 5  
 第5座

Roof Floor Plan  
 天台平面圖

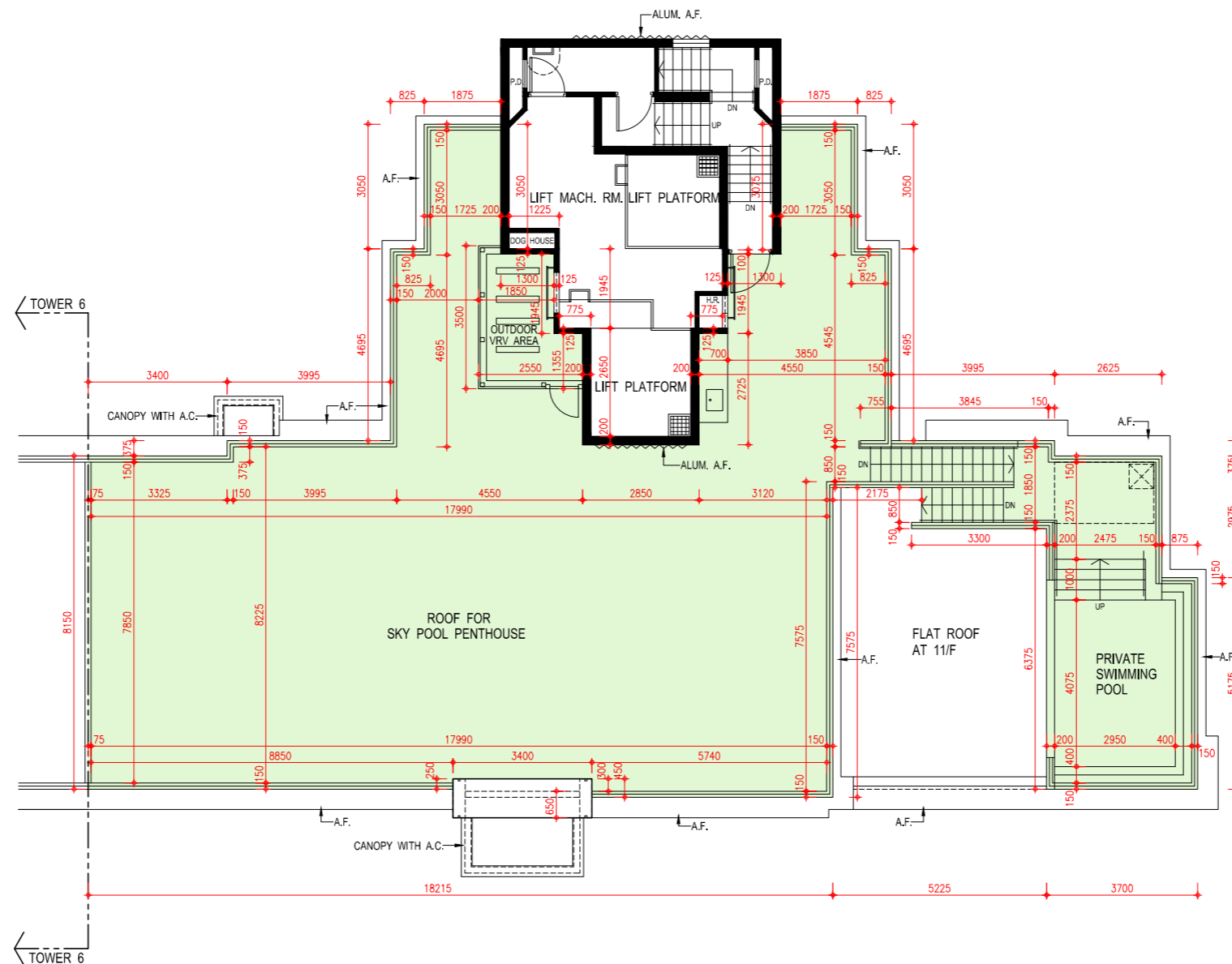
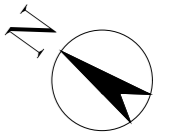

**Tower 6**

**第6座**

**1/F Plan**

**1樓平面圖**

	Tower 6 第6座	
Floor 樓層	1/F 1樓	
Flat 單位	A	B
The thickness of the floor slabs (excluding plaster) of each residential property (mm) 每個住宅物業的樓板(不包括灰泥)的厚度(毫米)	125, 150	125, 150
The floor-to-floor heights of each residential property (mm) 每個住宅物業的層與層之間的高度(毫米)	3150, 3150*	3150, 3150*

The internal areas of the residential properties on the upper floors will generally be slightly larger than those on the lower floors because of the reducing thickness of the structural walls on the upper floors.

因住宅物業的較高樓層的結構牆的厚度遞減，較高樓層的內部面積，一般比較低樓層的內部面積稍大。

Notes:

1. The dimensions of floor plans are all structural dimensions in millimeter.
2. There may be architectural features and/or exposed pipes on external walls of the residential properties. For details, please refer to the latest approved building plans.
3. Common pipes exposed and/or enclosed in cladding are located at/adjacent to flat roof and/or external wall of the residential properties. For details, please refer to the latest approved building plans.
4. There are ceiling bulkheads and/or sunken slab at living/dining room, bedrooms, ensuites, study rooms, utility rooms, store rooms, corridors, bathrooms, powder rooms, lavatories and kitchen of some residential units for the air-conditioning system and/or mechanical and electrical services.
5. Symbols of fittings and fitments shown in the floor plans, such as bathtubs, sink, water closets, shower, sink counter etc are architectural symbols extracted from the latest approved general building plans for general indication only.
6. [\*] Inclusive of the thickness of mass concrete fill on sunken slab.

備註：

1. 平面圖所列之尺寸數字為以毫米標示之建築尺寸。
2. 住宅物業的外牆設有建築裝飾及/或外露喉管。詳細資料請參考最新批准之建築圖則。
3. 住宅物業的平台及/或外牆設有外露及/或外牆裝飾板內藏之公用喉管。詳細資料請參考最新批准的建築圖則。
4. 部份住宅單位的客/飯廳、睡房、套房、書房、工作間、儲物室、走廊、浴室、客廳洗手間、洗手間及廚房有假天花及/或有跌級樓板用以裝置冷氣系統及/或機電設備。
5. 樓面平面圖上所顯示的形象裝置符號，例如浴缸、洗滌盆、坐廁、花灑、洗滌盆櫃乃摘自最新的經批准的建築圖則，並只作一般性標誌。
6. [\*] 包括跌級樓板上之混凝土填充層厚度。

FLOOR PLANS OF RESIDENTIAL PROPERTIES IN THE DEVELOPMENT  
發展項目的住宅物業的樓面平面圖

Tower 6  
第6座

1/F Plan  
1樓平面圖

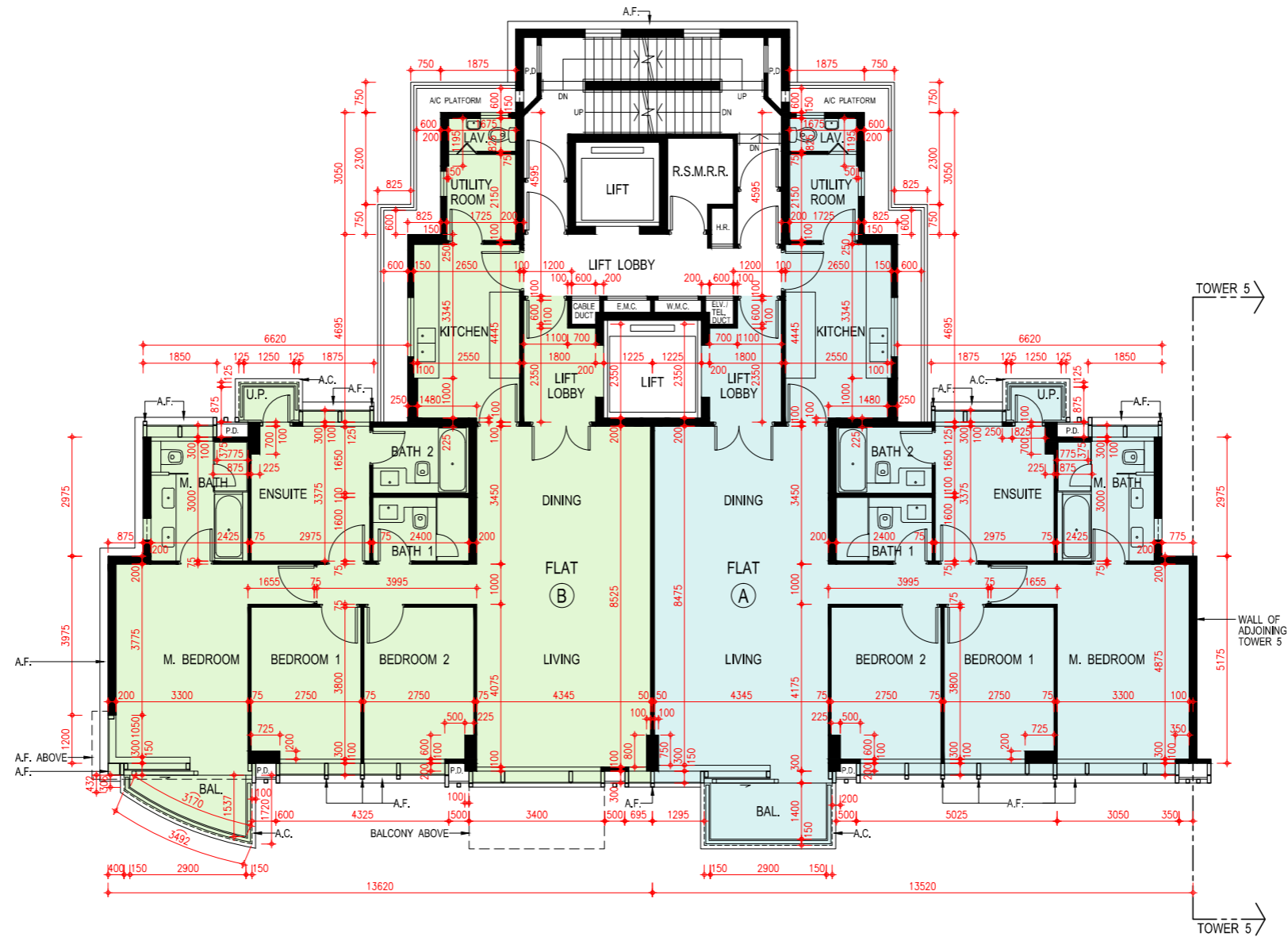
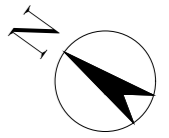

Scale: 0M/米 5M/米  
比例: 5M/米



**Tower 6**

**第6座**

**2/F - 10/F Plan**

**2樓至10樓平面圖**

Floor 樓層	Tower 6 第6座			
	2/F-9/F 2樓至9樓		10/F 10樓	
Flat 單位	A	B	A	B
The thickness of the floor slabs (excluding plaster) of each residential property (mm) 每個住宅物業的樓板(不包括灰泥)的厚度(毫米)	125, 150	125, 150	125, 150, 175	125, 150, 175
The floor-to-floor heights of each residential property (mm) 每個住宅物業的層與層之間的高度(毫米)	3150, 3150*	3150, 3150*	3050, 3150, 3250*, 3300*, 3400*, 3500, 3500*, 3600*, 3700*, 3750*, 3850*	3150, 3200, 3250, 3450*, 3500, 3550*, 3600*, 3700*, 3750*

The internal areas of the residential properties on the upper floors will generally be slightly larger than those on the lower floors because of the reducing thickness of the structural walls on the upper floors.

因住宅物業的較高樓層的結構牆的厚度遞減，較高樓層的內部面積，一般比較低樓層的內部面積稍大。

Notes:

- The dimensions of floor plans are all structural dimensions in millimeter.
- There may be architectural features and/or exposed pipes on external walls of the residential properties. For details, please refer to the latest approved building plans.
- Common pipes exposed and/or enclosed in cladding are located at/adjacent to flat roof and/or external wall of the residential properties. For details, please refer to the latest approved building plans.
- There are ceiling bulkheads and/or sunken slab at living/dining room, bedrooms, ensuites, study rooms, utility rooms, store rooms, corridors, bathrooms, powder rooms, lavatories and kitchen of some residential units for the air-conditioning system and/or mechanical and electrical services.
- Symbols of fittings and fitments shown in the floor plans, such as bathtubs, sink, water closets, shower, sink counter etc are architectural symbols extracted from the latest approved general building plans for general indication only.
- 4/F is omitted.
- [\*] Inclusive of the thickness of mass concrete fill on sunken slab.

備註：

- 平面圖所列之尺寸數字為以毫米標示之建築尺寸。
- 住宅物業的外牆設有建築裝飾及/或外露喉管。詳細資料請參考最新批准之建築圖則。
- 住宅物業的平台及/或外牆設有外露及/或外牆裝飾板內藏之公用喉管。詳細資料請參考最新批准的建築圖則。
- 部份住宅單位的客/飯廳、睡房、套房、書房、工作間、儲物室、走廊、浴室、客廳洗手間、洗手間及廚房有假天花及/或有跌級樓板用以裝置冷氣系統及/或機電設備。
- 樓面平面圖上所顯示的形象裝置符號，例如浴缸、洗滌盆、坐廁、花灑、洗滌盆櫃乃摘自最新的經批准的建築圖則，並只作一般性標誌。
- 不設4樓。
- [\*] 包括跌級樓板上之混凝土填充層厚度。

FLOOR PLANS OF RESIDENTIAL PROPERTIES IN THE DEVELOPMENT  
發展項目的住宅物業的樓面平面圖

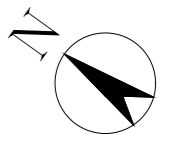

Tower 6  
第6座

2/F - 10/F Plan  
2樓至10樓平面圖

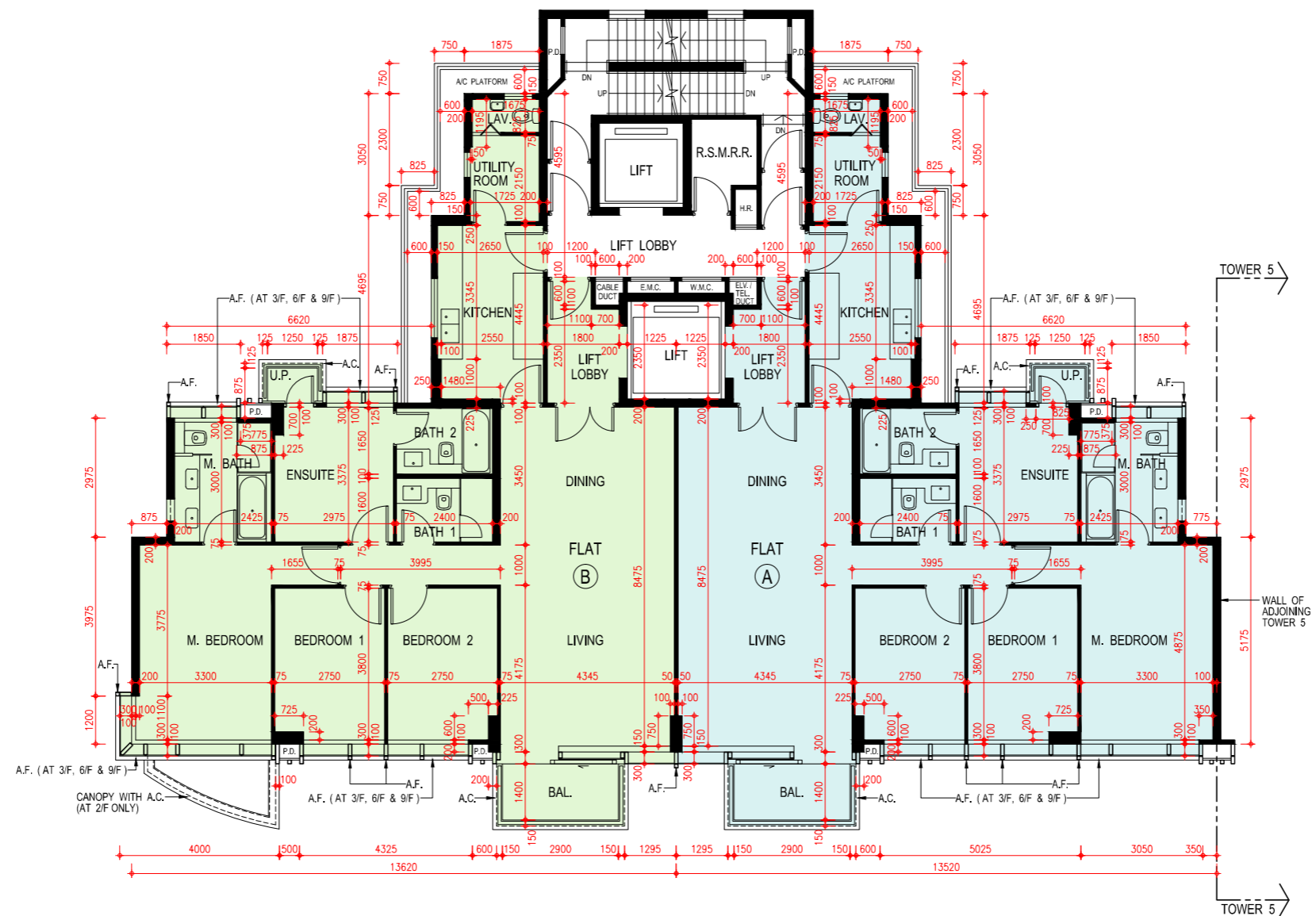

Scale: 0M/米 5M/米  
比例: 5M/米

**Tower 6**

**第 6 座**

**11/F Plan**

**11 樓平面圖**

	Tower 6 第6座
Floor 樓層	11/F 11樓
Flat 單位	Sky Pool Penthouse
The thickness of the floor slabs (excluding plaster) of each residential property (mm) 每個住宅物業的樓板(不包括灰泥)的厚度(毫米)	150, 175
The floor-to-floor heights of each residential property (mm) 每個住宅物業的層與層之間的高度(毫米)	3500, 3550*, 3750*, 3850*, 3950*

The internal areas of the residential properties on the upper floors will generally be slightly larger than those on the lower floors because of the reducing thickness of the structural walls on the upper floors.

因住宅物業的較高樓層的結構牆的厚度遞減，較高樓層的內部面積，一般比較低樓層的內部面積稍大。

Notes:

1. The dimensions of floor plans are all structural dimensions in millimeter.
2. There may be architectural features and/or exposed pipes on external walls of the residential properties. For details, please refer to the latest approved building plans.
3. Common pipes exposed and/or enclosed in cladding are located at/adjacent to flat roof and/or external wall of the residential properties. For details, please refer to the latest approved building plans.
4. There are ceiling bulkheads and/or sunken slab at living/dining room, bedrooms, ensuites, study rooms, utility rooms, store rooms, corridors, bathrooms, powder rooms, lavatories and kitchen of some residential units for the air-conditioning system and/or mechanical and electrical services.
5. Symbols of fittings and fitments shown in the floor plans, such as bathtubs, sink, water closets, shower, sink counter etc are architectural symbols extracted from the latest approved general building plans for general indication only.
6. [\*] Inclusive of the thickness of mass concrete fill on sunken slab.

備註：

1. 平面圖所列之尺寸數字為以毫米標示之建築尺寸。
2. 住宅物業的外牆設有建築裝飾及/或外露喉管。詳細資料請參考最新批准之建築圖則。
3. 住宅物業的平台及/或外牆設有外露及/或外牆裝飾板內藏之公用喉管。詳細資料請參考最新批准的建築圖則。
4. 部份住宅單位的客/飯廳、睡房、套房、書房、工作間、儲物室、走廊、浴室、客廳洗手間、洗手間及廚房有假天花及/或有跌級樓板用以裝置冷氣系統及/或機電設備。
5. 樓面平面圖上所顯示的形象裝置符號，例如浴缸、洗滌盆、坐廁、花灑、洗滌盆櫃乃摘自最新的經批准的建築圖則，並只作一般性標誌。
6. [\*] 包括跌級樓板上之混凝土填充層厚度。



**Tower 6**

**第 6 座**

**Roof Floor Plan**

**天台平面圖**

	Tower 6 第6座
Floor 樓層	Roof 天台
Flat 單位	Sky Pool Penthouse
The thickness of the floor slabs (excluding plaster) of each residential property (mm) 每個住宅物業的樓板(不包括灰泥)的厚度(毫米)	Not Applicable 不適用
The floor-to-floor heights of each residential property (mm) 每個住宅物業的層與層之間的高度(毫米)	Not Applicable 不適用

The internal areas of the residential properties on the upper floors will generally be slightly larger than those on the lower floors because of the reducing thickness of the structural walls on the upper floors.

因住宅物業的較高樓層的結構牆的厚度遞減，較高樓層的內部面積，一般比較低樓層的內部面積稍大。

Notes:

1. The dimensions of floor plans are all structural dimensions in millimeter.
2. There may be architectural features and/or exposed pipes on external walls of the residential properties. For details, please refer to the latest approved building plans.
3. Common pipes exposed and/or enclosed in cladding are located at/adjacent to flat roof and/or external wall of the residential properties. For details, please refer to the latest approved building plans.
4. There are ceiling bulkheads and/or sunken slab at living/dining room, bedrooms, ensuites, study rooms, utility rooms, store rooms, corridors, bathrooms, powder rooms, lavatories and kitchen of some residential units for the air-conditioning system and/or mechanical and electrical services.
5. Symbols of fittings and fitments shown in the floor plans, such as bathtubs, sink, water closets, shower, sink counter etc are architectural symbols extracted from the latest approved general building plans for general indication only.

備註：

1. 平面圖所列之尺寸數字為以毫米標示之建築尺寸。
2. 住宅物業的外牆設有建築裝飾及/或外露喉管。詳細資料請參考最新批准之建築圖則。
3. 住宅物業的平台及/或外牆設有外露及/或外牆裝飾板內藏之公用喉管。詳細資料請參考最新批准的建築圖則。
4. 部份住宅單位的客/飯廳、睡房、套房、書房、工作間、儲物室、走廊、浴室、客廳洗手間、洗手間及廚房有假天花及/或有跌級樓板用以裝置冷氣系統及/或機電設備。
5. 樓面平面圖上所顯示的形象裝置符號，例如浴缸、洗滌盆、坐廁、花灑、洗滌盆櫃乃摘自最新的經批准的建築圖則，並只作一般性標誌。



Tower 6  
 第6座

Roof Floor Plan  
 天台平面圖

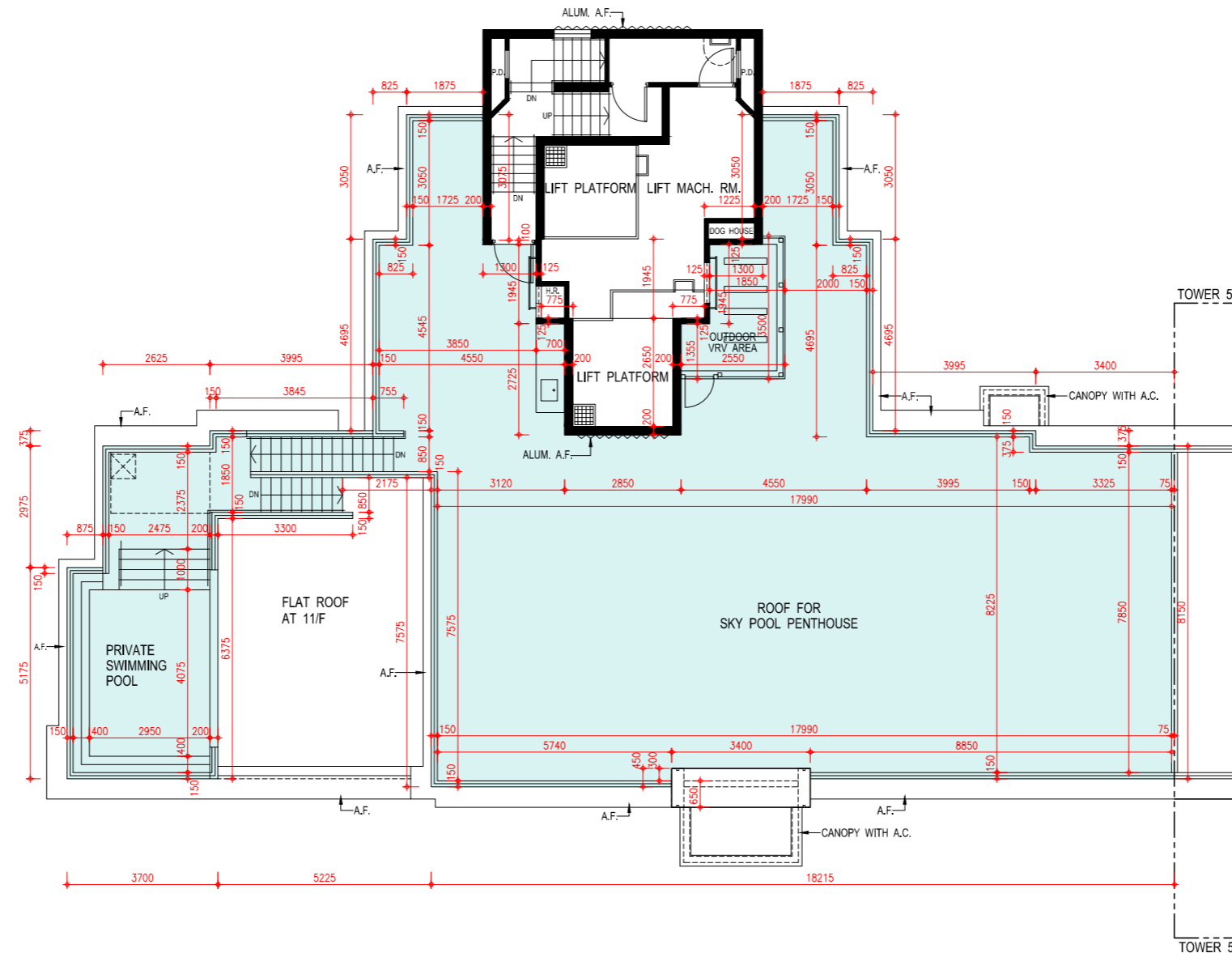
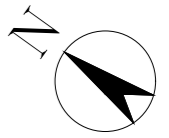

**Tower 7**

**第7座**

**G/F Plan**

**地下平面圖**

	Tower 7 第7座
Floor 樓層	G/F 地下
Flat 單位	• Garden Apartment
The thickness of the floor slabs (excluding plaster) of each residential property (mm) 每個住宅物業的樓板(不包括灰泥)的厚度(毫米)	125, 150
The floor-to-floor heights of each residential property (mm) 每個住宅物業的層與層之間的高度(毫米)	3100, 3200, 3250, 3300*, 3450, 3450*, 3550*, 3600*, 3800*

The internal areas of the residential properties on the upper floors will generally be slightly larger than those on the lower floors because of the reducing thickness of the structural walls on the upper floors.

因住宅物業的較高樓層的結構牆的厚度遞減，較高樓層的內部面積，一般比較低樓層的內部面積稍大。

Notes:

- The dimensions of floor plans are all structural dimensions in millimeter.
- There may be architectural features and/or exposed pipes on external walls of the residential properties. For details, please refer to the latest approved building plans.
- Common pipes exposed and/or enclosed in cladding are located at/adjacent to flat roof and/or external wall of the residential properties. For details, please refer to the latest approved building plans.
- There are ceiling bulkheads and/or sunken slab at living/dining room, bedrooms, ensuites, study rooms, utility rooms, store rooms, corridors, bathrooms, powder rooms, lavatories and kitchen of some residential units for the air-conditioning system and/or mechanical and electrical services.
- Symbols of fittings and fitments shown in the floor plans, such as bathtubs, sink, water closets, shower, sink counter etc are architectural symbols extracted from the latest approved general building plans for general indication only.
- “Terrace Apartment”, “Garden Apartment” and “Courtyard Penthouse” are names for marketing purposes only and will not appear in any Deed of Mutual Covenant, the Preliminary Agreement for Sale and Purchase, Agreement for Sale and Purchase, Assignment, or any other title deeds and documents relating to the Development. The names as appearing on the approved building plans are: Flat A on 1/F of Tower 1 for Terrace Apartment on 1/F of Tower 1; Flat B on G/F of Tower 2 for Garden Apartment on G/F of Tower 2; Flat B on G/F of Tower 3 for Garden Apartment on G/F of Tower 3; Flat A on G/F of Tower 7 for Garden Apartment on G/F of Tower 7; Penthouse on 11/F of Tower 7 for Courtyard Penthouse on 11/F of Tower 7; Flat B on G/F of Tower 8 for Garden Apartment on G/F of Tower 8; Penthouse on 11/F of Tower 8 for Courtyard Penthouse on 11/F of Tower 8.
- [\*] Inclusive of the thickness of mass concrete fill on sunken slab.

備註：

- 平面圖所列之尺寸數字為以毫米標示之建築尺寸。
- 住宅物業的外牆設有建築裝飾及/或外露喉管。詳細資料請參考最新批准之建築圖則。
- 住宅物業的平台及/或外牆設有外露及/或外牆裝飾板內藏之公用喉管。詳細資料請參考最新批准的建築圖則。
- 部份住宅單位的客/飯廳、睡房、套房、書房、工作間、儲物室、走廊、浴室、客廳洗手間、洗手間及廚房有假天花及/或有跌級樓板用以裝置冷氣系統及/或機電設備。
- 樓面平面圖上所顯示的形象裝置符號，例如浴缸、洗滌盆、坐廁、花灑、洗滌盆櫃乃摘自最新的經批准的建築圖則，並只作一般性標誌。
- 「Terrace Apartment」、「Garden Apartment」及「Courtyard Penthouse」僅為市場推廣之用的名稱，並不會於關於發展項目的任何公契、臨時買賣合約、買賣合約、轉讓契及契據出現。經批准的建築圖則上顯示的名稱為：第1座1樓A單位（即第1座1樓Terrace Apartment）；第2座地下B單位（即第2座地下Garden Apartment）；第3座地下B單位（即第3座地下Garden Apartment）；第7座地下A單位（即第7座地下Garden Apartment）；第7座11樓Penthouse（即第7座11樓Courtyard Penthouse）；第8座地下B單位（即第8座地下Garden Apartment）；第8座11樓Penthouse（即第8座11樓Courtyard Penthouse）。
- [\*] 包括跌級樓板上之混凝土填充層厚度。

FLOOR PLANS OF RESIDENTIAL PROPERTIES IN THE DEVELOPMENT  
發展項目的住宅物業的樓面平面圖

Tower 7  
第7座

G/F Plan  
地下平面圖

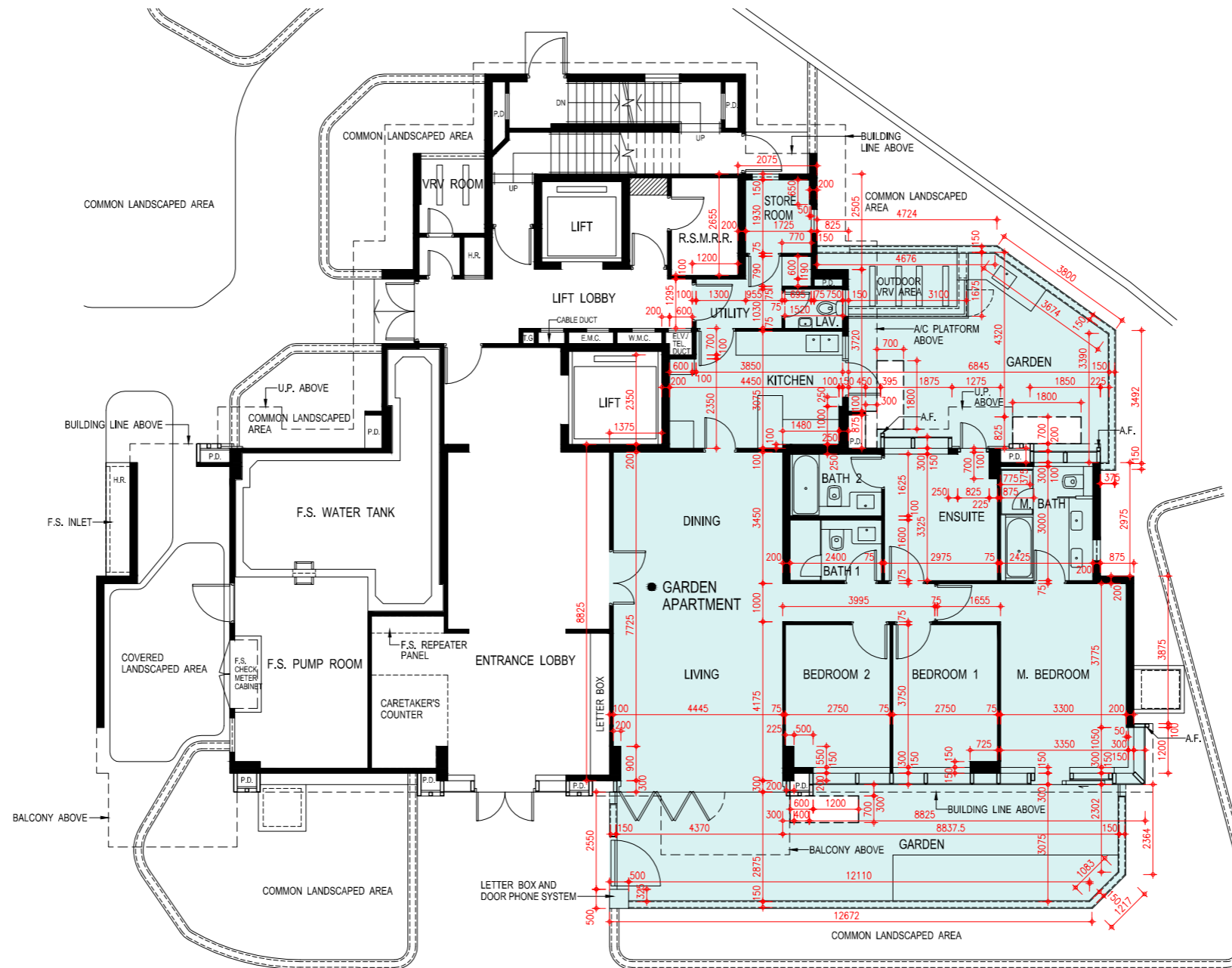
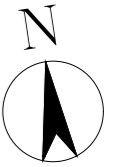

Scale: 0M/米 5M/米  
比例: 126

**Tower 7**

**第7座**

**1/F Plan**

**1樓平面圖**

	Tower 7 第7座	
Floor 樓層	1/F 1樓	
Flat 單位	A	B
The thickness of the floor slabs (excluding plaster) of each residential property (mm) 每個住宅物業的樓板(不包括灰泥)的厚度(毫米)	125, 150	125, 150
The floor-to-floor heights of each residential property (mm) 每個住宅物業的層與層之間的高度(毫米)	3150, 3150*	3150, 3150*

The internal areas of the residential properties on the upper floors will generally be slightly larger than those on the lower floors because of the reducing thickness of the structural walls on the upper floors.

因住宅物業的較高樓層的結構牆的厚度遞減，較高樓層的內部面積，一般比較低樓層的內部面積稍大。

Notes:

1. The dimensions of floor plans are all structural dimensions in millimeter.
2. There may be architectural features and/or exposed pipes on external walls of the residential properties. For details, please refer to the latest approved building plans.
3. Common pipes exposed and/or enclosed in cladding are located at/adjacent to flat roof and/or external wall of the residential properties. For details, please refer to the latest approved building plans.
4. There are ceiling bulkheads and/or sunken slab at living/dining room, bedrooms, ensuites, study rooms, utility rooms, store rooms, corridors, bathrooms, powder rooms, lavatories and kitchen of some residential units for the air-conditioning system and/or mechanical and electrical services.
5. Symbols of fittings and fitments shown in the floor plans, such as bathtubs, sink, water closets, shower, sink counter etc are architectural symbols extracted from the latest approved general building plans for general indication only.
6. [\*] Inclusive of the thickness of mass concrete fill on sunken slab.

備註：

1. 平面圖所列之尺寸數字為以毫米標示之建築尺寸。
2. 住宅物業的外牆設有建築裝飾及/或外露喉管。詳細資料請參考最新批准之建築圖則。
3. 住宅物業的平台及/或外牆設有外露及/或外牆裝飾板內藏之公用喉管。詳細資料請參考最新批准的建築圖則。
4. 部份住宅單位的客/飯廳、睡房、套房、書房、工作間、儲物室、走廊、浴室、客廳洗手間、洗手間及廚房有假天花及/或有跌級樓板用以裝置冷氣系統及/或機電設備。
5. 樓面平面圖上所顯示的形象裝置符號，例如浴缸、洗滌盆、坐廁、花灑、洗滌盆櫃乃摘自最新的經批准的建築圖則，並只作一般性標誌。
6. [\*] 包括跌級樓板上之混凝土填充層厚度。

FLOOR PLANS OF RESIDENTIAL PROPERTIES IN THE DEVELOPMENT  
發展項目的住宅物業的樓面平面圖

Tower 7  
第7座

1/F Plan  
1樓平面圖

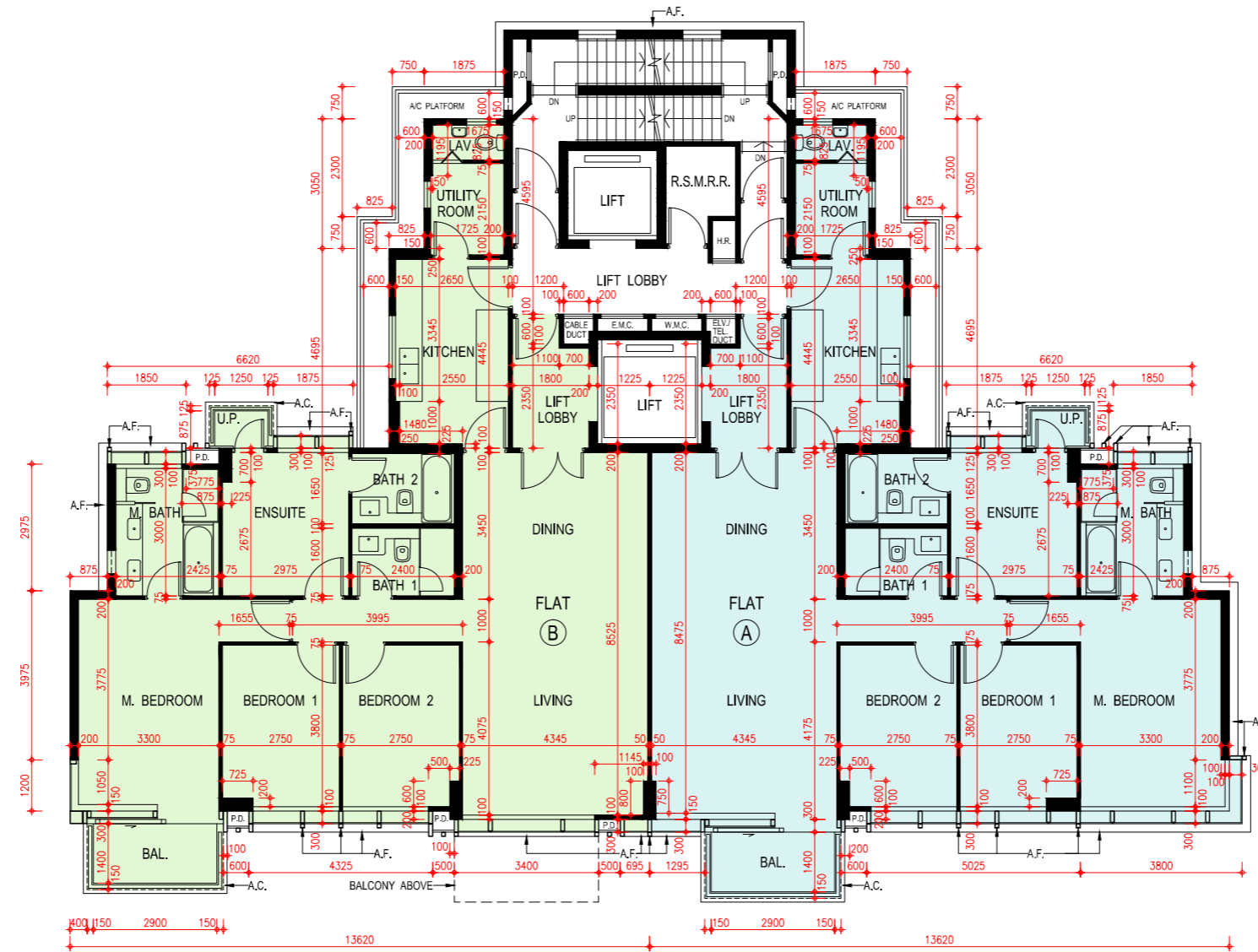
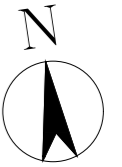

Scale: 0M/米 5M/米  
比例: 10M



**Tower 7**

**第7座**

**2/F - 10/F Plan**

**2樓至10樓平面圖**

Floor 樓層	Tower 7 第7座			
	2/F-9/F 2樓至9樓		10/F 10樓	
	A	B	A	B
Flat 單位				
The thickness of the floor slabs (excluding plaster) of each residential property (mm) 每個住宅物業的樓板(不包括灰泥)的厚度(毫米)	125, 150	125, 150	125, 150, 175	125, 150, 175
The floor-to-floor heights of each residential property (mm) 每個住宅物業的層與層之間的高度(毫米)	3150, 3150*	3150, 3150*	3075, 3200, 3250*, 3425*, 3450*, 3500, 3500*, 3600*, 3725*, 3750*, 3850*	2750, 2950, 3050, 3150, 3200, 3250, 3300*, 3400*, 3500, 3500*, 3600*, 3700*, 3750*, 3850*

The internal areas of the residential properties on the upper floors will generally be slightly larger than those on the lower floors because of the reducing thickness of the structural walls on the upper floors.

因住宅物業的較高樓層的結構牆的厚度遞減，較高樓層的內部面積，一般比較低樓層的內部面積稍大。

Notes:

- The dimensions of floor plans are all structural dimensions in millimeter.
- There may be architectural features and/or exposed pipes on external walls of the residential properties. For details, please refer to the latest approved building plans.
- Common pipes exposed and/or enclosed in cladding are located at/adjacent to flat roof and/or external wall of the residential properties. For details, please refer to the latest approved building plans.
- There are ceiling bulkheads and/or sunken slab at living/dining room, bedrooms, ensuites, study rooms, utility rooms, store rooms, corridors, bathrooms, powder rooms, lavatories and kitchen of some residential units for the air-conditioning system and/or mechanical and electrical services.
- Symbols of fittings and fitments shown in the floor plans, such as bathtubs, sink, water closets, shower, sink counter etc are architectural symbols extracted from the latest approved general building plans for general indication only.
- 4/F is omitted.
- [\*] Inclusive of the thickness of mass concrete fill on sunken slab.

備註：

- 平面圖所列之尺寸數字為以毫米標示之建築尺寸。
- 住宅物業的外牆設有建築裝飾及/或外露喉管。詳細資料請參考最新批准之建築圖則。
- 住宅物業的平台及/或外牆設有外露及/或外牆裝飾板內藏之公用喉管。詳細資料請參考最新批准的建築圖則。
- 部份住宅單位的客/飯廳、睡房、套房、書房、工作間、儲物室、走廊、浴室、客廳洗手間、洗手間及廚房有假天花及/或有跌級樓板用以裝置冷氣系統及/或機電設備。
- 樓面平面圖上所顯示的形象裝置符號，例如浴缸、洗滌盆、坐廁、花灑、洗滌盆櫃乃摘自最新的經批准的建築圖則，並只作一般性標誌。
- 不設4樓。
- [\*] 包括跌級樓板上之混凝土填充層厚度。

FLOOR PLANS OF RESIDENTIAL PROPERTIES IN THE DEVELOPMENT  
 發展項目的住宅物業的樓面平面圖

Tower 7  
 第7座

2/F - 10/F Plan  
 2樓至10樓平面圖

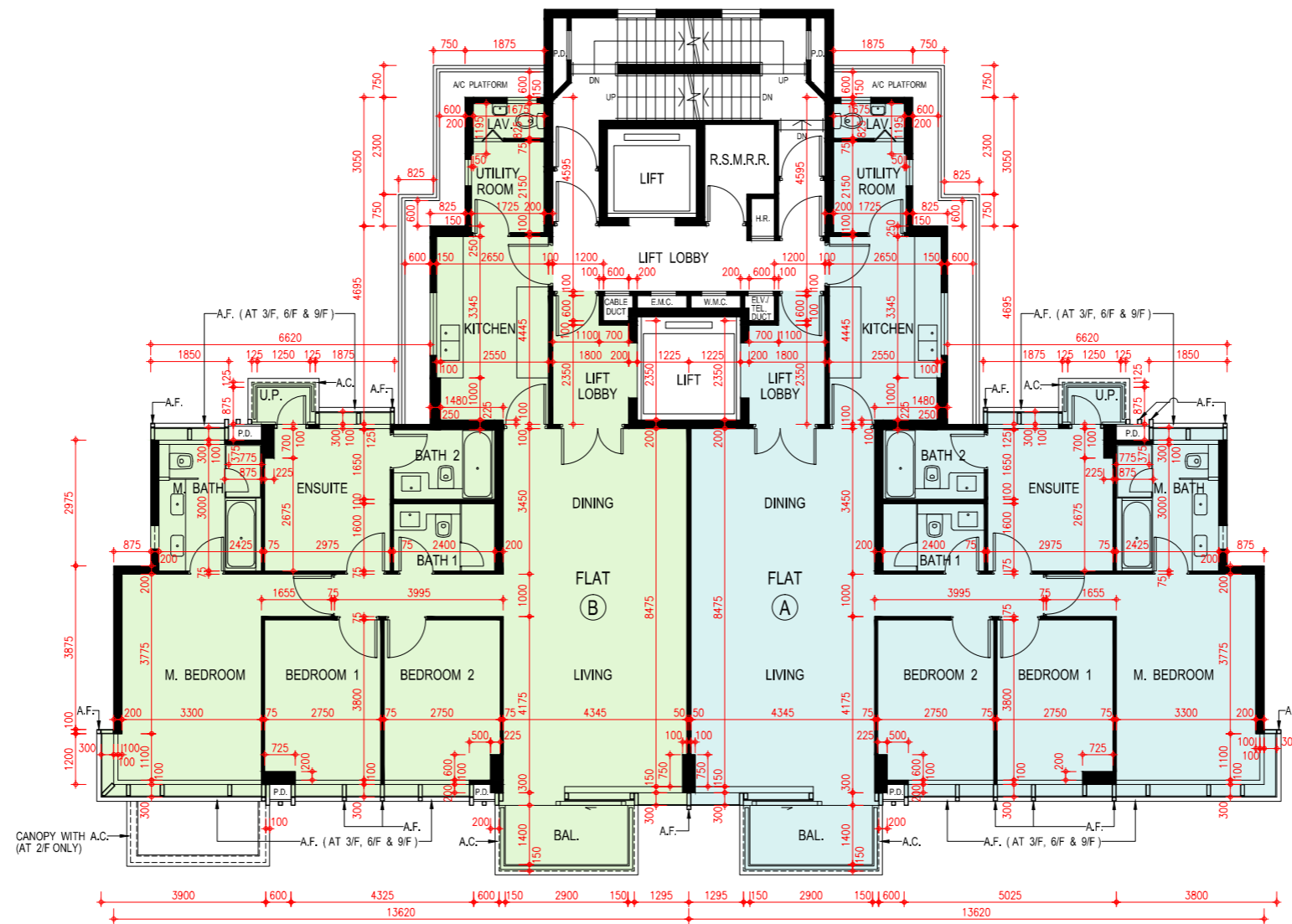
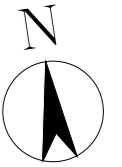

Scale: 0M/米 5M/米  
 比例: 5M/米

## FLOOR PLANS OF RESIDENTIAL PROPERTIES IN THE DEVELOPMENT

### 發展項目的住宅物業的樓面平面圖

#### Tower 7

#### 第7座

#### 11/F Plan

#### 11樓平面圖

	Tower 7 第7座
Floor 樓層	11/F 11樓
Flat 單位	• Courtyard Penthouse
The thickness of the floor slabs (excluding plaster) of each residential property (mm) 每個住宅物業的樓板(不包括灰泥)的厚度(毫米)	150, 175
The floor-to-floor heights of each residential property (mm) 每個住宅物業的層與層之間的高度(毫米)	3500, 3550*, 3750*, 3850*, 3925*, 3950*, 4050*

The internal areas of the residential properties on the upper floors will generally be slightly larger than those on the lower floors because of the reducing thickness of the structural walls on the upper floors.

因住宅物業的較高樓層的結構牆的厚度遞減，較高樓層的內部面積，一般比較低樓層的內部面積稍大。

#### Notes:

- The dimensions of floor plans are all structural dimensions in millimeter.
- There may be architectural features and/or exposed pipes on external walls of the residential properties. For details, please refer to the latest approved building plans.
- Common pipes exposed and/or enclosed in cladding are located at/adjacent to flat roof and/or external wall of the residential properties. For details, please refer to the latest approved building plans.
- There are ceiling bulkheads and/or sunken slab at living/dining room, bedrooms, ensuites, study rooms, utility rooms, store rooms, corridors, bathrooms, powder rooms, lavatories and kitchen of some residential units for the air-conditioning system and/or mechanical and electrical services.
- Symbols of fittings and fitments shown in the floor plans, such as bathtubs, sink, water closets, shower, sink counter etc are architectural symbols extracted from the latest approved general building plans for general indication only.
- "Terrace Apartment", "Garden Apartment" and "Courtyard Penthouse" are names for marketing purposes only and will not appear in any Deed of Mutual Covenant, the Preliminary Agreement for Sale and Purchase, Agreement for Sale and Purchase, Assignment, or any other title deeds and documents relating to the Development. The names as appearing on the approved building plans are: Flat A on 1/F of Tower 1 for Terrace Apartment on 1/F of Tower 1; Flat B on G/F of Tower 2 for Garden Apartment on G/F of Tower 2; Flat B on G/F of Tower 3 for Garden Apartment on G/F of Tower 3; Flat A on G/F of Tower 7 for Garden Apartment on G/F of Tower 7; Penthouse on 11/F of Tower 7 for Courtyard Penthouse on 11/F of Tower 7; Flat B on G/F of Tower 8 for Garden Apartment on G/F of Tower 8; Penthouse on 11/F of Tower 8 for Courtyard Penthouse on 11/F of Tower 8.
- [\*] Inclusive of the thickness of mass concrete fill on sunken slab.

#### 備註：

- 平面圖所列之尺寸數字為以毫米標示之建築尺寸。
- 住宅物業的外牆設有建築裝飾及/或外露喉管。詳細資料請參考最新批准之建築圖則。
- 住宅物業的平台及/或外牆設有外露及/或外牆裝飾板內藏之公用喉管。詳細資料請參考最新批准的建築圖則。
- 部份住宅單位的客/飯廳、睡房、套房、書房、工作間、儲物室、走廊、浴室、客廳洗手間、洗手間及廚房有假天花及/或有跌級樓板用以裝置冷氣系統及/或機電設備。
- 樓面平面圖上所顯示的形象裝置符號，例如浴缸、洗滌盆、坐廁、花灑、洗滌盆櫃乃摘自最新的經批准的建築圖則，並只作一般性標誌。
- 「Terrace Apartment」、「Garden Apartment」及「Courtyard Penthouse」僅為市場推廣之用的名稱，並不會於關於發展項目的任何公契、臨時買賣合約、買賣合約、轉讓契及契據出現。經批准的建築圖則上顯示的名稱為：第1座1樓A單位（即第1座1樓Terrace Apartment）；第2座地下B單位（即第2座地下Garden Apartment）；第3座地下B單位（即第3座地下Garden Apartment）；第7座地下A單位（即第7座地下Garden Apartment）；第7座11樓Penthouse（即第7座11樓Courtyard Penthouse）；第8座地下B單位（即第8座地下Garden Apartment）；第8座11樓Penthouse（即第8座11樓Courtyard Penthouse）。
- [\*] 包括跌級樓板上之混凝土填充層厚度。

FLOOR PLANS OF RESIDENTIAL PROPERTIES IN THE DEVELOPMENT  
 發展項目的住宅物業的樓面平面圖

Tower 7  
 第7座

11/F Plan  
 11樓平面圖

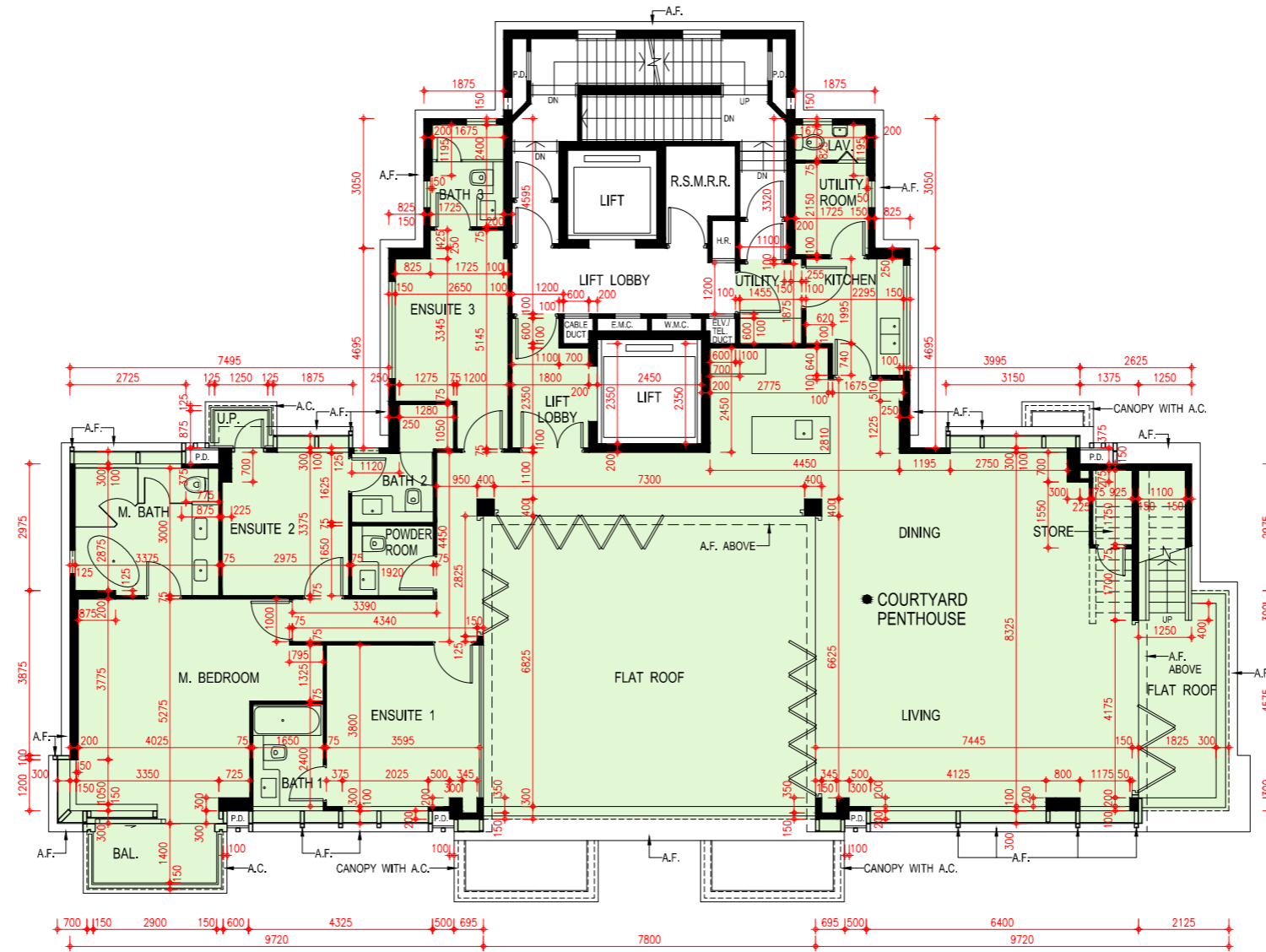
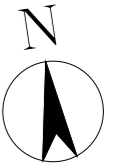

Scale: 0M/米 5M/米  
 比例: 5M/米

Tower 7

第7座

Roof Floor Plan

天台平面圖

	Tower 7 第7座
Floor 樓層	Roof 天台
Flat 單位	• Courtyard Penthouse
The thickness of the floor slabs (excluding plaster) of each residential property (mm) 每個住宅物業的樓板(不包括灰泥)的厚度(毫米)	Not Applicable 不適用
The floor-to-floor heights of each residential property (mm) 每個住宅物業的層與層之間的高度(毫米)	Not Applicable 不適用

The internal areas of the residential properties on the upper floors will generally be slightly larger than those on the lower floors because of the reducing thickness of the structural walls on the upper floors.

因住宅物業的較高樓層的結構牆的厚度遞減，較高樓層的內部面積，一般比較低樓層的內部面積稍大。

Notes:

- The dimensions of floor plans are all structural dimensions in millimeter.
- There may be architectural features and/or exposed pipes on external walls of the residential properties. For details, please refer to the latest approved building plans.
- Common pipes exposed and/or enclosed in cladding are located at/adjacent to flat roof and/or external wall of the residential properties. For details, please refer to the latest approved building plans.
- There are ceiling bulkheads and/or sunken slab at living/dining room, bedrooms, ensuites, study rooms, utility rooms, store rooms, corridors, bathrooms, powder rooms, lavatories and kitchen of some residential units for the air-conditioning system and/or mechanical and electrical services.
- Symbols of fittings and fitments shown in the floor plans, such as bathtubs, sink, water closets, shower, sink counter etc are architectural symbols extracted from the latest approved general building plans for general indication only.
- "Terrace Apartment", "Garden Apartment" and "Courtyard Penthouse" are names for marketing purposes only and will not appear in any Deed of Mutual Covenant, the Preliminary Agreement for Sale and Purchase, Agreement for Sale and Purchase, Assignment, or any other title deeds and documents relating to the Development. The names as appearing on the approved building plans are: Flat A on 1/F of Tower 1 for Terrace Apartment on 1/F of Tower 1; Flat B on G/F of Tower 2 for Garden Apartment on G/F of Tower 2; Flat B on G/F of Tower 3 for Garden Apartment on G/F of Tower 3; Flat A on G/F of Tower 7 for Garden Apartment on G/F of Tower 7; Penthouse on 11/F of Tower 7 for Courtyard Penthouse on 11/F of Tower 7; Flat B on G/F of Tower 8 for Garden Apartment on G/F of Tower 8; Penthouse on 11/F of Tower 8 for Courtyard Penthouse on 11/F of Tower 8.

備註：

- 平面圖所列之尺寸數字為以毫米標示之建築尺寸。
- 住宅物業的外牆設有建築裝飾及/或外露喉管。詳細資料請參考最新批准之建築圖則。
- 住宅物業的平台及/或外牆設有外露及/或外牆裝飾板內藏之公用喉管。詳細資料請參考最新批准的建築圖則。
- 部份住宅單位的客/飯廳、睡房、套房、書房、工作間、儲物室、走廊、浴室、客廳洗手間、洗手間及廚房有假天花及/或有跌級樓板用以裝置冷氣系統及/或機電設備。
- 樓面平面圖上所顯示的形象裝置符號，例如浴缸、洗滌盆、坐廁、花灑、洗滌盆櫃乃摘自最新的經批准的建築圖則，並只作一般性標誌。
- 「Terrace Apartment」、「Garden Apartment」及「Courtyard Penthouse」僅為市場推廣之用的名稱，並不會於關於發展項目的任何公契、臨時買賣合約、買賣合約、轉讓契及契據出現。經批准的建築圖則上顯示的名稱為：第1座1樓A單位（即第1座1樓Terrace Apartment）；第2座地下B單位（即第2座地下Garden Apartment）；第3座地下B單位（即第3座地下Garden Apartment）；第7座地下A單位（即第7座地下Garden Apartment）；第7座11樓Penthouse（即第7座11樓Courtyard Penthouse）；第8座地下B單位（即第8座地下Garden Apartment）；第8座11樓Penthouse（即第8座11樓Courtyard Penthouse）。



Tower 7  
第7座

Roof Floor Plan  
天台平面圖

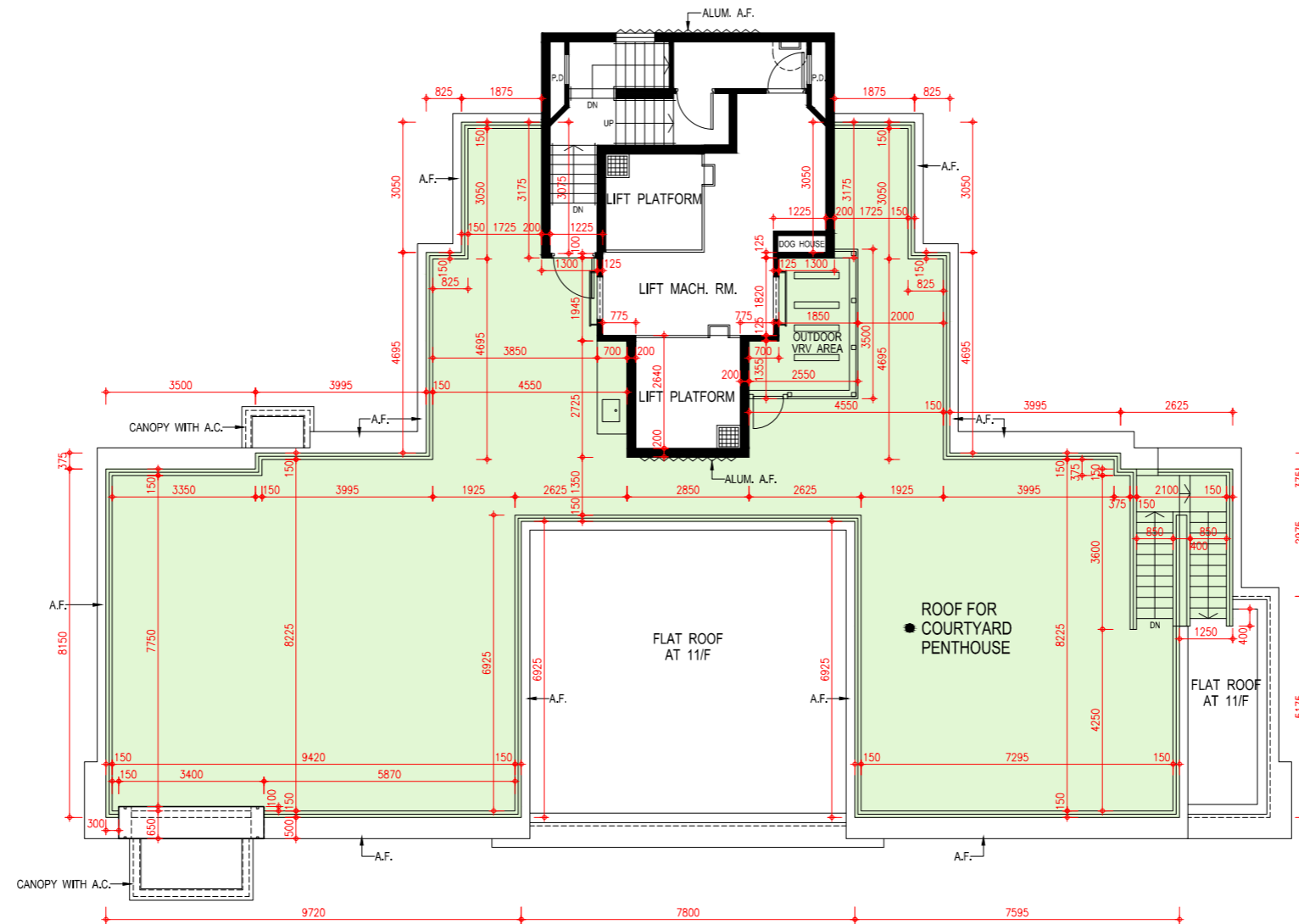
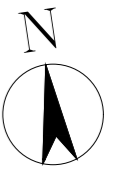

## FLOOR PLANS OF RESIDENTIAL PROPERTIES IN THE DEVELOPMENT

### 發展項目的住宅物業的樓面平面圖

#### Tower 8

#### 第8座

#### G/F Plan

#### 地下平面圖

	Tower 8 第8座
Floor 樓層	G/F 地下
Flat 單位	• Garden Apartment
The thickness of the floor slabs (excluding plaster) of each residential property (mm) 每個住宅物業的樓板(不包括灰泥)的厚度(毫米)	125, 150
The floor-to-floor heights of each residential property (mm) 每個住宅物業的層與層之間的高度(毫米)	3100, 3200, 3250, 3300*, 3450, 3450*, 3550*, 3600*, 3800*

The internal areas of the residential properties on the upper floors will generally be slightly larger than those on the lower floors because of the reducing thickness of the structural walls on the upper floors.

因住宅物業的較高樓層的結構牆的厚度遞減，較高樓層的內部面積，一般比較低樓層的內部面積稍大。

#### Notes:

- The dimensions of floor plans are all structural dimensions in millimeter.
- There may be architectural features and/or exposed pipes on external walls of the residential properties. For details, please refer to the latest approved building plans.
- Common pipes exposed and/or enclosed in cladding are located at/adjacent to flat roof and/or external wall of the residential properties. For details, please refer to the latest approved building plans.
- There are ceiling bulkheads and/or sunken slab at living/dining room, bedrooms, ensuites, study rooms, utility rooms, store rooms, corridors, bathrooms, powder rooms, lavatories and kitchen of some residential units for the air-conditioning system and/or mechanical and electrical services.
- Symbols of fittings and fitments shown in the floor plans, such as bathtubs, sink, water closets, shower, sink counter etc are architectural symbols extracted from the latest approved general building plans for general indication only.
- "Terrace Apartment", "Garden Apartment" and "Courtyard Penthouse" are names for marketing purposes only and will not appear in any Deed of Mutual Covenant, the Preliminary Agreement for Sale and Purchase, Agreement for Sale and Purchase, Assignment, or any other title deeds and documents relating to the Development. The names as appearing on the approved building plans are: Flat A on 1/F of Tower 1 for Terrace Apartment on 1/F of Tower 1; Flat B on G/F of Tower 2 for Garden Apartment on G/F of Tower 2; Flat B on G/F of Tower 3 for Garden Apartment on G/F of Tower 3; Flat A on G/F of Tower 7 for Garden Apartment on G/F of Tower 7; Penthouse on 11/F of Tower 7 for Courtyard Penthouse on 11/F of Tower 7; Flat B on G/F of Tower 8 for Garden Apartment on G/F of Tower 8; Penthouse on 11/F of Tower 8 for Courtyard Penthouse on 11/F of Tower 8.
- [\*] Inclusive of the thickness of mass concrete fill on sunken slab.

#### 備註：

- 平面圖所列之尺寸數字為以毫米標示之建築尺寸。
- 住宅物業的外牆設有建築裝飾及/或外露喉管。詳細資料請參考最新批准之建築圖則。
- 住宅物業的平台及/或外牆設有外露及/或外牆裝飾板內藏之公用喉管。詳細資料請參考最新批准的建築圖則。
- 部份住宅單位的客/飯廳、睡房、套房、書房、工作間、儲物室、走廊、浴室、客廳洗手間、洗手間及廚房有假天花及/或有跌級樓板用以裝置冷氣系統及/或機電設備。
- 樓面平面圖上所顯示的形象裝置符號，例如浴缸、洗滌盆、坐廁、花灑、洗滌盆櫃乃摘自最新的經批准的建築圖則，並只作一般性標誌。
- 「Terrace Apartment」、「Garden Apartment」及「Courtyard Penthouse」僅為市場推廣之用的名稱，並不會於關於發展項目的任何公契、臨時買賣合約、買賣合約、轉讓契及契據出現。經批准的建築圖則上顯示的名稱為：第1座1樓A單位（即第1座1樓Terrace Apartment）；第2座地下B單位（即第2座地下Garden Apartment）；第3座地下B單位（即第3座地下Garden Apartment）；第7座地下A單位（即第7座地下Garden Apartment）；第7座11樓Penthouse（即第7座11樓Courtyard Penthouse）；第8座地下B單位（即第8座地下Garden Apartment）；第8座11樓Penthouse（即第8座11樓Courtyard Penthouse）。
- [\*] 包括跌級樓板上之混凝土填充層厚度。

FLOOR PLANS OF RESIDENTIAL PROPERTIES IN THE DEVELOPMENT

發展項目的住宅物業的樓面平面圖

Tower 8

第 8 座

G/F Plan

地下平面圖

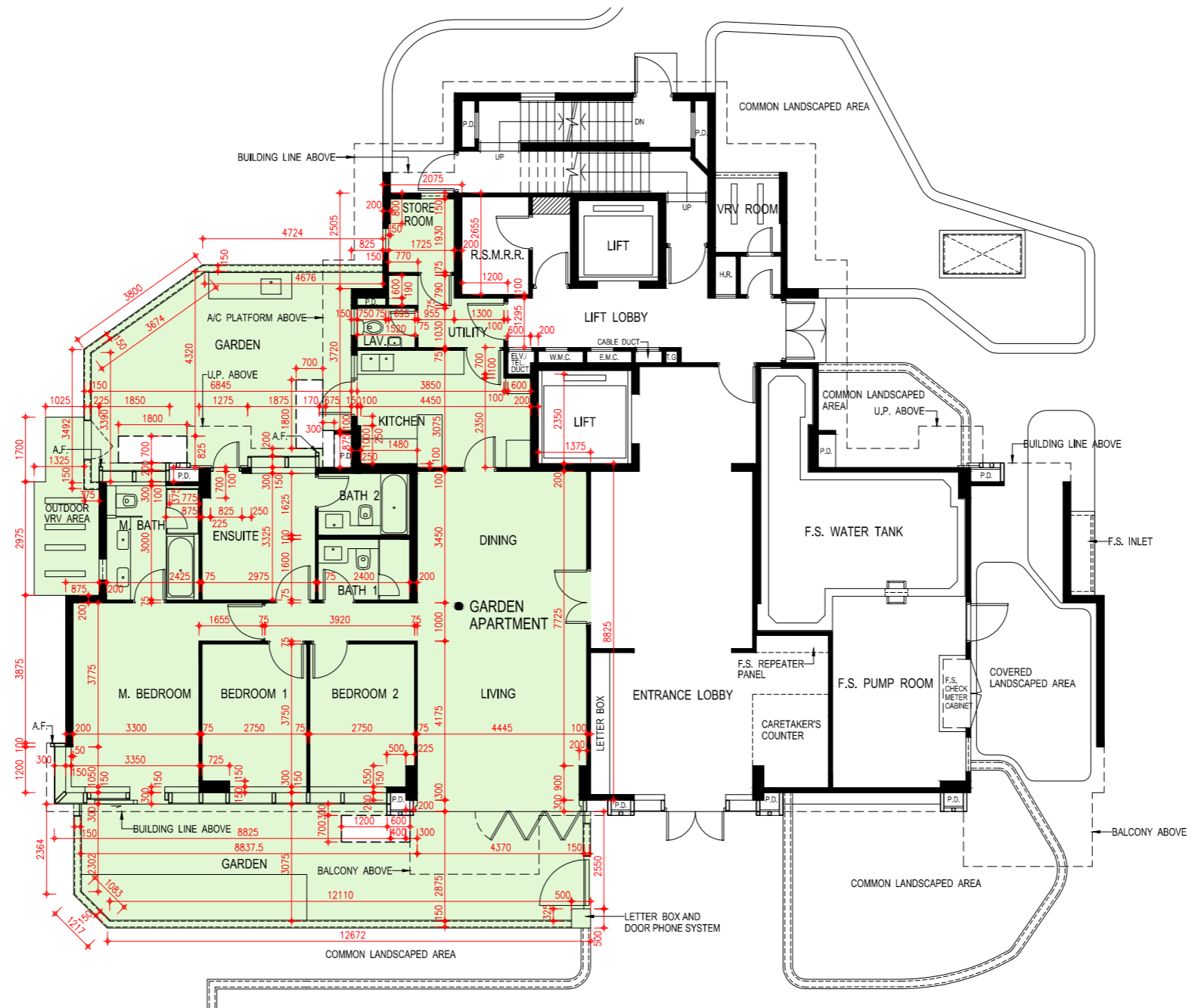
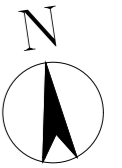

Scale: 0M/米 5M/米  
比例: 1:500

**Tower 8**

**第 8 座**

**1/F Plan**

**1 樓平面圖**

	Tower 8 第8座	
Floor 樓層	1/F 1樓	
Flat 單位	A	B
The thickness of the floor slabs (excluding plaster) of each residential property (mm) 每個住宅物業的樓板(不包括灰泥)的厚度(毫米)	125, 150	125, 150
The floor-to-floor heights of each residential property (mm) 每個住宅物業的層與層之間的高度(毫米)	3150, 3150*	3150, 3150*

The internal areas of the residential properties on the upper floors will generally be slightly larger than those on the lower floors because of the reducing thickness of the structural walls on the upper floors.

因住宅物業的較高樓層的結構牆的厚度遞減，較高樓層的內部面積，一般比較低樓層的內部面積稍大。

Notes:

1. The dimensions of floor plans are all structural dimensions in millimeter.
2. There may be architectural features and/or exposed pipes on external walls of the residential properties. For details, please refer to the latest approved building plans.
3. Common pipes exposed and/or enclosed in cladding are located at/adjacent to flat roof and/or external wall of the residential properties. For details, please refer to the latest approved building plans.
4. There are ceiling bulkheads and/or sunken slab at living/dining room, bedrooms, ensuites, study rooms, utility rooms, store rooms, corridors, bathrooms, powder rooms, lavatories and kitchen of some residential units for the air-conditioning system and/or mechanical and electrical services.
5. Symbols of fittings and fitments shown in the floor plans, such as bathtubs, sink, water closets, shower, sink counter etc are architectural symbols extracted from the latest approved general building plans for general indication only.
6. [\*] Inclusive of the thickness of mass concrete fill on sunken slab.

備註：

1. 平面圖所列之尺寸數字為以毫米標示之建築尺寸。
2. 住宅物業的外牆設有建築裝飾及/或外露喉管。詳細資料請參考最新批准之建築圖則。
3. 住宅物業的平台及/或外牆設有外露及/或外牆裝飾板內藏之公用喉管。詳細資料請參考最新批准的建築圖則。
4. 部份住宅單位的客/飯廳、睡房、套房、書房、工作間、儲物室、走廊、浴室、客廳洗手間、洗手間及廚房有假天花及/或有跌級樓板用以裝置冷氣系統及/或機電設備。
5. 樓面平面圖上所顯示的形象裝置符號，例如浴缸、洗滌盆、坐廁、花灑、洗滌盆櫃乃摘自最新的經批准的建築圖則，並只作一般性標誌。
6. [\*] 包括跌級樓板上之混凝土填充層厚度。

FLOOR PLANS OF RESIDENTIAL PROPERTIES IN THE DEVELOPMENT  
發展項目的住宅物業的樓面平面圖

Tower 8  
第8座

1/F Plan  
1樓平面圖

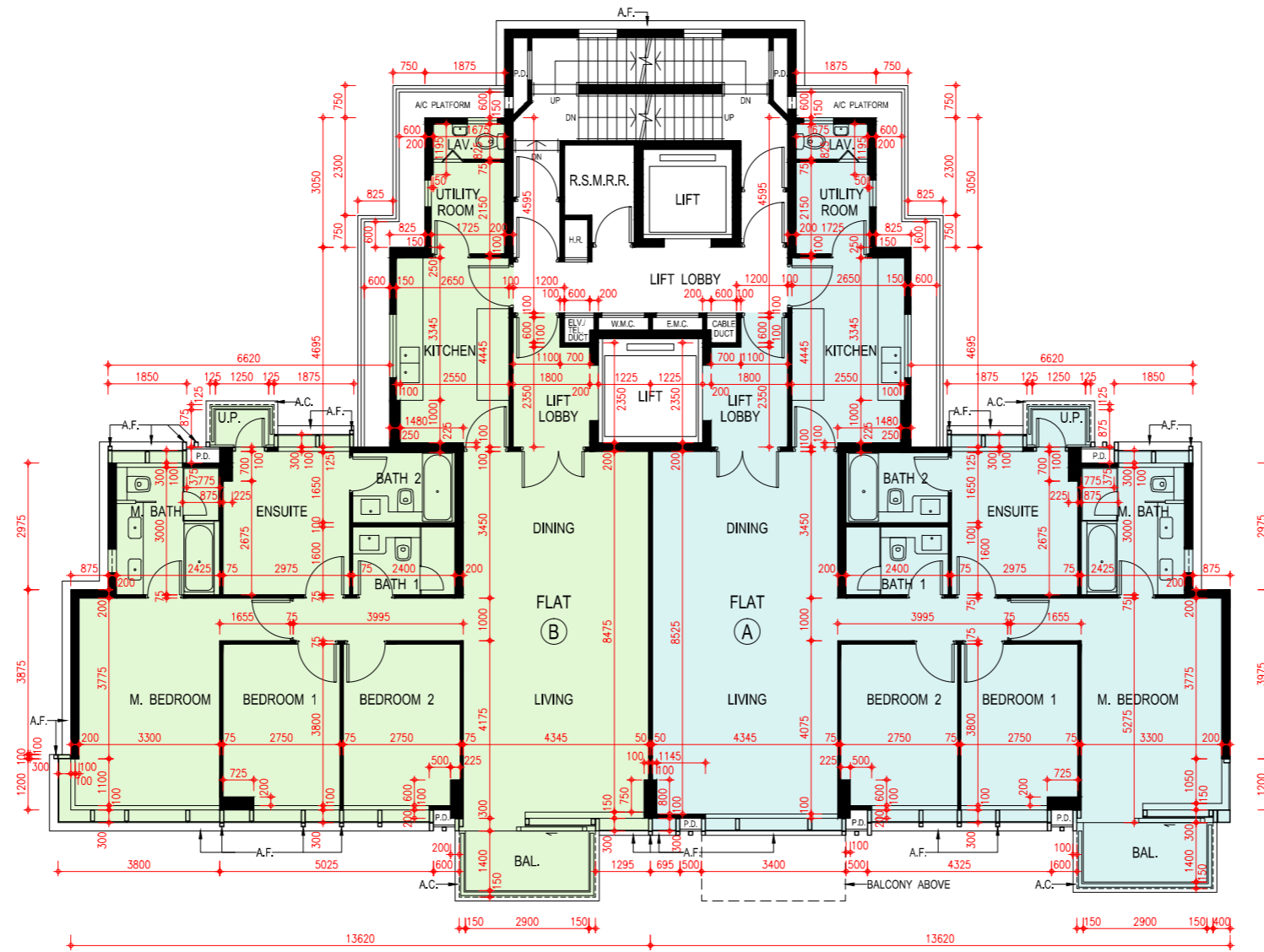
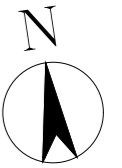

Scale: 0M/米 5M/米  
比例: 5M/米



**Tower 8**

**第 8 座**

**2/F - 8/F, 10/F Plan**

**2樓至8樓，10樓平面圖**

Floor 樓層	Tower 8 第8座			
	2/F-8/F 2樓至8樓		10/F 10樓	
	A	B	A	B
Flat 單位				
The thickness of the floor slabs (excluding plaster) of each residential property (mm) 每個住宅物業的樓板(不包括灰泥)的厚度(毫米)	125, 150	125, 150	125, 150, 175	125, 150, 175
The floor-to-floor heights of each residential property (mm) 每個住宅物業的層與層之間的高度(毫米)	3150, 3150*	3150, 3150*	2750, 2950, 3050, 3150, 3200, 3250, 3300*, 3400*, 3500, 3500*, 3600*, 3700*, 3750*, 3850*	3075, 3200, 3250*, 3425*, 3450*, 3500, 3500*, 3600*, 3725*, 3750*, 3850*

The internal areas of the residential properties on the upper floors will generally be slightly larger than those on the lower floors because of the reducing thickness of the structural walls on the upper floors.

因住宅物業的較高樓層的結構牆的厚度遞減，較高樓層的內部面積，一般比較低樓層的內部面積稍大。

Notes:

- The dimensions of floor plans are all structural dimensions in millimeter.
- There may be architectural features and/or exposed pipes on external walls of the residential properties. For details, please refer to the latest approved building plans.
- Common pipes exposed and/or enclosed in cladding are located at/adjacent to flat roof and/or external wall of the residential properties. For details, please refer to the latest approved building plans.
- There are ceiling bulkheads and/or sunken slab at living/dining room, bedrooms, ensuites, study rooms, utility rooms, store rooms, corridors, bathrooms, powder rooms, lavatories and kitchen of some residential units for the air-conditioning system and/or mechanical and electrical services.
- Symbols of fittings and fitments shown in the floor plans, such as bathtubs, sink, water closets, shower, sink counter etc are architectural symbols extracted from the latest approved general building plans for general indication only.
- 4/F is omitted.
- [\*] Inclusive of the thickness of mass concrete fill on sunken slab.

備註：

- 平面圖所列之尺寸數字為以毫米標示之建築尺寸。
- 住宅物業的外牆設有建築裝飾及/或外露喉管。詳細資料請參考最新批准之建築圖則。
- 住宅物業的平台及/或外牆設有外露及/或外牆裝飾板內藏之公用喉管。詳細資料請參考最新批准的建築圖則。
- 部份住宅單位的客/飯廳、睡房、套房、書房、工作間、儲物室、走廊、浴室、客廳洗手間、洗手間及廚房有假天花及/或有跌級樓板用以裝置冷氣系統及/或機電設備。
- 樓面平面圖上所顯示的形象裝置符號，例如浴缸、洗滌盆、坐廁、花灑、洗滌盆櫃乃摘自最新的經批准的建築圖則，並只作一般性標誌。
- 不設4樓。
- [\*] 包括跌級樓板上之混凝土填充層厚度。

FLOOR PLANS OF RESIDENTIAL PROPERTIES IN THE DEVELOPMENT  
發展項目的住宅物業的樓面平面圖

Tower 8  
第8座

2/F - 8/F, 10/F Plan  
2樓至8樓，10樓平面圖

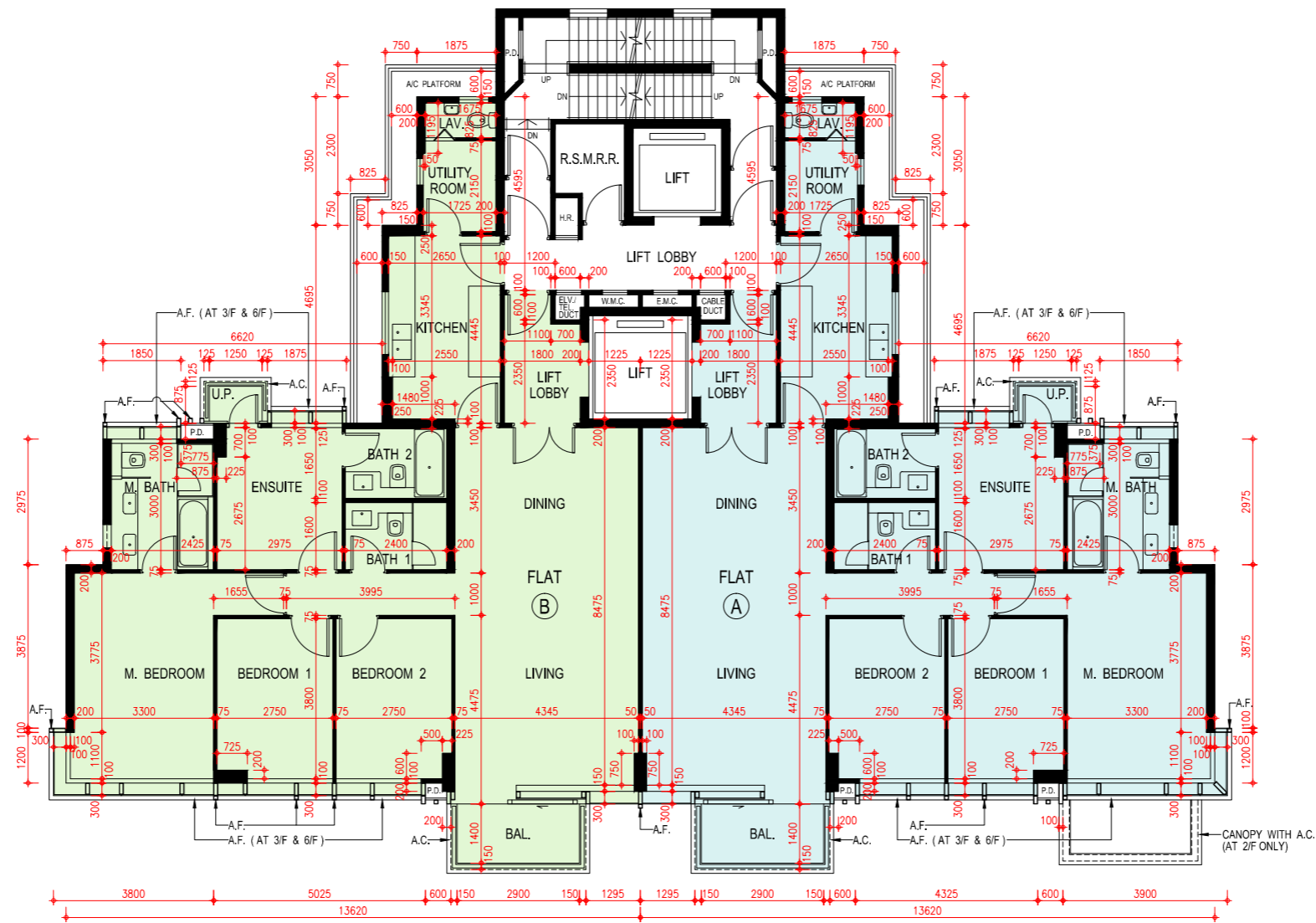
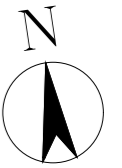

Scale: 0M/米 5M/米  
比例: 140

## FLOOR PLANS OF RESIDENTIAL PROPERTIES IN THE DEVELOPMENT 發展項目的住宅物業的樓面平面圖

### Tower 8 第8座

#### 9/F Plan 9樓平面圖

	Tower 8 第8座	
Floor 樓層	9/F 9樓	
Flat 單位	A	B
The thickness of the floor slabs (excluding plaster) of each residential property (mm) 每個住宅物業的樓板(不包括灰泥)的厚度(毫米)	125, 150	125, 150
The floor-to-floor heights of each residential property (mm) 每個住宅物業的層與層之間的高度(毫米)	3150, 3150*	3150, 3150*

The internal areas of the residential properties on the upper floors will generally be slightly larger than those on the lower floors because of the reducing thickness of the structural walls on the upper floors.

因住宅物業的較高樓層的結構牆的厚度遞減，較高樓層的內部面積，一般比較低樓層的內部面積稍大。

#### Notes:

- The dimensions of floor plans are all structural dimensions in millimeter.
- There may be architectural features and/or exposed pipes on external walls of the residential properties. For details, please refer to the latest approved building plans.
- Common pipes exposed and/or enclosed in cladding are located at/adjacent to flat roof and/or external wall of the residential properties. For details, please refer to the latest approved building plans.
- There are ceiling bulkheads and/or sunken slab at living/dining room, bedrooms, ensuites, study rooms, utility rooms, store rooms, corridors, bathrooms, powder rooms, lavatories and kitchen of some residential units for the air-conditioning system and/or mechanical and electrical services.
- Symbols of fittings and fitments shown in the floor plans, such as bathtubs, sink, water closets, shower, sink counter etc are architectural symbols extracted from the latest approved general building plans for general indication only.
- [\*] Inclusive of the thickness of mass concrete fill on sunken slab.
- Flat B on 9/F of Tower 8 has been altered by way of minor works or exempted works under the Buildings Ordinance after the completion of the Development. The latest condition of which is shown on the relevant floor plans. The alterations are as follows:  
A. Adjustments have been made to the door of Lavatory altered.

#### 備註：

- 平面圖所列之尺寸數字為以毫米標示之建築尺寸。
- 住宅物業的外牆設有建築裝飾及/或外露喉管。詳細資料請參考最新批准之建築圖則。
- 住宅物業的平台及/或外牆設有外露及/或外牆裝飾板內藏之公用喉管。詳細資料請參考最新批准的建築圖則。
- 部份住宅單位的客/飯廳、睡房、套房、書房、工作間、儲物室、走廊、浴室、客廳洗手間、洗手間及廚房有假天花及/或有跌級樓板用以裝置冷氣系統及/或機電設備。
- 樓面平面圖上所顯示的形象裝置符號，例如浴缸、洗滌盆、坐廁、花灑、洗滌盆櫃乃摘自最新的經批准的建築圖則，並只作一般性標誌。
- [\*] 包括跌級樓板上之混凝土填充層厚度。
- 第8座9樓B單位在發展項目落成後進行小型工程或獲《建築物條例》豁免的工程而有所改動。現狀請參考有關平面圖，該改動如下：  
A. 洗手間的門已被改動。

FLOOR PLANS OF RESIDENTIAL PROPERTIES IN THE DEVELOPMENT  
 發展項目的住宅物業的樓面平面圖

Tower 8  
 第8座

9/F Plan  
 9樓平面圖

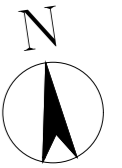

As-is Part Plan of 9/F  
 (See Notes 7A)  
 9樓之部份現狀圖  
 (見備註7A)

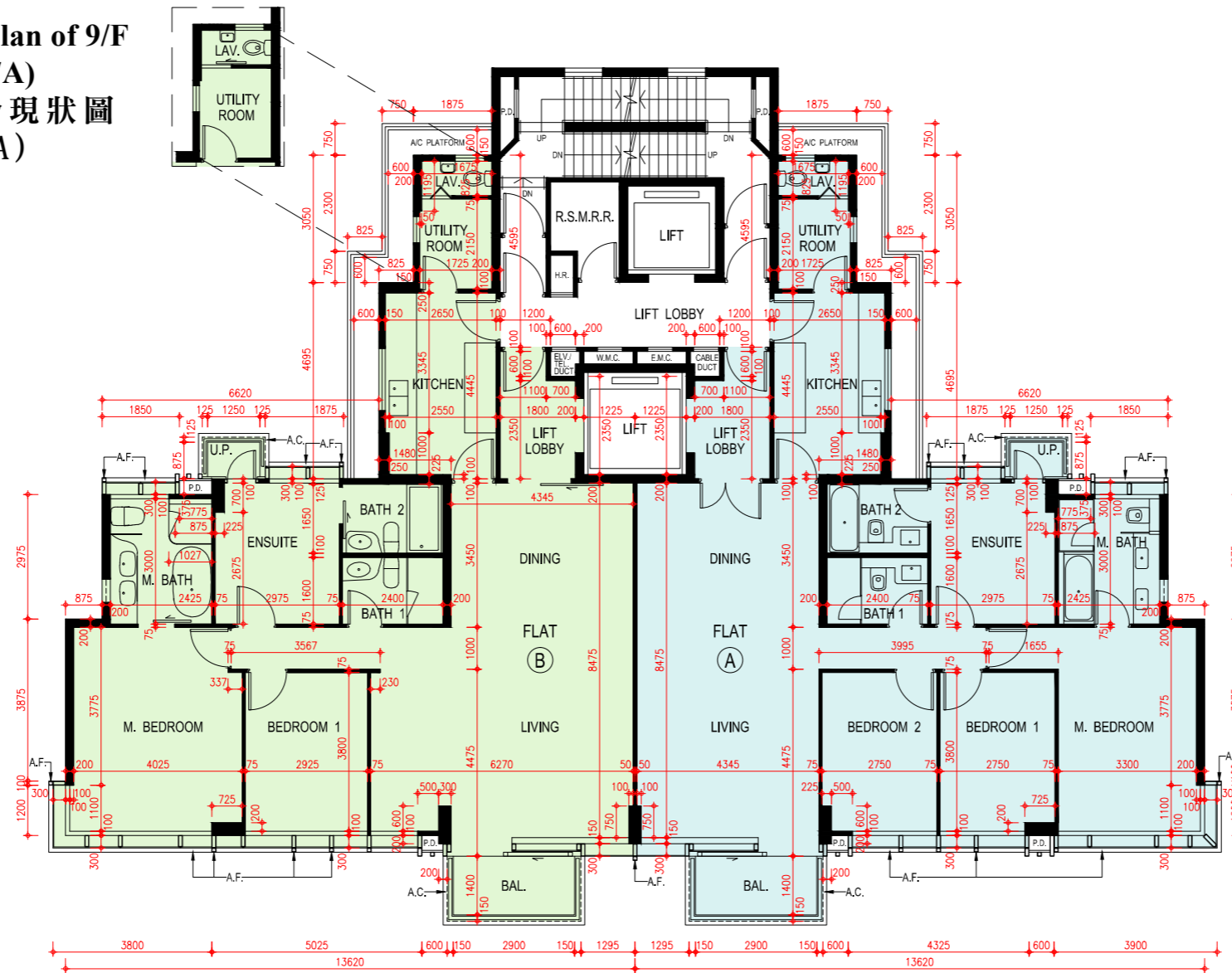

Scale: 0M/米 5M/米  
 比例: 5M/米

**Tower 8**

**第 8 座**

**11/F Plan**

**11 樓平面圖**

	Tower 8 第8座
Floor 樓層	11/F 11樓
Flat 單位	• Courtyard Penthouse
The thickness of the floor slabs (excluding plaster) of each residential property (mm) 每個住宅物業的樓板(不包括灰泥)的厚度(毫米)	150, 175
The floor-to-floor heights of each residential property (mm) 每個住宅物業的層與層之間的高度(毫米)	3500, 3550*, 3750*, 3850*, 3925*, 3950*, 4050*

The internal areas of the residential properties on the upper floors will generally be slightly larger than those on the lower floors because of the reducing thickness of the structural walls on the upper floors.

因住宅物業的較高樓層的結構牆的厚度遞減，較高樓層的內部面積，一般比較低樓層的內部面積稍大。

Notes:

- The dimensions of floor plans are all structural dimensions in millimeter.
- There may be architectural features and/or exposed pipes on external walls of the residential properties. For details, please refer to the latest approved building plans.
- Common pipes exposed and/or enclosed in cladding are located at/adjacent to flat roof and/or external wall of the residential properties. For details, please refer to the latest approved building plans.
- There are ceiling bulkheads and/or sunken slab at living/dining room, bedrooms, ensuites, study rooms, utility rooms, store rooms, corridors, bathrooms, powder rooms, lavatories and kitchen of some residential units for the air-conditioning system and/or mechanical and electrical services.
- Symbols of fittings and fitments shown in the floor plans, such as bathtubs, sink, water closets, shower, sink counter etc are architectural symbols extracted from the latest approved general building plans for general indication only.
- “Terrace Apartment”, “Garden Apartment” and “Courtyard Penthouse” are names for marketing purposes only and will not appear in any Deed of Mutual Covenant, the Preliminary Agreement for Sale and Purchase, Agreement for Sale and Purchase, Assignment, or any other title deeds and documents relating to the Development. The names as appearing on the approved building plans are: Flat A on 1/F of Tower 1 for Terrace Apartment on 1/F of Tower 1; Flat B on G/F of Tower 2 for Garden Apartment on G/F of Tower 2; Flat B on G/F of Tower 3 for Garden Apartment on G/F of Tower 3; Flat A on G/F of Tower 7 for Garden Apartment on G/F of Tower 7; Penthouse on 11/F of Tower 7 for Courtyard Penthouse on 11/F of Tower 7; Flat B on G/F of Tower 8 for Garden Apartment on G/F of Tower 8; Penthouse on 11/F of Tower 8 for Courtyard Penthouse on 11/F of Tower 8.
- [\*] Inclusive of the thickness of mass concrete fill on sunken slab.

備註：

- 平面圖所列之尺寸數字為以毫米標示之建築尺寸。
- 住宅物業的外牆設有建築裝飾及/或外露喉管。詳細資料請參考最新批准之建築圖則。
- 住宅物業的平台及/或外牆設有外露及/或外牆裝飾板內藏之公用喉管。詳細資料請參考最新批准的建築圖則。
- 部份住宅單位的客/飯廳、睡房、套房、書房、工作間、儲物室、走廊、浴室、客廳洗手間、洗手間及廚房有假天花及/或有跌級樓板用以裝置冷氣系統及/或機電設備。
- 樓面平面圖上所顯示的形象裝置符號，例如浴缸、洗滌盆、坐廁、花灑、洗滌盆櫃乃摘自最新的經批准的建築圖則，並只作一般性標誌。
- 「Terrace Apartment」、「Garden Apartment」及「Courtyard Penthouse」僅為市場推廣之用的名稱，並不會於關於發展項目的任何公契、臨時買賣合約、買賣合約、轉讓契及契據出現。經批准的建築圖則上顯示的名稱為：第1座1樓A單位（即第1座1樓Terrace Apartment）；第2座地下B單位（即第2座地下Garden Apartment）；第3座地下B單位（即第3座地下Garden Apartment）；第7座地下A單位（即第7座地下Garden Apartment）；第7座11樓Penthouse（即第7座11樓Courtyard Penthouse）；第8座地下B單位（即第8座地下Garden Apartment）；第8座11樓Penthouse（即第8座11樓Courtyard Penthouse）。
- [\*] 包括跌級樓板上之混凝土填充層厚度。



FLOOR PLANS OF RESIDENTIAL PROPERTIES IN THE DEVELOPMENT  
發展項目的住宅物業的樓面平面圖

Tower 8  
第8座

11/F Plan  
11樓平面圖

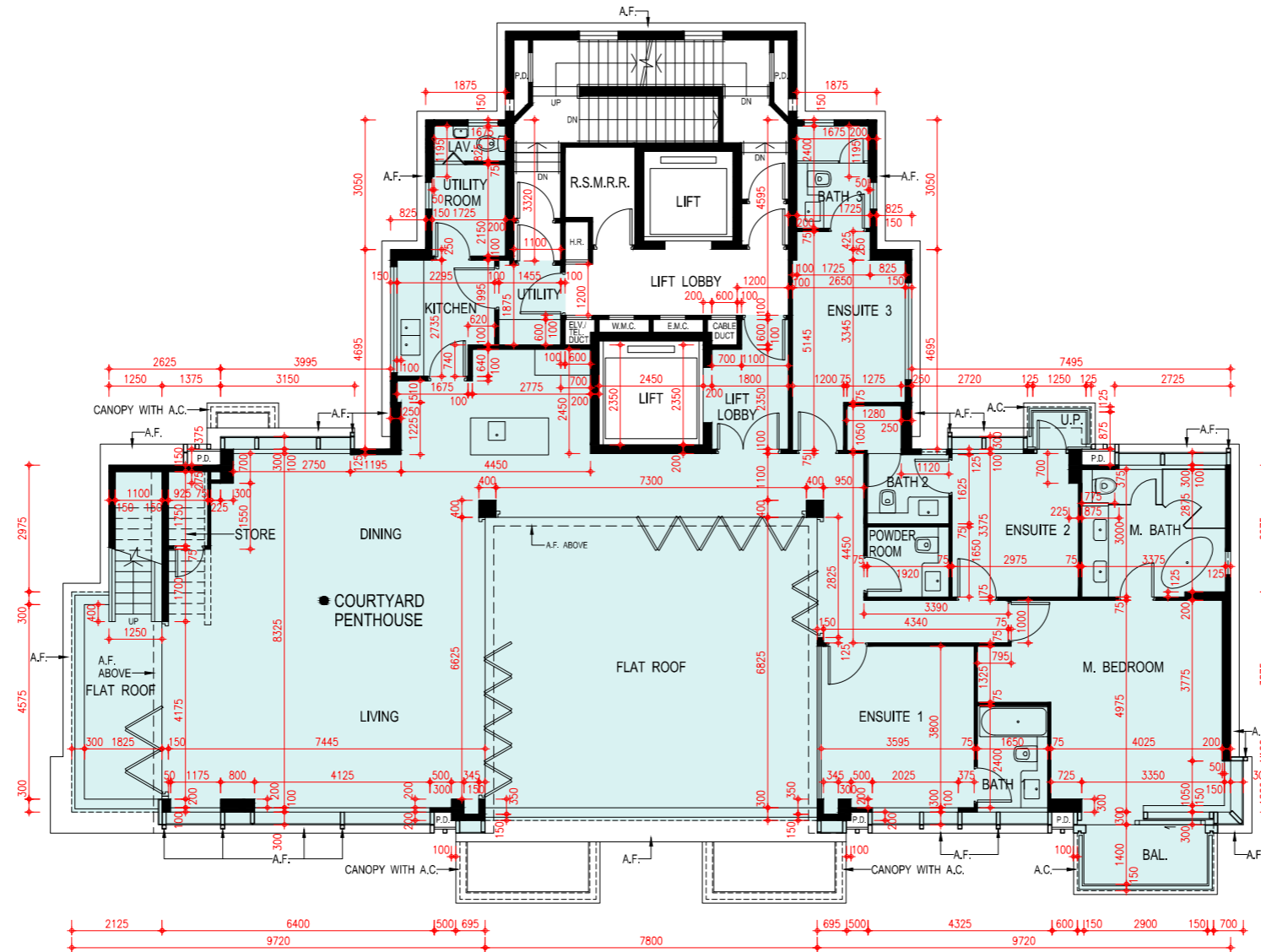
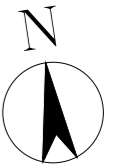

Scale: 0M/米 5M/米  
比例: 5M/米

**Tower 8**

**第8座**

**Roof Floor Plan**

**天台平面圖**

	Tower 8 第8座
Floor 樓層	Roof 天台
Flat 單位	• Courtyard Penthouse
The thickness of the floor slabs (excluding plaster) of each residential property (mm) 每個住宅物業的樓板(不包括灰泥)的厚度(毫米)	Not Applicable 不適用
The floor-to-floor heights of each residential property (mm) 每個住宅物業的層與層之間的高度(毫米)	Not Applicable 不適用

The internal areas of the residential properties on the upper floors will generally be slightly larger than those on the lower floors because of the reducing thickness of the structural walls on the upper floors.

因住宅物業的較高樓層的結構牆的厚度遞減，較高樓層的內部面積，一般比較低樓層的內部面積稍大。

Notes:

1. The dimensions of floor plans are all structural dimensions in millimeter.
2. There may be architectural features and/or exposed pipes on external walls of the residential properties. For details, please refer to the latest approved building plans.
3. Common pipes exposed and/or enclosed in cladding are located at/adjacent to flat roof and/or external wall of the residential properties. For details, please refer to the latest approved building plans.
4. There are ceiling bulkheads and/or sunken slab at living/dining room, bedrooms, ensuites, study rooms, utility rooms, store rooms, corridors, bathrooms, powder rooms, lavatories and kitchen of some residential units for the air-conditioning system and/or mechanical and electrical services.
5. Symbols of fittings and fitments shown in the floor plans, such as bathtubs, sink, water closets, shower, sink counter etc are architectural symbols extracted from the latest approved general building plans for general indication only.
6. • "Terrace Apartment", "Garden Apartment" and "Courtyard Penthouse" are names for marketing purposes only and will not appear in any Deed of Mutual Covenant, the Preliminary Agreement for Sale and Purchase, Agreement for Sale and Purchase, Assignment, or any other title deeds and documents relating to the Development. The names as appearing on the approved building plans are: Flat A on 1/F of Tower 1 for Terrace Apartment on 1/F of Tower 1; Flat B on G/F of Tower 2 for Garden Apartment on G/F of Tower 2; Flat B on G/F of Tower 3 for Garden Apartment on G/F of Tower 3; Flat A on G/F of Tower 7 for Garden Apartment on G/F of Tower 7; Penthouse on 11/F of Tower 7 for Courtyard Penthouse on 11/F of Tower 7; Flat B on G/F of Tower 8 for Garden Apartment on G/F of Tower 8; Penthouse on 11/F of Tower 8 for Courtyard Penthouse on 11/F of Tower 8.

備註：

1. 平面圖所列之尺寸數字為以毫米標示之建築尺寸。
2. 住宅物業的外牆設有建築裝飾及/或外露喉管。詳細資料請參考最新批准之建築圖則。
3. 住宅物業的平台及/或外牆設有外露及/或外牆裝飾板內藏之公用喉管。詳細資料請參考最新批准的建築圖則。
4. 部份住宅單位的客/飯廳、睡房、套房、書房、工作間、儲物室、走廊、浴室、客廳洗手間、洗手間及廚房有假天花及/或有跌級樓板用以裝置冷氣系統及/或機電設備。
5. 樓面平面圖上所顯示的形象裝置符號，例如浴缸、洗滌盆、坐廁、花灑、洗滌盆櫃乃摘自最新的經批准的建築圖則，並只作一般性標誌。
6. • 「Terrace Apartment」、「Garden Apartment」及「Courtyard Penthouse」僅為市場推廣之用的名稱，並不會於關於發展項目的任何公契、臨時買賣合約、買賣合約、轉讓契及契據出現。經批准的建築圖則上顯示的名稱為：第1座1樓A單位（即第1座1樓Terrace Apartment）；第2座地下B單位（即第2座地下Garden Apartment）；第3座地下B單位（即第3座地下Garden Apartment）；第7座地下A單位（即第7座地下Garden Apartment）；第7座11樓Penthouse（即第7座11樓Courtyard Penthouse）；第8座地下B單位（即第8座地下Garden Apartment）；第8座11樓Penthouse（即第8座11樓Courtyard Penthouse）。

Tower 8  
 第8座

Roof Floor Plan  
 天台平面圖

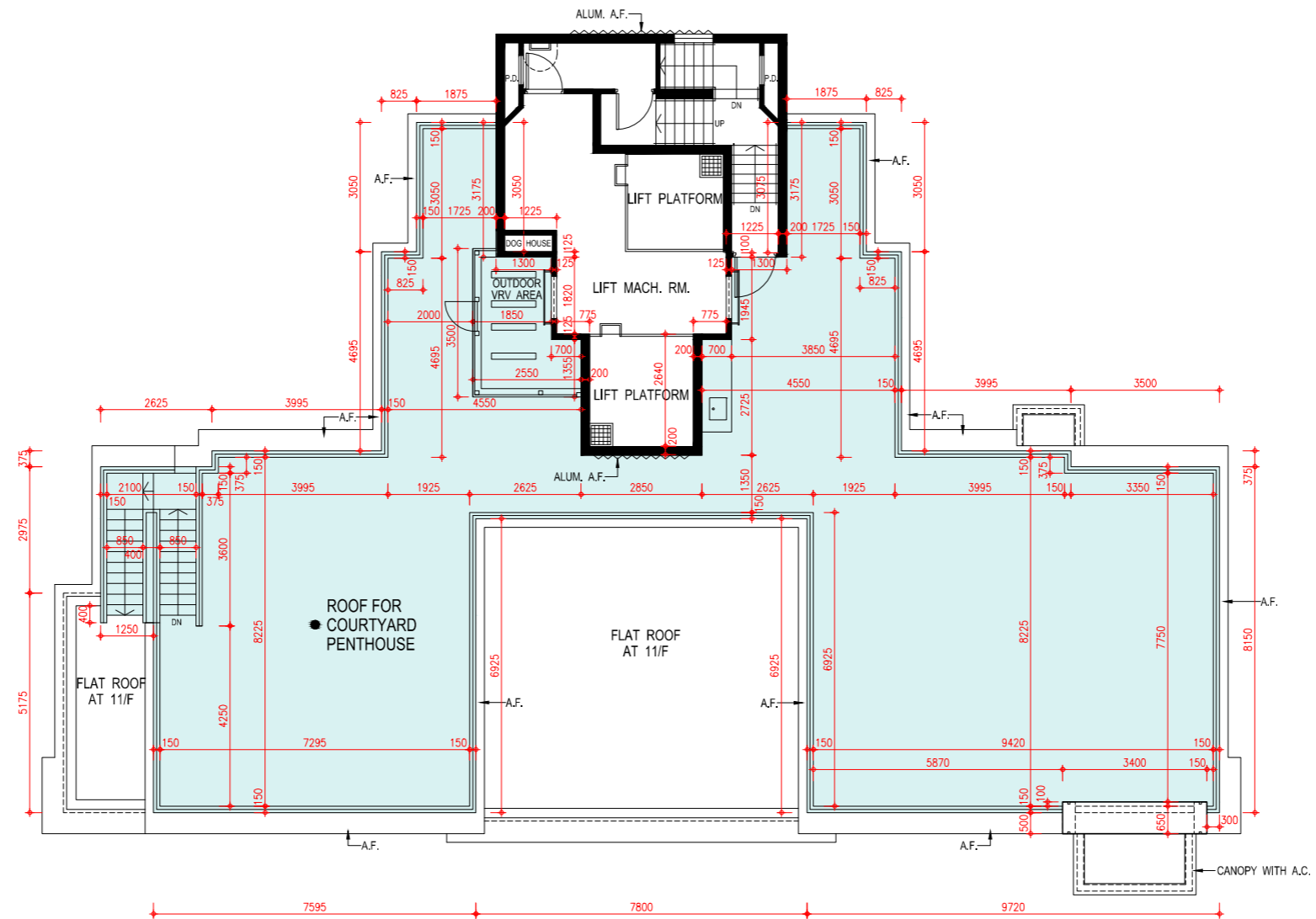
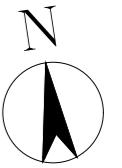

## AREA OF RESIDENTIAL PROPERTIES IN THE DEVELOPMENT

### 發展項目中的住宅物業的面積

Description of Residential Property 物業的描述	Saleable Area (including balcony, utility platform and verandah, if any) sq. metre (sq. ft.) 實用面積 (包括露台、工作平台及陽台(如有)) 平方米 (平方呎)	Area of other specified items (Not included in the Saleable Area) 其他指明項目的面積 (不計算入實用面積)									
		Air-conditioning plant room 空調機房	Bay window 窗台	Cockloft 閣樓	Flat Roof 平台	Garden 花園	Parking Space 停車位	Roof 天台	Stairhood 梯屋	Terrace 前庭	Yard 庭院
House 1 1號洋房	256.298 (2759) Balcony 露台: 4.568 (49) Utility Platform 工作平台: - Verandah 陽台: -	-	-	-	6.616 (71)	127.814 (1376)	-	50.697 (546)	6.292 (68)	-	-
House 2 2號洋房	256.298 (2759) Balcony 露台: 4.568 (49) Utility Platform 工作平台: - Verandah 陽台: -	-	-	-	6.616 (71)	78.874 (849)	-	50.697 (546)	6.292 (68)	-	-
House 3 3號洋房	256.278 (2759) Balcony 露台: 4.568 (49) Utility Platform 工作平台: - Verandah 陽台: -	-	-	-	6.616 (71)	81.009 (872)	-	50.697 (546)	6.292 (68)	-	-
House 5 5號洋房	256.278 (2759) Balcony 露台: 4.568 (49) Utility Platform 工作平台: - Verandah 陽台: -	-	-	-	6.616 (71)	75.959 (818)	-	50.697 (546)	6.292 (68)	-	-
House 6 6號洋房	256.278 (2759) Balcony 露台: 4.568 (49) Utility Platform 工作平台: - Verandah 陽台: -	-	-	-	6.616 (71)	77.559 (835)	-	50.697 (546)	6.292 (68)	-	-
House 7 7號洋房	256.278 (2759) Balcony 露台: 4.568 (49) Utility Platform 工作平台: - Verandah 陽台: -	-	-	-	6.616 (71)	81.740 (880)	-	50.697 (546)	6.292 (68)	-	-
House 8 8號洋房	207.452 (2233) Balcony 露台: 5.593 (60) Utility Platform 工作平台: - Verandah 陽台: -	-	-	-	5.090 (55)	71.256 (767)	-	36.503 (393)	10.849 (117)	-	-
House 9 9號洋房	207.452 (2233) Balcony 露台: 5.593 (60) Utility Platform 工作平台: - Verandah 陽台: -	-	-	-	5.090 (55)	46.510 (501)	-	36.503 (393)	10.849 (117)	-	-
House 10 10號洋房	207.452 (2233) Balcony 露台: 5.593 (60) Utility Platform 工作平台: - Verandah 陽台: -	-	-	-	5.090 (55)	61.132 (658)	-	36.503 (393)	10.849 (117)	-	-

The saleable area of each residential property and the floor area of every balcony, utility platform or verandah (if any) to the extent that it forms part of the residential property are calculated in accordance with Section 8 of the Residential Properties (First-hand Sales) Ordinance. The area of other specified items to the extent that it forms part of the residential property (not included in the saleable area) is calculated in accordance with Part 2 of Schedule 2 to the Residential Properties (First-hand Sales) Ordinance.

Notes:

- The areas as specified above in square feet are converted from the area in square metre at a rate of 1 square metre = 10.764 square feet and rounded off to the nearest whole square foot, which may be slightly different from the area presented in square metres.
- There is no verandah in the residential properties of the Development.

每個住宅物業的實用面積以及構成住宅物業的一部分的範圍內每一露台、工作平台或陽台(如有)的樓面面積,是按照《一手住宅物業銷售條例》第8條計算得出的。構成住宅物業的一部分的其他指明項目的面積(不計算入實用面積)是按照《一手住宅物業銷售條例》附表2第2部計算得出的。

備註:

- 上述以平方呎表述之面積由以平方米表述之面積以1平方米 = 10.764平方呎換算並以四捨五入至整數平方呎之方法計算得出,與以平方米表述之面積可能有些微差異。
- 發展項目住宅物業並無陽台。

## AREA OF RESIDENTIAL PROPERTIES IN THE DEVELOPMENT

### 發展項目中的住宅物業的面積

Description of Residential Property 物業的描述	Saleable Area (including balcony, utility platform and verandah, if any) sq. metre (sq. ft.) 實用面積 (包括露台、工作平台及陽台(如有)) 平方米 (平方呎)	Area of other specified items (Not included in the Saleable Area) 其他指明項目的面積 (不計算入實用面積)									
		Air-conditioning plant room 空調機房	Bay window 窗台	Cockloft 閣樓	Flat Roof 平台	Garden 花園	Parking Space 停車位	Roof 天台	Stairhood 梯屋	Terrace 前庭	Yard 庭院
House 11 11號洋房	298.444 (3212) Balcony 露台: 5.836 (63) Utility Platform 工作平台: - Verandah 陽台: -	-	-	-	8.997 (97)	93.521 (1007)	-	56.836 (612)	6.387 (69)	-	-
House 12 12號洋房	339.536 (3655) Balcony 露台: 4.785 (52) Utility Platform 工作平台: - Verandah 陽台: -	-	-	-	-	156.725 (1687)	-	73.050 (786)	8.136 (88)	-	-
House 15 15號洋房	281.437 (3029) Balcony 露台: 4.568 (49) Utility Platform 工作平台: - Verandah 陽台: -	-	-	-	6.616 (71)	79.074 (851)	-	54.331 (585)	6.914 (74)	-	-
House 16 16號洋房	281.182 (3027) Balcony 露台: 4.568 (49) Utility Platform 工作平台: - Verandah 陽台: -	-	-	-	6.616 (71)	97.476 (1049)	-	54.331 (585)	6.914 (74)	-	-
House 17 17號洋房	281.182 (3027) Balcony 露台: 4.568 (49) Utility Platform 工作平台: - Verandah 陽台: -	-	-	-	6.616 (71)	115.274 (1241)	-	54.331 (585)	6.914 (74)	-	-
House 18 18號洋房	281.097 (3026) Balcony 露台: 4.568 (49) Utility Platform 工作平台: - Verandah 陽台: -	-	-	-	6.616 (71)	134.664 (1450)	-	54.331 (585)	6.914 (74)	-	-
House 19 19號洋房	279.712 (3011) Balcony 露台: 4.568 (49) Utility Platform 工作平台: - Verandah 陽台: -	-	-	-	6.616 (71)	151.625 (1632)	-	54.331 (585)	6.914 (74)	-	-
House 20 20號洋房	280.924 (3024) Balcony 露台: 4.568 (49) Utility Platform 工作平台: - Verandah 陽台: -	-	-	-	6.616 (71)	170.350 (1834)	-	54.331 (585)	6.914 (74)	-	-

The saleable area of each residential property and the floor area of every balcony, utility platform or verandah (if any) to the extent that it forms part of the residential property are calculated in accordance with Section 8 of the Residential Properties (First-hand Sales) Ordinance. The area of other specified items to the extent that it forms part of the residential property (not included in the saleable area) is calculated in accordance with Part 2 of Schedule 2 to the Residential Properties (First-hand Sales) Ordinance.

Notes:

- The areas as specified above in square feet are converted from the area in square metre at a rate of 1 square metre = 10.764 square feet and rounded off to the nearest whole square foot, which may be slightly different from the area presented in square metres.
- There is no verandah in the residential properties of the Development.

每個住宅物業的實用面積以及構成住宅物業的一部分的範圍內每一露台、工作平台或陽台(如有)的樓面面積,是按照《一手住宅物業銷售條例》第8條計算得出的。構成住宅物業的一部分的其他指明項目的面積(不計算入實用面積)是按照《一手住宅物業銷售條例》附表2第2部計算得出的。

備註:

- 上述以平方呎表述之面積由以平方米表述之面積以1平方米 = 10.764平方呎換算並以四捨五入至整數平方呎之方法計算得出,與以平方米表述之面積可能有些微差異。
- 發展項目住宅物業並無陽台。



## AREA OF RESIDENTIAL PROPERTIES IN THE DEVELOPMENT

### 發展項目中的住宅物業的面積

Description of Residential Property 物業的描述	Saleable Area (including balcony, utility platform and verandah, if any) sq. metre (sq. ft.) 實用面積 (包括露台、工作平台及陽台(如有)) 平方米 (平方呎)	Area of other specified items (Not included in the Saleable Area) 其他指明項目的面積 (不計算入實用面積)									
		Air-conditioning plant room 空調機房	Bay window 窗台	Cockloft 閣樓	Flat Roof 平台	Garden 花園	Parking Space 停車位	Roof 天台	Stairhood 梯屋	Terrace 前庭	Yard 庭院
House 21 21號洋房	281.112 (3026) Balcony 露台: 4.568 (49) Utility Platform 工作平台: - Verandah 陽台: -	-	-	-	6.616 (71)	185.956 (2002)	-	54.331 (585)	6.914 (74)	-	-
House 22 22號洋房	281.089 (3026) Balcony 露台: 4.568 (49) Utility Platform 工作平台: - Verandah 陽台: -	-	-	-	6.616 (71)	201.408 (2168)	-	54.331 (585)	6.914 (74)	-	-
House 23 23號洋房	460.793 (4960) Balcony 露台: 5.655 (61) Utility Platform 工作平台: - Verandah 陽台: -	-	-	-	29.328 (316)	516.780 (5563)	-	95.750 (1031)	8.126 (87)	-	-
House 25 25號洋房	239.291 (2576) Balcony 露台: 4.568 (49) Utility Platform 工作平台: - Verandah 陽台: -	-	-	-	6.616 (71)	72.273 (778)	-	49.487 (533)	6.291 (68)	-	-
House 26 26號洋房	239.291 (2576) Balcony 露台: 4.568 (49) Utility Platform 工作平台: - Verandah 陽台: -	-	-	-	6.616 (71)	72.264 (778)	-	49.487 (533)	6.291 (68)	-	-
House 27 27號洋房	239.291 (2576) Balcony 露台: 4.568 (49) Utility Platform 工作平台: - Verandah 陽台: -	-	-	-	6.616 (71)	72.224 (777)	-	49.487 (533)	6.291 (68)	-	-
House 28 28號洋房	240.061 (2584) Balcony 露台: 4.568 (49) Utility Platform 工作平台: - Verandah 陽台: -	-	-	-	6.616 (71)	75.841 (816)	-	49.487 (533)	6.291 (68)	-	-

The saleable area of each residential property and the floor area of every balcony, utility platform or verandah (if any) to the extent that it forms part of the residential property are calculated in accordance with Section 8 of the Residential Properties (First-hand Sales) Ordinance. The area of other specified items to the extent that it forms part of the residential property (not included in the saleable area) is calculated in accordance with Part 2 of Schedule 2 to the Residential Properties (First-hand Sales) Ordinance.

Notes:

- The areas as specified above in square feet are converted from the area in square metre at a rate of 1 square metre = 10.764 square feet and rounded off to the nearest whole square foot, which may be slightly different from the area presented in square metres.
- There is no verandah in the residential properties of the Development.

每個住宅物業的實用面積以及構成住宅物業的一部分的範圍內每一露台、工作平台或陽台(如有)的樓面面積,是按照《一手住宅物業銷售條例》第8條計算得出的。構成住宅物業的一部分的其他指明項目的面積(不計算入實用面積)是按照《一手住宅物業銷售條例》附表2第2部計算得出的。

備註:

- 上述以平方呎表述之面積由以平方米表述之面積以1平方米 = 10.764平方呎換算並以四捨五入至整數平方呎之方法計算得出,與以平方米表述之面積可能有些微差異。
- 發展項目住宅物業並無陽台。

## AREA OF RESIDENTIAL PROPERTIES IN THE DEVELOPMENT

### 發展項目中的住宅物業的面積

Description of Residential Property 物業的描述			Saleable Area (including balcony, utility platform and verandah, if any) sq. metre (sq. ft.) 實用面積 (包括露台、工作平台及陽台(如有)) 平方米(平方呎)	Area of other specified items (Not included in the Saleable Area) 其他指明項目的面積(不計算入實用面積) sq. metre (sq. ft.) 平方米(平方呎)									
BlockName 大廈名稱	Floor 樓層	Flat 單位		Air-conditioning plant room 空調機房	Bay window 窗台	Cockloft 閣樓	Flat Roof 平台	Garden 花園	Parking Space 停車位	Roof 天台	Stairhood 梯屋	Terrace 前庭	Yard 庭院
Tower 1 第1座	G/F - 1/F 地下至1樓	Garden Duplex	293.747 (3162) Balcony 露台: 6.000 (65) Utility Platform 工作平台: - Verandah 陽台: -	-	-	-	8.228 (89)	86.926 (936)	-	-	-	-	-
	1/F 1樓	• Terrace Apartment	188.227 (2026) Balcony 露台: 6.000 (65) Utility Platform 工作平台: - Verandah 陽台: -	-	-	-	82.684 (890)	-	-	-	-	-	-
	2/F - 3/F & 5/F - 10/F 2樓至3樓及 5樓至10樓	A	189.727 (2042) Balcony 露台: 6.000 (65) Utility Platform 工作平台: 1.500 (16) Verandah 陽台: -	-	-	-	-	-	-	-	-	-	-
	2/F - 3/F & 5/F - 9/F 2樓至3樓及 5樓至9樓	B	187.930 (2023) Balcony 露台: 6.000 (65) Utility Platform 工作平台: 1.500 (16) Verandah 陽台: -	-	-	-	-	-	-	-	-	-	-
	10/F 10樓	B	188.857 (2033) Balcony 露台: 6.000 (65) Utility Platform 工作平台: 1.500 (16) Verandah 陽台: -	-	-	-	-	-	-	-	-	-	-
	11/F 11樓	Sky Pool Penthouse	247.023 (2659) Balcony 露台: 6.000 (65) Utility Platform 工作平台: 1.500 (16) Verandah 陽台: -	-	-	-	102.396 (1102)	-	-	212.180 (2284)	-	-	-

The saleable area of each residential property and the floor area of every balcony, utility platform or verandah (if any) to the extent that it forms part of the residential property are calculated in accordance with Section 8 of the Residential Properties (First-hand Sales) Ordinance. The area of other specified items to the extent that it forms part of the residential property (not included in the saleable area) is calculated in accordance with Part 2 of Schedule 2 to the Residential Properties (First-hand Sales) Ordinance.

#### Notes:

- The areas as specified above in square feet are converted from the area in square metre at a rate of 1 square metre = 10.764 square feet and rounded off to the nearest whole square foot, which may be slightly different from the area presented in square metres.
- There is no verandah in the residential properties of the Development.
- “Terrace Apartment”, “Garden Apartment” and “Courtyard Penthouse” are names for marketing purposes only and will not appear in any Deed of Mutual Covenant, the Preliminary Agreement for Sale and Purchase, Agreement for Sale and Purchase, Assignment, or any other title deeds and documents relating to the Development. The names as appearing on the approved building plans are: Flat A on 1/F of Tower 1 for Terrace Apartment on 1/F of Tower 1; Flat B on G/F of Tower 2 for Garden Apartment on G/F of Tower 2; Flat B on G/F of Tower 3 for Garden Apartment on G/F of Tower 3; Flat A on G/F of Tower 7 for Garden Apartment on G/F of Tower 7; Penthouse on 11/F of Tower 7 for Courtyard Penthouse on 11/F of Tower 7; Flat B on G/F of Tower 8 for Garden Apartment on G/F of Tower 8; Penthouse on 11/F of Tower 8 for Courtyard Penthouse on 11/F of Tower 8.

每個住宅物業的實用面積以及構成住宅物業的一部分的範圍內每一露台、工作平台或陽台(如有)的樓面面積,是按照《一手住宅物業銷售條例》第8條計算得出的。構成住宅物業的一部分的其他指明項目的面積(不計算入實用面積)是按照《一手住宅物業銷售條例》附表2第2部計算得出的。

#### 備註:

- 上述以平方呎表述之面積由以平方米表述之面積以1平方米 = 10.764平方呎換算並以四捨五入至整數平方呎之方法計算得出,與以平方米表述之面積可能有些微差異。
- 發展項目住宅物業並無陽台。
- 「Terrace Apartment」、「Garden Apartment」及「Courtyard Penthouse」僅為市場推廣之用的名稱,並不會於關於發展項目的任何公契、臨時買賣合約、買賣合約、轉讓契及契據出現。經批准的建築圖則上顯示的名稱為:第1座1樓A單位(即第1座1樓Terrace Apartment);第2座地下B單位(即第2座地下Garden Apartment);第3座地下B單位(即第3座地下Garden Apartment);第7座地下A單位(即第7座地下Garden Apartment);第7座11樓Penthouse(即第7座11樓Courtyard Penthouse);第8座地下B單位(即第8座地下Garden Apartment);第8座11樓Penthouse(即第8座11樓Courtyard Penthouse)。

## AREA OF RESIDENTIAL PROPERTIES IN THE DEVELOPMENT

### 發展項目中的住宅物業的面積

Description of Residential Property 物業的描述			Saleable Area (including balcony, utility platform and verandah, if any) sq. metre (sq. ft.) 實用面積 (包括露台、工作平台及陽台(如有)) 平方米(平方呎)	Area of other specified items (Not included in the Saleable Area) 其他指明項目的面積(不計算入實用面積) sq. metre (sq. ft.) 平方米(平方呎)										
BlockName 大廈名稱	Floor 樓層	Flat 單位		Air-conditioning plant room 空調機房	Bay window 窗台	Cockloft 閣樓	Flat Roof 平台	Garden 花園	Parking Space 停車位	Roof 天台	Stairhood 梯屋	Terrace 前庭	Yard 庭院	
Tower 2 第2座	G/F 地下	• Garden Apartment	189.846 (2044) Balcony 露台: - Utility Platform 工作平台: - Verandah 陽台: -	-	-	-	-	123.894 (1334)	-	-	-	-	-	
	G/F - 1/F 地下至1樓	Garden Duplex	312.186 (3360) Balcony 露台: 6.000 (65) Utility Platform 工作平台: 1.500 (16) Verandah 陽台: -	-	-	-	6.810 (73)	84.600 (911)	-	-	-	-	-	
	1/F 1樓	B	195.732 (2107) Balcony 露台: 6.000 (65) Utility Platform 工作平台: 1.500 (16) Verandah 陽台: -	-	-	-	10.087 (109)	-	-	-	-	-	-	
	2/F - 3/F & 5/F - 9/F 2樓至3樓及 5樓至9樓	A	195.731 (2107) Balcony 露台: 6.000 (65) Utility Platform 工作平台: 1.500 (16) Verandah 陽台: -	-	-	-	-	-	-	-	-	-	-	-
		B	195.731 (2107) Balcony 露台: 6.000 (65) Utility Platform 工作平台: 1.500 (16) Verandah 陽台: -	-	-	-	-	-	-	-	-	-	-	-
	10/F - 11/F 10樓至11樓	Spa Duplex A	282.960 (3046) Balcony 露台: 6.000 (65) Utility Platform 工作平台: - Verandah 陽台: -	-	-	-	49.643 (534)	-	-	119.778 (1289)	-	-	-	-
		Spa Duplex B	282.960 (3046) Balcony 露台: 6.000 (65) Utility Platform 工作平台: - Verandah 陽台: -	-	-	-	49.643 (534)	-	-	119.778 (1289)	-	-	-	-

The saleable area of each residential property and the floor area of every balcony, utility platform or verandah (if any) to the extent that it forms part of the residential property are calculated in accordance with Section 8 of the Residential Properties (First-hand Sales) Ordinance. The area of other specified items to the extent that it forms part of the residential property (not included in the saleable area) is calculated in accordance with Part 2 of Schedule 2 to the Residential Properties (First-hand Sales) Ordinance.

Notes:

- The areas as specified above in square feet are converted from the area in square metre at a rate of 1 square metre = 10.764 square feet and rounded off to the nearest whole square foot, which may be slightly different from the area presented in square metres.
- There is no verandah in the residential properties of the Development.
- "Terrace Apartment", "Garden Apartment" and "Courtyard Penthouse" are names for marketing purposes only and will not appear in any Deed of Mutual Covenant, the Preliminary Agreement for Sale and Purchase, Agreement for Sale and Purchase, Assignment, or any other title deeds and documents relating to the Development. The names as appearing on the approved building plans are: Flat A on 1/F of Tower 1 for Terrace Apartment on 1/F of Tower 1; Flat B on G/F of Tower 2 for Garden Apartment on G/F of Tower 2; Flat B on G/F of Tower 3 for Garden Apartment on G/F of Tower 3; Flat A on G/F of Tower 7 for Garden Apartment on G/F of Tower 7; Penthouse on 11/F of Tower 7 for Courtyard Penthouse on 11/F of Tower 7; Flat B on G/F of Tower 8 for Garden Apartment on G/F of Tower 8; Penthouse on 11/F of Tower 8 for Courtyard Penthouse on 11/F of Tower 8.

每個住宅物業的實用面積以及構成住宅物業的一部分的範圍內每一露台、工作平台或陽台(如有)的樓面面積,是按照《一手住宅物業銷售條例》第8條計算得出的。構成住宅物業的一部分的其他指明項目的面積(不計算入實用面積)是按照《一手住宅物業銷售條例》附表2第2部計算得出的。

備註:

- 上述以平方呎表述之面積由以平方米表述之面積以1平方米 = 10.764平方呎換算並以四捨五入至整數平方呎之方法計算得出,與以平方米表述之面積可能有些微差異。
- 發展項目住宅物業並無陽台。
- 「Terrace Apartment」、「Garden Apartment」及「Courtyard Penthouse」僅為市場推廣之用的名稱,並不會於關於發展項目的任何公契、臨時買賣合約、買賣合約、轉讓契及契據出現。經批准的建築圖則上顯示的名稱為:第1座1樓A單位(即第1座1樓Terrace Apartment);第2座地下B單位(即第2座地下Garden Apartment);第3座地下B單位(即第3座地下Garden Apartment);第7座地下A單位(即第7座地下Garden Apartment);第7座11樓Penthouse(即第7座11樓Courtyard Penthouse);第8座地下B單位(即第8座地下Garden Apartment);第8座11樓Penthouse(即第8座11樓Courtyard Penthouse)。

## AREA OF RESIDENTIAL PROPERTIES IN THE DEVELOPMENT

### 發展項目中的住宅物業的面積

Description of Residential Property 物業的描述			Saleable Area (including balcony, utility platform and verandah, if any) sq. metre (sq. ft.) 實用面積 (包括露台、工作平台及陽台(如有)) 平方米(平方呎)	Area of other specified items (Not included in the Saleable Area) 其他指明項目的面積(不計算入實用面積)									
BlockName 大廈名稱	Floor 樓層	Flat 單位		Air-conditioning plant room 空調機房	Bay window 窗台	Cockloft 閣樓	Flat Roof 平台	Garden 花園	Parking Space 停車位	Roof 天台	Stairhood 梯屋	Terrace 前庭	Yard 庭院
Tower 3 第3座	G/F 地下	• Garden Apartment	209.534 (2255) Balcony 露台: - Utility Platform 工作平台: - Verandah 陽台: -	-	-	-	-	162.708 (1751)	-	-	-	-	-
	G/F - 1/F 地下至1樓	Garden Duplex	291.284 (3135) Balcony 露台: 6.000 (65) Utility Platform 工作平台: - Verandah 陽台: -	-	-	-	6.092 (66)	89.679 (965)	-	-	-	-	-
	1/F 1樓	B	182.242 (1962) Balcony 露台: - Utility Platform 工作平台: - Verandah 陽台: -	-	-	-	21.414 (231)	-	-	-	-	-	-
	2/F - 3/F & 5/F - 9/F 2樓至3樓及 5樓至9樓	A	187.930 (2023) Balcony 露台: 6.000 (65) Utility Platform 工作平台: 1.500 (16) Verandah 陽台: -	-	-	-	-	-	-	-	-	-	-
	2/F - 3/F & 5/F - 10/F 2樓至3樓及 5樓至10樓	B	189.727 (2042) Balcony 露台: 6.000 (65) Utility Platform 工作平台: 1.500 (16) Verandah 陽台: -	-	-	-	-	-	-	-	-	-	-
	10/F 10樓	A	188.857 (2033) Balcony 露台: 6.000 (65) Utility Platform 工作平台: 1.500 (16) Verandah 陽台: -	-	-	-	-	-	-	-	-	-	-
	11/F 11樓	Sky Pool Penthouse	247.023 (2659) Balcony 露台: 6.000 (65) Utility Platform 工作平台: 1.500 (16) Verandah 陽台: -	-	-	-	102.396 (1102)	-	-	212.180 (2284)	-	-	-

The saleable area of each residential property and the floor area of every balcony, utility platform or verandah (if any) to the extent that it forms part of the residential property are calculated in accordance with Section 8 of the Residential Properties (First-hand Sales) Ordinance. The area of other specified items to the extent that it forms part of the residential property (not included in the saleable area) is calculated in accordance with Part 2 of Schedule 2 to the Residential Properties (First-hand Sales) Ordinance.

Notes:

- The areas as specified above in square feet are converted from the area in square metre at a rate of 1 square metre = 10.764 square feet and rounded off to the nearest whole square foot, which may be slightly different from the area presented in square metres.
- There is no verandah in the residential properties of the Development.
- “Terrace Apartment”, “Garden Apartment” and “Courtyard Penthouse” are names for marketing purposes only and will not appear in any Deed of Mutual Covenant, the Preliminary Agreement for Sale and Purchase, Agreement for Sale and Purchase, Assignment, or any other title deeds and documents relating to the Development. The names as appearing on the approved building plans are: Flat A on 1/F of Tower 1 for Terrace Apartment on 1/F of Tower 1; Flat B on G/F of Tower 2 for Garden Apartment on G/F of Tower 2; Flat B on G/F of Tower 3 for Garden Apartment on G/F of Tower 3; Flat A on G/F of Tower 7 for Garden Apartment on G/F of Tower 7; Penthouse on 11/F of Tower 7 for Courtyard Penthouse on 11/F of Tower 7; Flat B on G/F of Tower 8 for Garden Apartment on G/F of Tower 8; Penthouse on 11/F of Tower 8 for Courtyard Penthouse on 11/F of Tower 8.

每個住宅物業的實用面積以及構成住宅物業的一部分的範圍內每一露台、工作平台或陽台(如有)的樓面面積,是按照《一手住宅物業銷售條例》第8條計算得出的。構成住宅物業的一部分的其他指明項目的面積(不計算入實用面積)是按照《一手住宅物業銷售條例》附表2第2部計算得出的。

備註:

- 上述以平方呎表述之面積由以平方米表述之面積以1平方米 = 10.764平方呎換算並以四捨五入至整數平方呎之方法計算得出,與以平方米表述之面積可能有些微差異。
- 發展項目住宅物業並無陽台。
- 「Terrace Apartment」、「Garden Apartment」及「Courtyard Penthouse」僅為市場推廣之用的名稱,並不會於關於發展項目的任何公契、臨時買賣合約、買賣合約、轉讓契及契據出現。經批准的建築圖則上顯示的名稱為:第1座1樓A單位(即第1座1樓Terrace Apartment);第2座地下B單位(即第2座地下Garden Apartment);第3座地下B單位(即第3座地下Garden Apartment);第7座地下A單位(即第7座地下Garden Apartment);第7座11樓Penthouse(即第7座11樓Courtyard Penthouse);第8座地下B單位(即第8座地下Garden Apartment);第8座11樓Penthouse(即第8座11樓Courtyard Penthouse)。



## AREA OF RESIDENTIAL PROPERTIES IN THE DEVELOPMENT

### 發展項目中的住宅物業的面積

Description of Residential Property 物業的描述			Saleable Area (including balcony, utility platform and verandah, if any) sq. metre (sq. ft.) 實用面積 (包括露台、工作平台及陽台(如有)) 平方米(平方呎)	Area of other specified items (Not included in the Saleable Area) 其他指明項目的面積(不計算入實用面積)									
BlockName 大廈名稱	Floor 樓層	Flat 單位		Air-conditioning plant room 空調機房	Bay window 窗台	Cockloft 閣樓	Flat Roof 平台	Garden 花園	Parking Space 停車位	Roof 天台	Stairhood 梯屋	Terrace 前庭	Yard 庭院
Tower 5 第5座	1/F 1樓	A	150.634 (1621) Balcony 露台: 4.960 (53) Utility Platform 工作平台: 1.500 (16) Verandah 陽台: -	-	-	-	-	-	-	-	-	-	
		B	149.802 (1612) Balcony 露台: 4.960 (53) Utility Platform 工作平台: 1.500 (16) Verandah 陽台: -	-	-	-	-	-	-	-	-	-	
	2/F - 3/F & 5/F - 10/F 2樓至3樓及 5樓至10樓	A	150.785 (1623) Balcony 露台: 4.960 (53) Utility Platform 工作平台: 1.500 (16) Verandah 陽台: -	-	-	-	-	-	-	-	-	-	-
		B	149.802 (1612) Balcony 露台: 4.960 (53) Utility Platform 工作平台: 1.500 (16) Verandah 陽台: -	-	-	-	-	-	-	-	-	-	-
	11/F 11樓	Sky Pool Penthouse	226.273 (2436) Balcony 露台: 4.960 (53) Utility Platform 工作平台: 1.500 (16) Verandah 陽台: -	-	-	-	63.079 (679)	-	-	198.779 (2140)	-	-	-

The saleable area of each residential property and the floor area of every balcony, utility platform or verandah (if any) to the extent that it forms part of the residential property are calculated in accordance with Section 8 of the Residential Properties (First-hand Sales) Ordinance. The area of other specified items to the extent that it forms part of the residential property (not included in the saleable area) is calculated in accordance with Part 2 of Schedule 2 to the Residential Properties (First-hand Sales) Ordinance.

Notes:

- The areas as specified above in square feet are converted from the area in square metre at a rate of 1 square metre = 10.764 square feet and rounded off to the nearest whole square foot, which may be slightly different from the area presented in square metres.
- There is no verandah in the residential properties of the Development.

每個住宅物業的實用面積以及構成住宅物業的一部分的範圍內每一露台、工作平台或陽台(如有)的樓面面積,是按照《一手住宅物業銷售條例》第8條計算得出的。構成住宅物業的一部分的其他指明項目的面積(不計算入實用面積)是按照《一手住宅物業銷售條例》附表2第2部計算得出的。

備註:

- 上述以平方呎表述之面積由以平方米表述之面積以1平方米 = 10.764平方呎換算並以四捨五入至整數平方呎之方法計算得出,與以平方米表述之面積可能有些微差異。
- 發展項目住宅物業並無陽台。



## AREA OF RESIDENTIAL PROPERTIES IN THE DEVELOPMENT

### 發展項目中的住宅物業的面積

Description of Residential Property 物業的描述			Saleable Area (including balcony, utility platform and verandah, if any) sq. metre (sq. ft.) 實用面積 (包括露台、工作平台及陽台(如有)) 平方米(平方呎)	Area of other specified items (Not included in the Saleable Area) 其他指明項目的面積(不計算入實用面積)										
BlockName 大廈名稱	Floor 樓層	Flat 單位		Air-conditioning plant room 空調機房	Bay window 窗台	Cockloft 閣樓	Flat Roof 平台	Garden 花園	Parking Space 停車位	Roof 天台	Stairhood 梯屋	Terrace 前庭	Yard 庭院	
Tower 6 第6座	1/F 1樓	A	149.802 (1612) Balcony 露台: 4.960 (53) Utility Platform 工作平台: 1.500 (16) Verandah 陽台: -	-	-	-	-	-	-	-	-	-	-	
		B	148.983 (1604) Balcony 露台: 3.787 (41) Utility Platform 工作平台: 1.500 (16) Verandah 陽台: -	-	-	-	-	-	-	-	-	-	-	-
	2/F - 3/F & 5/F - 10/F 2樓至3樓及 5樓至10樓	A	149.802 (1612) Balcony 露台: 4.960 (53) Utility Platform 工作平台: 1.500 (16) Verandah 陽台: -	-	-	-	-	-	-	-	-	-	-	-
		B	150.785 (1623) Balcony 露台: 4.960 (53) Utility Platform 工作平台: 1.500 (16) Verandah 陽台: -	-	-	-	-	-	-	-	-	-	-	-
	11/F 11樓	Sky Pool Penthouse	226.273 (2436) Balcony 露台: 4.960 (53) Utility Platform 工作平台: 1.500 (16) Verandah 陽台: -	-	-	-	63.079 (679)	-	-	198.779 (2140)	-	-	-	-

The saleable area of each residential property and the floor area of every balcony, utility platform or verandah (if any) to the extent that it forms part of the residential property are calculated in accordance with Section 8 of the Residential Properties (First-hand Sales) Ordinance. The area of other specified items to the extent that it forms part of the residential property (not included in the saleable area) is calculated in accordance with Part 2 of Schedule 2 to the Residential Properties (First-hand Sales) Ordinance.

#### Notes:

- The areas as specified above in square feet are converted from the area in square metre at a rate of 1 square metre = 10.764 square feet and rounded off to the nearest whole square foot, which may be slightly different from the area presented in square metres.
- There is no verandah in the residential properties of the Development.

每個住宅物業的實用面積以及構成住宅物業的一部分的範圍內每一露台、工作平台或陽台(如有)的樓面面積,是按照《一手住宅物業銷售條例》第8條計算得出的。構成住宅物業的一部分的其他指明項目的面積(不計算入實用面積)是按照《一手住宅物業銷售條例》附表2第2部計算得出的。

#### 備註:

- 上述以平方呎表述之面積由以平方米表述之面積以1平方米 = 10.764平方呎換算並以四捨五入至整數平方呎之方法計算得出,與以平方米表述之面積可能有些微差異。
- 發展項目住宅物業並無陽台。

## AREA OF RESIDENTIAL PROPERTIES IN THE DEVELOPMENT

### 發展項目中的住宅物業的面積

Description of Residential Property 物業的描述			Saleable Area (including balcony, utility platform and verandah, if any) sq. metre (sq. ft.) 實用面積 (包括露台、工作平台及陽台(如有)) 平方米(平方呎)	Area of other specified items (Not included in the Saleable Area) 其他指明項目的面積(不計算入實用面積)									
BlockName 大廈名稱	Floor 樓層	Flat 單位		Air-conditioning plant room 空調機房	Bay window 窗台	Cockloft 閣樓	Flat Roof 平台	Garden 花園	Parking Space 停車位	Roof 天台	Stairhood 梯屋	Terrace 前庭	Yard 庭院
Tower 7 第7座	G/F 地下	• Garden Apartment	146.295 (1575) Balcony 露台: - Utility Platform 工作平台: - Verandah 陽台: -	-	-	-	-	65.442 (704)	-	-	-	-	-
	1/F 1樓	A	150.935 (1625) Balcony 露台: 4.960 (53) Utility Platform 工作平台: 1.500 (16) Verandah 陽台: -	-	-	-	-	-	-	-	-	-	-
		B	150.155 (1616) Balcony 露台: 4.960 (53) Utility Platform 工作平台: 1.500 (16) Verandah 陽台: -	-	-	-	-	-	-	-	-	-	-
	2/F - 3/F & 5/F - 10/F 2樓至3樓及 5樓至10樓	A	150.935 (1625) Balcony 露台: 4.960 (53) Utility Platform 工作平台: 1.500 (16) Verandah 陽台: -	-	-	-	-	-	-	-	-	-	-
		B	150.785 (1623) Balcony 露台: 4.960 (53) Utility Platform 工作平台: 1.500 (16) Verandah 陽台: -	-	-	-	-	-	-	-	-	-	-
	11/F 11樓	• Courtyard Penthouse	225.734 (2430) Balcony 露台: 4.960 (53) Utility Platform 工作平台: 1.500 (16) Verandah 陽台: -	-	-	-	64.256 (692)	-	-	193.027 (2078)	-	-	-

The saleable area of each residential property and the floor area of every balcony, utility platform or verandah (if any) to the extent that it forms part of the residential property are calculated in accordance with Section 8 of the Residential Properties (First-hand Sales) Ordinance. The area of other specified items to the extent that it forms part of the residential property (not included in the saleable area) is calculated in accordance with Part 2 of Schedule 2 to the Residential Properties (First-hand Sales) Ordinance.

#### Notes:

- The areas as specified above in square feet are converted from the area in square metre at a rate of 1 square metre = 10.764 square feet and rounded off to the nearest whole square foot, which may be slightly different from the area presented in square metres.
- There is no verandah in the residential properties of the Development.
- "Terrace Apartment", "Garden Apartment" and "Courtyard Penthouse" are names for marketing purposes only and will not appear in any Deed of Mutual Covenant, the Preliminary Agreement for Sale and Purchase, Agreement for Sale and Purchase, Assignment, or any other title deeds and documents relating to the Development. The names as appearing on the approved building plans are: Flat A on 1/F of Tower 1 for Terrace Apartment on 1/F of Tower 1; Flat B on G/F of Tower 2 for Garden Apartment on G/F of Tower 2; Flat B on G/F of Tower 3 for Garden Apartment on G/F of Tower 3; Flat A on G/F of Tower 7 for Garden Apartment on G/F of Tower 7; Penthouse on 11/F of Tower 7 for Courtyard Penthouse on 11/F of Tower 7; Flat B on G/F of Tower 8 for Garden Apartment on G/F of Tower 8; Penthouse on 11/F of Tower 8 for Courtyard Penthouse on 11/F of Tower 8.

每個住宅物業的實用面積以及構成住宅物業的一部分的範圍內每一露台、工作平台或陽台(如有)的樓面面積,是按照《一手住宅物業銷售條例》第8條計算得出的。構成住宅物業的一部分的其他指明項目的面積(不計算入實用面積)是按照《一手住宅物業銷售條例》附表2第2部計算得出的。

#### 備註:

- 上述以平方呎表述之面積由以平方米表述之面積以1平方米 = 10.764平方呎換算並以四捨五入至整數平方呎之方法計算得出,與以平方米表述之面積可能有些微差異。
- 發展項目住宅物業並無陽台。
- 「Terrace Apartment」、「Garden Apartment」及「Courtyard Penthouse」僅為市場推廣之用的名稱,並不會於關於發展項目的任何公契、臨時買賣合約、買賣合約、轉讓契及契據出現。經批准的建築圖則上顯示的名稱為:第1座1樓A單位(即第1座1樓Terrace Apartment);第2座地下B單位(即第2座地下Garden Apartment);第3座地下B單位(即第3座地下Garden Apartment);第7座地下A單位(即第7座地下Garden Apartment);第7座11樓Penthouse(即第7座11樓Courtyard Penthouse);第8座地下B單位(即第8座地下Garden Apartment);第8座11樓Penthouse(即第8座11樓Courtyard Penthouse)。

## AREA OF RESIDENTIAL PROPERTIES IN THE DEVELOPMENT

### 發展項目中的住宅物業的面積

Description of Residential Property 物業的描述			Saleable Area (including balcony, utility platform and verandah, if any) sq. metre (sq. ft.) 實用面積 (包括露台、工作平台及陽台(如有)) 平方米 (平方呎)	Area of other specified items (Not included in the Saleable Area) 其他指明項目的面積 (不計算入實用面積)								
BlockName 大廈名稱	Floor 樓層	Flat 單位		Air-conditioning plant room 空調機房	Bay window 窗台	Cockloft 閣樓	Flat Roof 平台	Garden 花園	Parking Space 停車位	Roof 天台	Stairhood 梯屋	Terrace 前庭
Tower 8 第8座	G/F 地下	• Garden Apartment	146.315 (1575) Balcony 露台: - Utility Platform 工作平台: - Verandah 陽台: -	-	-	-	72.028 (775)	-	-	-	-	-
	1/F 1樓	A	150.155 (1616) Balcony 露台: 4.960 (53) Utility Platform 工作平台: 1.500 (16) Verandah 陽台: -	-	-	-	-	-	-	-	-	-
		B	150.935 (1625) Balcony 露台: 4.960 (53) Utility Platform 工作平台: 1.500 (16) Verandah 陽台: -	-	-	-	-	-	-	-	-	-
	2/F - 3/F & 5/F - 10/F 2樓至3樓及 5樓至10樓	A	150.785 (1623) Balcony 露台: 4.960 (53) Utility Platform 工作平台: 1.500 (16) Verandah 陽台: -	-	-	-	-	-	-	-	-	-
		B	150.935 (1625) Balcony 露台: 4.960 (53) Utility Platform 工作平台: 1.500 (16) Verandah 陽台: -	-	-	-	-	-	-	-	-	-
	11/F 11樓	• Courtyard Penthouse	225.734 (2430) Balcony 露台: 4.960 (53) Utility Platform 工作平台: 1.500 (16) Verandah 陽台: -	-	-	-	64.256 (692)	-	-	193.027 (2078)	-	-

The saleable area of each residential property and the floor area of every balcony, utility platform or verandah (if any) to the extent that it forms part of the residential property are calculated in accordance with Section 8 of the Residential Properties (First-hand Sales) Ordinance. The area of other specified items to the extent that it forms part of the residential property (not included in the saleable area) is calculated in accordance with Part 2 of Schedule 2 to the Residential Properties (First-hand Sales) Ordinance.

Notes:

- The areas as specified above in square feet are converted from the area in square metre at a rate of 1 square metre = 10.764 square feet and rounded off to the nearest whole square foot, which may be slightly different from the area presented in square metres.
- There is no verandah in the residential properties of the Development.
- “Terrace Apartment”, “Garden Apartment” and “Courtyard Penthouse” are names for marketing purposes only and will not appear in any Deed of Mutual Covenant, the Preliminary Agreement for Sale and Purchase, Agreement for Sale and Purchase, Assignment, or any other title deeds and documents relating to the Development. The names as appearing on the approved building plans are: Flat A on 1/F of Tower 1 for Terrace Apartment on 1/F of Tower 1; Flat B on G/F of Tower 2 for Garden Apartment on G/F of Tower 2; Flat B on G/F of Tower 3 for Garden Apartment on G/F of Tower 3; Flat A on G/F of Tower 7 for Garden Apartment on G/F of Tower 7; Penthouse on 11/F of Tower 7 for Courtyard Penthouse on 11/F of Tower 7; Flat B on G/F of Tower 8 for Garden Apartment on G/F of Tower 8; Penthouse on 11/F of Tower 8 for Courtyard Penthouse on 11/F of Tower 8.

每個住宅物業的實用面積以及構成住宅物業的一部分的範圍內每一露台、工作平台或陽台(如有)的樓面面積,是按照《一手住宅物業銷售條例》第8條計算得出的。構成住宅物業的一部分的其他指明項目的面積(不計算入實用面積)是按照《一手住宅物業銷售條例》附表2第2部計算得出的。

備註:

- 上述以平方呎表述之面積由以平方米表述之面積以1平方米 = 10.764平方呎換算並以四捨五入至整數平方呎之方法計算得出,與以平方米表述之面積可能有些微差異。
- 發展項目住宅物業並無陽台。
- 「Terrace Apartment」、「Garden Apartment」及「Courtyard Penthouse」僅為市場推廣之用的名稱,並不會於關於發展項目的任何公契、臨時買賣合約、買賣合約、轉讓契及契據出現。經批准的建築圖則上顯示的名稱為:第1座1樓A單位(即第1座1樓Terrace Apartment);第2座地下B單位(即第2座地下Garden Apartment);第3座地下B單位(即第3座地下Garden Apartment);第7座地下A單位(即第7座地下Garden Apartment);第7座11樓Penthouse(即第7座11樓Courtyard Penthouse);第8座地下B單位(即第8座地下Garden Apartment);第8座11樓Penthouse(即第8座11樓Courtyard Penthouse)。







# FLOOR PLANS OF PARKING SPACES IN THE DEVELOPMENT

## 發展項目中的停車位的樓面平面圖

### Basement Floor Plan

### 地庫平面圖



Type of Parking Space 停車位類別		Location 位置	Number 數目	Dimensions (L x W) (m.) 尺寸 (長 x 闊) (米)	Area of each parking space (sq. m) 每個停車位面積 (平方米)
	Residential Parking Spaces 住客停車位	B/F 地庫	193	5 x 2.5	12.5
	Residential Accessible Parking Spaces 暢通易達住客停車位		2	5 x 3.5	17.5
	Visitors' Parking Space 訪客停車位		1	5 x 2.5	12.5
	Visitors' Accessible Parking Space 暢通易達訪客停車位		1	5 x 3.5	17.5
	Motor Cycle Parking Spaces 電單車停車位		15	2.5 x 1	2.5

**FLOOR PLANS OF PARKING SPACES IN THE DEVELOPMENT**  
**發展項目中的停車位的樓面平面圖**

**Ground Floor Plan**  
**地下平面圖**



Type of Parking Space 停車位類別	Location 位置	Number 數目	Dimensions (L x W) (m.) 尺寸 (長 x 闊) (米)	Area of each parking space (sq. m) 每個停車位面積 (平方米)
 Loading & Unloading Parking Spaces 上落貨停車位	G/F 地下	7	11 x 3.5	38.5



## SUMMARY OF PRELIMINARY AGREEMENT FOR SALE AND PURCHASE

### 臨時買賣合約的摘要

1. A preliminary deposit of 5% of the purchase price is payable on the signing of the preliminary agreement for sale and purchase;
  2. The preliminary deposit paid by the purchaser on the signing of that preliminary agreement will be held by a firm of solicitors acting for the owner, as stakeholders;
  3. If the purchaser fails to execute the agreement for sale and purchase within 5 working days after the date on which the purchaser enters into that preliminary agreement –
    - i) the preliminary agreement is terminated;
    - ii) the preliminary deposit is forfeited; and
    - iii) the owner does not have any further claim against the purchaser for the failure.
1. 在簽署臨時買賣合約時須支付款額為售價之5%的臨時訂金。
  2. 買方在簽署該臨時買賣合約時支付的臨時訂金，會由代表擁有人行事的律師事務所以保證金保存人的身份持有。
  3. 如買方沒有於訂立該臨時買賣合約的日期之後五個工作日內簽立買賣合約–
    - i) 該臨時買賣合約即告終止；
    - ii) 有關的臨時訂金即予沒收；及
    - iii) 擁有人不得就買方沒有簽立買賣合約而針對買方提出進一步申索。

## SUMMARY OF DEED OF MUTUAL COVENANT

### 公契的摘要

The draft Deed of Mutual Covenant and Management Agreement in respect of the Development (the “DMC”) provides that:

#### 1. The common parts of the Development

“Common Areas and Facilities” means collectively the Development Common Areas and Facilities, the Residential Common Areas and Facilities, the Tower Common Areas and Facilities, the House Common Areas and Facilities, the Carpark Common Areas and Facilities and such other areas and facilities of and in the Land and the Development as may from time to time be designated as additional common areas and facilities in accordance with the DMC or any Sub-Deed (as defined in the DMC).

“Development Common Areas and Facilities” means:-

- (a) the Covered Landscaped and Play Areas, the Greenery Areas, the Owners’ Corporation Office, the Pink Hatched Brown Area, the Public Access, the Replacement Access, the Slope Structures, the Watchmen and Caretakers’ Room (all as defined in the DMC);
- (b) the foundations, columns, beams and other structural supports and elements, back fill area, cleansing water pump rooms, cleansing water tanks, driveways, electricity rooms, emergency generator rooms, emergency vehicular access, extra low voltage rooms, fire service sprinkler pump rooms, fire service street fire hydrant pump rooms, fire service pump rooms, fire service tanks, fire service water meter room, fuel tank rooms, irrigation pump rooms, irrigation water tanks, low voltage switch rooms, master water meter room, main low voltage switch room, parking space for refuse collection, refuse collection chamber, services corridor, sprinkler water tanks, storm water pump rooms, storm water tanks, street hydrant water tanks, switch rooms, telecommunications and broadcasting equipment room, temporary storm water storage rooms, transformer room, fire service control & sprinkler control valve room, refuse collection room;
- (c) wires, cables, ducts, pipes, drains, and all mechanical and electrical installations and equipment exclusively for the Development as a whole (and not just any particular Unit); and
- (d) such areas and facilities provided in the Land (as defined in the DMC) and the Development intended for the common use and benefit of the Development as a whole

which for the purposes of identification only are shown coloured Green, Green Hatched Black and Grey on the floor plans annexed to the DMC, shown coloured Indigo on the Ground Floor plans annexed to the DMC and shown coloured Green and by Red lines on the Greenery Areas plans annexed to the DMC, and shall include such other areas and facilities of and in the Land and the Development as may from time to time be designated as additional Development Common Areas in accordance with the DMC or any Sub-Deed PROVIDED THAT where appropriate, if any parts of the Development (other than the Residential Accommodation (as defined in the DMC) and the Carpark (as defined in the DMC)):-

- (i) are covered by paragraph (a) of the definition of “common parts” set out in section 2 of the Building Management Ordinance and/or
- (ii) fall within the categories as specified in Schedule 1 to the Building Management Ordinance and included under paragraph (b) of the definition of “common parts” set out in section 2 of the Building Management Ordinance,

then such parts shall be deemed to have been included as, and shall form part of, the Development Common Areas and Facilities,

but shall exclude the Residential Common Areas and Facilities, the Tower Common Areas and Facilities, the House Common Areas and Facilities and the Carpark Common Areas and Facilities.

“Residential Common Areas and Facilities” means:-

- (a) the Club House, the Residential Loading and Unloading Spaces, the Visitor Parking Spaces, lift lobbies, lift shafts, staircases, electrical rooms, extra low voltage rooms, filtration plant room, fresh water tank, fresh water pump room, flush water tank, flush water pump room, services corridor (all as defined in the DMC);
- (b) wires, cables, ducts, pipes, drains, and all mechanical and electrical installations and equipment exclusively for the Residential Accommodation as a whole (and not just any particular Residential Unit); and
- (c) such areas and facilities provided in the Land and the Development intended for the common use and benefit of the Residential Accommodation as a whole

which for the purposes of identification only are shown coloured Pink on the plans annexed to the DMC, and shall include

such other areas and facilities of and in the Land and the Development as may from time to time be designated as additional Residential Common Areas and Facilities in accordance with the provisions of the DMC or any Sub-Deed PROVIDED THAT where appropriate, if any parts of the Residential Accommodation:-

- (i) are covered by paragraph (a) of the definition of “common parts” set out in section 2 of the Building Management Ordinance and/or
- (ii) fall within the categories as specified in Schedule 1 to the Building Management Ordinance and included under paragraph (b) of the definition of “common parts” set out in section 2 of the Building Management Ordinance,

then such parts shall be deemed to have been included as, and shall form part of, the Residential Common Areas and Facilities

but shall exclude the Development Common Areas and Facilities, the Tower Common Areas and Facilities, the House Common Areas and Facilities and the Carpark Common Areas and Facilities.

“Tower Common Areas and Facilities” means:-

- (a) the Curtain Wall of the Residential Towers (as defined in the DMC), lift lobbies, lift platforms, lift machine rooms, lift shafts, canopies, common staircases, water meter cabinets, electrical meter rooms, electrical low voltage room, entrance lobbies, external wall (including non-structural prefabricated external walls shown coloured Indigo on the plans annexed to the DMC (in so far as it forms part of the Tower Common Areas and Facilities)) of the Residential Towers, fire service pump room, fire service water tank, fresh water tank, fresh water pump room, flush water tank, flush water pump room, gondola, low voltage switch room, refuse storage and material recovery rooms, pipe ducts, telecommunications cable ducts, electrical low voltage cable ducts, sprinkler inlets, fire services inlets, top roofs, variable refrigerant volume rooms;
- (b) wires, cables, ducts, pipes, drains, and all mechanical and electrical installations and equipment exclusively for the Residential Towers as a whole (and not just any particular Flat); and
- (c) such areas and facilities of and in the Land and the Development intended for the common use and benefit of the Residential Towers as a whole

which for the purposes of identification only are shown coloured Orange on the plans annexed to the DMC, and shall include such other areas and facilities of and in the Land and the Development as are now or may from time to time be designated as additional Tower Common Areas and Facilities in accordance with the DMC or any Sub-Deed PROVIDED THAT where appropriate, if any parts of the Residential Towers:-

- (i) are covered by paragraph (a) of the definition of “common parts” set out in section 2 of the Building Management Ordinance; and/or
- (ii) fall within the categories as specified in Schedule 1 to the Building Management Ordinance and included under paragraph (b) of the definition of “common parts” set out in section 2 of the Building Management Ordinance,

then such parts shall be deemed to have been included as, and shall form part of, the Tower Common Areas and Facilities,

but shall exclude the Development Common Areas and Facilities, the Residential Common Areas and Facilities, the House Common Areas and Facilities and the Carpark Common Areas and Facilities.

“House Common Areas and Facilities” means:-

- (a) fresh water tanks, fresh and cleansing water pump room, flush water tanks, fresh and flush water pump rooms;
- (b) wires, cables, ducts, pipes, drains, and all mechanical and electrical installations and equipment exclusively for the Houses as a whole (and not just any particular House); and
- (c) such areas and facilities provided in the Land and the Development intended for the common use and benefit of the Houses as a whole

which for the purposes of identification only are shown coloured Violet on the plans annexed to the DMC, and shall include such other areas and facilities of and in the Land and the Development as may from time to time be designated as additional House Common Areas and Facilities in accordance with the provisions of the DMC or any Sub-Deed PROVIDED THAT where appropriate, if any parts of the Houses:-

## SUMMARY OF DEED OF MUTUAL COVENANT

### 公契的摘要

- (i) are covered by paragraph (a) of the definition of “common parts” set out in section 2 of the Building Management Ordinance and/or
- (ii) fall within the categories as specified in Schedule 1 to the Building Management Ordinance and included under paragraph (b) of the definition of “common parts” set out in section 2 of the Building Management Ordinance,

then such parts shall be deemed to have been included as, and shall form part of, the House Common Areas and Facilities

but shall exclude the Development Common Areas and Facilities, Residential Common Areas and Facilities, the Tower Common Areas and Facilities and the Carpark Common Areas and Facilities.

“Carpark Common Areas and Facilities” means:-

- (a) the whole of the Carpark (except the Residential Parking Spaces, the Motor Cycle Parking Spaces and the Visitor Parking Spaces) (all as defined in the DMC);
- (b) driveways, electrical meter rooms, extra low voltage rooms, exhaust fan rooms, smoke vents, staircases;
- (c) wires, cables, ducts, pipes, drains, and all mechanical and electrical installations and equipment exclusively for the Carpark as a whole (and not just any particular Parking Space); and
- (d) such areas and facilities provided in the Land and the Development intended for the common use and benefit of the Carpark as a whole

which for the purposes of identification only are shown coloured Yellow on the plans annexed to the DMC, and shall include such other areas and facilities of and in the Land and the Development as may from time to time be designated as additional Carpark Common Areas and Facilities in accordance with the DMC or any Sub-Deed PROVIDED THAT where appropriate, if any parts of the Carpark:-

- (i) are covered by paragraph (a) of the definition of “common parts” set out in section 2 of the Building Management Ordinance; and/or
- (ii) fall within the categories as specified in Schedule 1 to the Building Management Ordinance and included under paragraph (b) of the definition of “common parts” set out in section 2 of the Building Management Ordinance,

then such parts shall be deemed to have been included as, and shall form part of, the Carpark Common Areas and Facilities,

but shall exclude the Development Common Areas and Facilities, the Residential Common Areas and Facilities, the Tower Common Areas and Facilities and the House Common Areas and Facilities.

#### 2. The number of undivided shares assigned to each residential property in the Development

Please refer to the “Table of Allocation of Undivided Shares” in this section below for the number of undivided shares assigned to each residential property.

#### 3. The term of years for which the manager of the Development is appointed

Regal Estate Management Limited will be appointed the manager of the Development initially for a term of not exceeding 2 years commencing from the date of the DMC and to be continued thereafter unless and until terminated in accordance with the DMC.

#### 4. The basis on which the management expenses are shared among the owners of the residential properties in the Development

Each Owner of a Residential Unit shall contribute towards the management expenses (which shall be based on the budget prepared by the Manager) of the Development in such manner, amount and proportion as provided in the DMC by reference to the Management Shares allocated to his Residential Unit and the principles provided in the DMC.

#### 5. The basis on which the management fee deposit is fixed

The amount of management fee deposit shall be a sum equal to 2/12th of the first year’s budgeted Management Expenses payable in respect of a Unit.

#### 6. The area in the Development retained by the owner for that owner’s own use:

Not applicable.

Note:

For full details, please refer to the draft DMC which is free for inspection during opening hours at the sales office. Full script of the draft DMC is available for inspection upon request and copies of the draft DMC can be obtained upon paying necessary photocopying charges.

## SUMMARY OF DEED OF MUTUAL COVENANT

### 公契的摘要

有關發展項目公契及管理協議(「公契」)擬稿有下述條文：

#### 1. 發展項目的公用部分

「公用地方及設施」統指發展項目公用地方及設施、住宅公用地方及設施、大廈公用地方及設施、洋房公用地方及設施、停車場公用地方及設施和不時按公契或任何公契分契(定義見公契)指定作為附加公用地方及設施的該土地及發展項目的其他區域及設施。

「發展項目公用地方及設施」指：

- (a) 有蓋園藝及遊樂區、綠化區、業主立案法團辦事處、粉紅色加棕斜線範圍、公共通道、替代通道、斜坡構築物、看更及管理員室(所有定義見公契)；
- (b) 地基、支柱、橫樑及其他結構承托物及物件、回填區、清潔水泵房、清潔水水箱、車道、電力房、緊急發電機房、緊急車輛通道、超低電壓房、消防灑水器泵房、街道消防栓泵房、消防泵房、消防水箱、消防水錶房、燃料箱房、灌溉泵房、灌溉水箱、低壓電掣房、總水錶房、主低壓電掣房、垃圾收集車停車位、垃圾收集房、服務走廊、灑水器水箱、暴雨水泵房、暴雨水箱、街道消防栓水箱、電掣房、電訊及廣播設備房、臨時暴雨儲存室、變壓器房、消防控制及灑水器控制閥室、垃圾收集房；
- (c) 專門服務整個發展項目(而並非僅為任何個別單位)的電線、電纜、槽、管道、排水渠和一切機電裝置及設備；
- (d) 在該土地及發展項目內擬提供給整個發展項目共同使用與享用的該等區域及設施，

在公契附錄的樓層圖則上用綠色、綠色加黑斜線和灰色顯示，在公契附錄的地面圖則上用靛青色顯示，在公契附錄的綠化區圖則上用綠色加紅線顯示，僅供識別，並包括在任何時候按公契或任何公契分契指定作為附加發展項目公用地方的該土地(定義見公契)及發展項目的其他區域及設施，但是如適用，如果發展項目的任何部分(住宇樓宇(定義見公契)和停車場(定義見公契)除外)：

- (i) 被建築物管理條例第2條列明的「公用部分」的定義第(a)段所涵蓋，及/或
- (ii) 屬於建築物管理條例第一附表指定的類別並被納入建築物管理條例第2條列明的「公用部分」的定義第(b)段所涵蓋，

則該等部分應視為被納入並構成發展項目公用地方及設施，

但是不包括住宅公用地方及設施、大廈公用地方及設施、洋房公用地方及設施和停車場公用地方及設施。

「住宅公用地方及設施」指：

- (a) 會所、住宅裝卸區、訪客停車位、升降機大堂、升降機槽、樓梯、電力房、超低電壓房、過濾機房、食水水箱、食水泵房、沖廁水水箱、沖廁水泵房、服務通道(所有定義見公契)；
- (b) 專門服務整個住宇樓宇(而並非僅為任何個別單位)的電線、電纜、槽、管道、排水渠和一切機電裝置及設備；
- (c) 在該土地及發展項目內提供給整個住宇樓宇共同使用與享用的該等區域及設施，

在公契附錄的圖則上用粉紅色顯示，僅供識別，並包括在任何時候按公契或任何公契分契指定作為附加住宅公用地方及設施的該土地及發展項目的其他區域及設施，但是如適用，如果住宇樓宇的任何部分：

- (i) 被建築物管理條例第2條列明的「公用部分」的定義第(a)段所涵蓋，及/或
- (ii) 屬於建築物管理條例第一附表指定的類別並被納入建築物管理條例第2條列明的「公用部分」的定義第(b)段所涵蓋，

則該等部分應視為被納入並構成住宅公用地方及設施，

但是不包括發展項目公用地方及設施、大廈公用地方及設施、洋房公用地方及設施和停車場公用地方及設施。

「大廈公用地方及設施」指：

- (a) 住宅大廈的幕牆(定義見公契)、升降機大堂、升降機平台、升降機機房、升降機槽、簷篷、公共樓梯、水錶櫃、電錶房、低壓電房、入口大堂、住宅大廈的外牆(包括在公契附錄的圖則上用靛青色顯示的非結構預製外牆(如果屬於大廈公用地方及設施之部分))、消防泵房、消防水箱、食水水箱、食水泵房、沖廁水水箱、沖廁水泵房、吊船、低壓電掣房、垃圾儲存及物料回收室、管槽、電訊電纜槽、電力低壓電纜槽、灑水器進水口、消防進水口、屋頂、變頻空調室；
- (b) 專門服務整個住宅大廈(而並非僅為任何個別居住單位)的電線、電纜、槽、管道、排水渠和一切機電裝置及設備；
- (c) 在該土地及發展項目內提供給整個住宅大廈共同使用與享用的該等區域及設施，

在公契附錄的圖則上用橙色顯示，僅供識別，並包括在任何時候按公契或任何公契分契指定作為附加大廈公用地方及設施的該土地及發展項目的其他區域及設施，但是如適用，如果住宅大廈的任何部分：

- (i) 被建築物管理條例第2條列明的「公用部分」的定義第(a)段所涵蓋，及/或
- (ii) 屬於建築物管理條例第一附表指定的類別並被納入建築物管理條例第2條列明的「公用部分」的定義第(b)段所涵蓋，

則該等部分應視為被納入並構成大廈公用地方及設施，

但是不包括發展項目公用地方及設施、住宅公用地方及設施、洋房公用地方及設施和停車場公用地方及設施。

「洋房公用地方及設施」指：

- (a) 食水水箱、食水及清潔水泵房、沖廁水水箱、食水及沖廁水泵房；
- (b) 專門服務所有洋房(而並非僅為任何個別洋房)的電線、電纜、槽、管道、排水渠和一切機電裝置及設備；
- (c) 在該土地及發展項目內擬提供給所有洋房共同使用與享用的該等區域及設施，

在公契附錄的圖則上用紫色顯示，僅供識別，並包括在任何時候按公契或任何公契分契指定作為附加洋房公用地方及設施的該土地及發展項目的其他區域及設施，但是如適用，如果洋房的任何部分：

- (i) 被建築物管理條例第2條列明的「公用部分」的定義第(a)段所涵蓋，及/或
- (ii) 屬於建築物管理條例第一附表指定的類別並被納入建築物管理條例第2條列明的「公用部分」的定義第(b)段所涵蓋，

則該等部分應視為被納入並構成洋房公用地方及設施，

但是不包括發展項目公用地方及設施、住宅公用地方及設施、大廈公用地方及設施和停車場公用地方及設施。



## SUMMARY OF DEED OF MUTUAL COVENANT

### 公契的摘要

「停車場公用地方及設施」指：

- (a) 整個停車場(住宅停車位、電單車停車位及訪客停車位除外)；
- (b) 車道、電錶房、超低電壓房、排氣扇房、煙槽、樓梯；
- (c) 專門服務整個停車場(而並非僅為任何個別停車位)的電線、電纜、槽、管道、排水渠及一切機械及電力裝置及設備；
- (d) 在該土地及發展項目內提供給整個停車場共同使用與享用的該等區域及設施，

在公契附錄的圖則上用黃色顯示，僅供識別，並包括在任何時候按公契或任何公契分契指定作為附加停車場公用地方及設施的該土地及發展項目的其他區域及設施，但是如適用，如果停車場的任何部分：

- (i) 被建築物管理條例第2條列明的「公用部分」的定義第(a)段所涵蓋，及/或
- (ii) 屬於建築物管理條例第一附表指定的類別並被納入建築物管理條例第2條列明的「公用部分」的定義第(b)段所涵蓋，

則該等部分應視為被納入並構成停車場公用地方及設施，

但是不包括發展項目公用地方及設施、住宅公用地方及設施、大廈公用地方及設施和洋房公用地方及設施。

#### 2. 分配予發展項目中的每個住宅物業的不分割份數的數目

有關分配予每個住宅物業的不分割份數的數目請參閱本節下文「不分割份數的分配表」。

#### 3. 有關發展項目的管理人的委任年期

富豪物業管理有限公司獲委任為發展項目的管理人，首次任期由公契的日期起計不超過兩年，並於期滿後獲繼續任職直至根據公契條款終止為止。

#### 4. 管理開支在發展項目中的住宅物業的擁有人之間分擔的基準

每名住宅物業的擁有人應根據分配予其住宅物業的管理份數，按照公契訂明的準則，以公契規定的方式、金額和比例分擔發展項目的管理開支(根據管理人所編製的預算案所計算)。

#### 5. 計算管理費按金的基準

管理費按金相當於單位應付第一年預算管理開支之十二份之二。

#### 6. 擁有人在發展項目中保留作自用的範圍：

不適用

備註：

請查閱公契擬稿以了解全部詳情。完整的公契擬稿現存於售樓處，於開放時間可供免費查閱，並可在支付所需影印費後取得公契擬稿之複印本。



# SUMMARY OF DEED OF MUTUAL COVENANT

## 公契的摘要

Table of Allocation of Undivided Shares

不分割份數的分配表

A. Flats

A. 單位

Tower 座	Floor 樓層	Unit 單位	Undivided Shares 不分割份數
1	G/F – 1/F 地下至1樓	Garden Duplex	6,065
	1/F 1樓	Flat A 單位A	3,930
	2/F 2樓	Flat A 單位A	3,795
		Flat B 單位B	3,759
	3/F 3樓	Flat A 單位A	3,795
		Flat B 單位B	3,759
	5/F 5樓	Flat A 單位A	3,795
		Flat B 單位B	3,759
	6/F 6樓	Flat A 單位A	3,795
		Flat B 單位B	3,759
	7/F 7樓	Flat A 單位A	3,795
		Flat B 單位B	3,759
	8/F 8樓	Flat A 單位A	3,795
		Flat B 單位B	3,759
	9/F 9樓	Flat A 單位A	3,795
		Flat B 單位B	3,759
10/F 10樓	Flat A 單位A	3,795	
	Flat B 單位B	3,777	
11/F 11樓	Sky Pool Penthouse	5,569	

Tower 座	Floor 樓層	Unit 單位	Undivided Shares 不分割份數
2	G/F 地下	Flat B 單位B	4,045
	G/F – 1/F 地下至1樓	Garden Duplex	6,427
	1/F 1樓	Flat B 單位B	3,935
	2/F 2樓	Flat A 單位A	3,915
		Flat B 單位B	3,915
	3/F 3樓	Flat A 單位A	3,915
		Flat B 單位B	3,915
	5/F 5樓	Flat A 單位A	3,915
		Flat B 單位B	3,915
	6/F 6樓	Flat A 單位A	3,915
		Flat B 單位B	3,915
	7/F 7樓	Flat A 單位A	3,915
		Flat B 單位B	3,915
	8/F 8樓	Flat A 單位A	3,915
		Flat B 單位B	3,915
	9/F 9樓	Flat A 單位A	3,915
		Flat B 單位B	3,915
	10/F - 11/F 10樓至11樓	Spa Duplex A	5,998
		Spa Duplex B	5,998

SUMMARY OF DEED OF MUTUAL COVENANT

公契的摘要

Tower 座	Floor 樓層	Unit 單位	Undivided Shares 不分割份數
3	G/F 地下	Flat B 單位B	4,516
	G/F – 1/F 地下至1樓	Garden Duplex	6,018
	1/F 1樓	Flat B 單位B	3,688
	2/F 2樓	Flat A 單位A	3,759
		Flat B 單位B	3,795
	3/F 3樓	Flat A 單位A	3,759
		Flat B 單位B	3,795
	5/F 5樓	Flat A 單位A	3,759
		Flat B 單位B	3,795
	6/F 6樓	Flat A 單位A	3,759
		Flat B 單位B	3,795
	7/F 7樓	Flat A 單位A	3,759
		Flat B 單位B	3,795
	8/F 8樓	Flat A 單位A	3,759
		Flat B 單位B	3,795
	9/F 9樓	Flat A 單位A	3,759
		Flat B 單位B	3,795
10/F 10樓	Flat A 單位A	3,777	
	Flat B 單位B	3,795	
11/F 11樓	Sky Pool Penthouse	5,569	

Tower 座	Floor 樓層	Unit 單位	Undivided Shares 不分割份數
5	1/F 1樓	Flat A 單位A	3,013
		Flat B 單位B	2,996
	2/F 2樓	Flat A 單位A	3,016
		Flat B 單位B	2,996
	3/F 3樓	Flat A 單位A	3,016
		Flat B 單位B	2,996
	5/F 5樓	Flat A 單位A	3,016
		Flat B 單位B	2,996
	6/F 6樓	Flat A 單位A	3,016
		Flat B 單位B	2,996
	7/F 7樓	Flat A 單位A	3,016
		Flat B 單位B	2,996
	8/F 8樓	Flat A 單位A	3,016
		Flat B 單位B	2,996
	9/F 9樓	Flat A 單位A	3,016
		Flat B 單位B	2,996
	10/F 10樓	Flat A 單位A	3,016
		Flat B 單位B	2,996
	11/F 11樓	Sky Pool Penthouse	5,049

SUMMARY OF DEED OF MUTUAL COVENANT

公契的摘要

Tower 座	Floor 樓層	Unit 單位	Undivided Shares 不分割份數
6	1/F 1樓	Flat A 單位A	2,996
		Flat B 單位B	2,980
	2/F 2樓	Flat A 單位A	2,996
		Flat B 單位B	3,016
	3/F 3樓	Flat A 單位A	2,996
		Flat B 單位B	3,016
	5/F 5樓	Flat A 單位A	2,996
		Flat B 單位B	3,016
	6/F 6樓	Flat A 單位A	2,996
		Flat B 單位B	3,016
	7/F 7樓	Flat A 單位A	2,996
		Flat B 單位B	3,016
	8/F 8樓	Flat A 單位A	2,996
		Flat B 單位B	3,016
	9/F 9樓	Flat A 單位A	2,996
		Flat B 單位B	3,016
	10/F 10樓	Flat A 單位A	2,996
		Flat B 單位B	3,016
11/F 11樓	Sky Pool Penthouse	5,049	

Tower 座	Floor 樓層	Unit 單位	Undivided Shares 不分割份數
7	G/F 地下	Flat A 單位A	3,057
	1/F 1樓	Flat A 單位A	3,019
		Flat B 單位B	3,003
	2/F 2樓	Flat A 單位A	3,019
		Flat B 單位B	3,016
	3/F 3樓	Flat A 單位A	3,019
		Flat B 單位B	3,016
	5/F 5樓	Flat A 單位A	3,019
		Flat B 單位B	3,016
	6/F 6樓	Flat A 單位A	3,019
		Flat B 單位B	3,016
	7/F 7樓	Flat A 單位A	3,019
		Flat B 單位B	3,016
	8/F 8樓	Flat A 單位A	3,019
		Flat B 單位B	3,016
	9/F 9樓	Flat A 單位A	3,019
		Flat B 單位B	3,016
	10/F 10樓	Flat A 單位A	3,019
		Flat B 單位B	3,016
	11/F 11樓	Penthouse	5,030

**SUMMARY OF DEED OF MUTUAL COVENANT**

**公契的摘要**

Tower 座	Floor 樓層	Unit 單位	Undivided Shares 不分割份數
8	G/F 地下	Flat B 單位B	3,070
	1/F 1樓	Flat A 單位A	3,003
		Flat B 單位B	3,019
	2/F 2樓	Flat A 單位A	3,016
		Flat B 單位B	3,019
	3/F 3樓	Flat A 單位A	3,016
		Flat B 單位B	3,019
	5/F 5樓	Flat A 單位A	3,016
		Flat B 單位B	3,019
	6/F 6樓	Flat A 單位A	3,016
		Flat B 單位B	3,019
	7/F 7樓	Flat A 單位A	3,016
		Flat B 單位B	3,019
	8/F 8樓	Flat A 單位A	3,016
		Flat B 單位B	3,019
	9/F 9樓	Flat A 單位A	3,016
		Flat B 單位B	3,019
	10/F 10樓	Flat A 單位A	3,016
		Flat B 單位B	3,019
11/F 11樓	Penthouse	5,030	

Remarks:

1. There is no designation of Tower 4.
2. There is no designation of 4/F.
3. There is no designation of House 4, 13, 14 and 24.

**B. Houses**

**B. 洋房**

House 洋房	Undivided Shares 不分割份數
1	5,509
2	5,411
3	5,415
5	5,405
6	5,408
7	5,417
8	4,396
9	4,347
10	4,376
11	6,300
12	7,267
15	5,923
16	5,955
17	5,990
18	6,027
19	6,033
20	6,094
21	6,130
22	6,161
23	10,516
25	5,055
26	5,055
27	5,055
28	5,077

備註：

1. 不設第4座。
2. 不設4樓。
3. 不設4、13、14及24號洋房。

## SUMMARY OF LAND GRANT

### 批地文件的摘要

1. The Development is constructed on Sha Tin Town Lot No. 578 (the "Lot") which is held under New Grant No. 21670 dated 17 October 2013, as varied or modified by an Approval Letter dated 5 January 2016 and registered in the Land Registry by Memorial No.16011402340012 (collectively the "Land Grant").
2. The Lot is granted for a term of 50 years commencing from 17 October 2013.
3. General Condition No. 7 of the Land Grant stipulates that:-
  - “(a) The Purchaser shall throughout the tenancy having built or rebuilt (which word refers to redevelopment as contemplated in sub-clause (b) of this General Condition) in accordance with these Conditions:
    - (i) maintain all buildings in accordance with the approved design and disposition and any approved building plans without variation or modification thereto; and
    - (ii) maintain all buildings erected or which may hereafter be erected in accordance with these Conditions or any subsequent contractual variation of them, in good and substantial repair and condition and in such repair and condition deliver up the same at the expiration or sooner determination of the tenancy.
  - (b) In the event of the demolition at any time during the tenancy of any building then standing on the Lot or any part thereof, the Purchaser shall replace the same either by sound and substantial building or buildings of the same type and of no less gross floor area or by building or buildings of such type and value as shall be approved by the Director of Lands (the "Director"). In the event of demolition as aforesaid, the Purchaser shall within one calendar month of such demolition apply to the Director for consent to carry out building works for the redevelopment of the Lot and upon receiving such consent shall within three calendar months thereof commence the necessary works of redevelopment and shall complete the same to the satisfaction of and within such time limit as is laid down by the Director.”
4. Special Condition No. (3) of the Land Grant stipulates that:-

“The Purchaser shall develop the Lot by the erection thereon of a building or buildings complying in all respects with these Conditions and all Ordinances, bye-laws and regulations relating to building, sanitation and planning which are or may at any time be in force in Hong Kong, such building or buildings to be completed and made fit for occupation on or before the 30th day of June, 2019.”
5. Special Condition No. (4) of the Land Grant stipulates that:

“The Lot or any part thereof or any building or part of any building erected or to be erected thereon shall not be used for any purpose other than for private residential purposes.”
6. Special Condition No. (9) of the Land Grant stipulates that:-
  - “(a) The Purchaser may erect, construct and provide within the Lot such recreational facilities and facilities ancillary thereto (hereinafter referred to as “the Facilities”) as may be approved in writing by the Director. The type, size, design, height and disposition of the Facilities shall also be subject to the prior written approval of the Director.
  - (b) For the purpose of calculating the total gross floor area stipulated in Special Condition No. (5)(c) hereof, subject to Special Condition No. (39)(d) hereof, any part of the Facilities provided within the Lot in accordance with sub-clause (a) of this Special Condition which are for the common use and benefit of the residents of the residential block or blocks erected or to be erected on the Lot and their bona fide visitors shall not be taken into account. The remaining part of the Facilities which, in the opinion of the Director, are not for such use shall be taken into account for such calculation.
  - (c) In the event that any part of the Facilities is exempted from the gross floor area calculation pursuant to sub-clause (b) of this Special Condition (hereinafter referred to as “the Exempted Facilities”):
    - (i) the Exempted Facilities shall be designated as and form part of the Common Areas referred to in Special Condition No. 17(a)(v) hereof;
    - (ii) the Purchaser shall at his own expense maintain the Exempted Facilities in good and substantial repair and condition and shall operate the Exempted Facilities to the satisfaction of the Director; and
    - (iii) the Exempted Facilities shall only be used by the residents of the residential block or blocks erected or to be erected on the Lot and their bona fide visitors and by no other person or persons.
- (d) In the event that the Lot is developed for use as single family residence, sub-clauses (b) and (c) of this Special Condition shall not apply. The decision of the Director as to whether the Lot is developed for use as a single family residence shall be final and binding on the Purchaser.”
7. Special Condition No. (10) of the Land Grant stipulates that:-

“No tree growing on the Lot or adjacent thereto shall be removed or interfered with without the prior written consent of the Director who may, in granting consent, impose such conditions as to transplanting, compensatory landscaping or replanting as he may deem appropriate.”
8. Special Condition No. (11) of the Land Grant stipulates that:-
  - “(a) The Purchaser shall at his own expense submit to the Director for his approval a landscape master plan indicating the location, disposition and layout of the landscaping works to be provided within the Lot in compliance with the requirements stipulated in sub-clause (b) of this Special Condition. No site formation works shall be commenced on the Lot or any part thereof until the landscape master plan has been approved in writing by the Director and consent, if required, has been granted in respect of the proposals for the preservation of trees under Special Condition No. (10) hereof.
  - (b)
    - (i) The landscape master plan shall be at a scale of 1:500 or larger and shall contain information on the landscaping proposals including a survey and treatment of existing trees, site layout and formation levels, conceptual form of building development, illustrative layout of hard and soft landscaping areas and such other information as the Director may require.
    - (ii) Not less than 20% of the area of the Lot shall be planted with trees, shrubs or other plants.
    - (iii) Not less than 50% of the 20% referred to in sub-clause (b)(ii) of this Special Condition (hereinafter referred to as “the Greenery Area”) shall be provided at such location or level as may be determined by the Director at his sole discretion so that the Greenery Area shall be visible to pedestrians or accessible by any person or persons entering the Lot.
    - (iv) The decision of the Director on which landscaping works proposed by the Purchaser constitute the 20% referred to in sub-clause (b)(ii) of this Special Condition shall be final and binding on the Purchaser.
    - (v) The Director at his sole discretion may accept other non-planting features proposed by the Purchaser as an alternative to planting trees, shrubs or other plants.
  - (c) The Purchaser shall at his own expense landscape the Lot in accordance with the approved landscape master plan in all respects to the satisfaction of the Director and no amendment, variation, alteration, modification or substitution of the approved landscape master plan shall be made without the prior written consent of the Director.
  - (d) The Purchaser shall thereafter at his own expense keep and maintain the landscaped works in a safe, clean, neat, tidy and healthy condition all to the satisfaction of the Director.
  - (e) The area or areas landscaped in accordance with this Special Condition shall be designated as and form part of the Common Areas referred to in Special Condition No. (17)(a)(v) hereof.
  - (f) In the event that the Lot is developed for use as a single family residence, sub-clauses (b)(iii) and (e) of this Special Condition shall not apply. The decision of the Director as to whether the Lot is developed for use as a single family residence shall be final and binding on the Purchaser.”
9. Special Condition No. (20) of the Land Grant stipulates that:-
  - “(a)
    - (i) Spaces shall be provided within the Lot to the satisfaction of the Director for the parking of motor vehicles licensed under the Road Traffic Ordinance, any regulations made thereunder and any amending legislation, and belonging to the residents of the building or buildings erected or to be erected on the Lot and their bona fide guests, visitors or invitees (hereinafter referred to as “the Residential Parking Spaces”) at the following rates:
      - (I) where a block or blocks of residential units (other than a detached, semi-detached or terraced house or houses which is or are intended for use as single family residence or residences) are provided within the Lot, at a rate to be calculated by reference to the respective size of the residential units erected or to be erected on the Lot as set out in the table below unless the Director consents to a rate or to a number different from those set out in the table below:



## SUMMARY OF LAND GRANT

### 批地文件的摘要

Size of each residential unit	No. of the Residential Parking Spaces to be provided
Less than 40 square metres	One space for every 13.3 residential units or part thereof
Not less than 40 square metres but less than 70 square metres	One space for every 8 residential units or part thereof
Not less than 70 square metres but less than 100 square metres	One space for every 3.2 residential units or part thereof
Not less than 100 square metres but less than 160 square metres	One space for every 1.6 residential units or part thereof
Not less than 160 square metres	One space for one residential unit

(II) where a detached, semi-detached or terraced house or houses which is or are intended for use as single family residence or residences are provided within the Lot, at the rates of:

(A) one space for each such house where its gross floor area is less than 160 square metres and 1.5 spaces for each such house where its gross floor area is not less than 160 square metres but less than 220 square metres, provided that if the number of spaces to be provided under this sub-clause (a)(i)(II)(A) is a decimal number, the same shall be rounded up to the next whole number; and

(B) two spaces for each such house where its gross floor area is not less than 220 square metres.

For the purposes of this sub-clause (a)(i), the decision of the Director as to what constitutes a detached, semi-detached or terraced house and whether each such house constitutes or is intended for use as a single family residence shall be final and binding on the Purchaser.

(ii) For the purpose of sub-clause (a)(i)(I) of this Special Condition, the total number of spaces to be provided shall be the aggregate of the respective number of spaces calculated by reference to the respective size of each residential unit set out in the table in sub-clause (a)(i)(I) of this Special Condition. For the purpose of these Conditions, the term “size of each residential unit” in terms of gross floor area shall mean the sum of (I) and (II) below:

(I) the gross floor area in respect of a residential unit exclusively used and enjoyed by the resident of that unit, which shall be measured from the exterior of the enclosing walls or parapet of such unit except where such enclosing walls separate two adjoining units in which case the measurement shall be taken from the middle of those walls, and shall include the internal partitions and columns within such unit, but, for the avoidance of doubt, shall exclude all floor area within such unit which is not taken into account for the calculation of gross floor area stipulated in Special Condition No. (5)(c) hereof; and

(II) the pro-rata gross floor area of the Residential Common Area (as hereinafter defined) in respect of a residential unit and in so calculating, the total gross floor area of residential common area, which is for common use and benefit of the residents of the building or buildings erected or to be erected on the Lot, outside the enclosing walls of the residential units but, for the avoidance of doubt, excluding all floor area which are not taken into account for the calculation of the gross floor area stipulated in Special Condition No. (5)(c) hereof (which residential common area is hereinafter referred to as “the Residential Common Area”) shall be apportioned to a residential unit by the following formula:

$$\frac{\text{The total gross floor area of the Residential Common Area} \times \text{The gross floor area in respect of a residential unit as calculated under sub-clause (a)(ii)(I) of this Special Condition}}{\text{The total gross floor area of all residential units as calculated under sub-clause (a)(ii)(I) of this Special Condition}}$$

(iii) Additional spaces for the parking of motor vehicles licensed under the Road Traffic Ordinance, any regulations made thereunder and any amending legislation, and belonging to the bona fide guests, visitors or invitees of the residents of the building or buildings erected or to be erected on the Lot shall be provided, subject to a minimum of two spaces being provided, at the following rates:

(I) if more than 75 residential units are provided in any block of residential units erected or to be erected on the Lot, at a rate of one space for every such block of residential units; or

(II) at such other rates as may be approved by the Director.

For the purpose of this sub-clause (a)(iii), a detached, semi-detached or terraced house which is intended for use as a single family residence shall not be regarded as a block of residential units or a residential unit. The decision of the Director as to what constitutes a detached, semi-detached or terraced house and whether each such house constitutes or is intended for use as a single family residence shall be final and binding on the Purchaser.

(iv) The spaces provided under sub-clauses (a)(i)(I) and (a)(iii) (as may be varied under Special Condition No. (22) hereof) and (a)(i)(II) of this Special Condition shall not be used for any purpose other than those respectively set out in sub-clauses (a)(i) and (a)(iii) of this Special Condition and in particular the said spaces shall not be used for the storage, display or exhibiting of motor vehicles for sale or otherwise or for the provision of car cleaning and beauty services.

(b) (i) Out of the spaces provided under sub-clauses (a)(i)(I) and (a)(iii) (as may be varied under Special Condition No. (22) hereof) and (a)(i)(II) of this Special Condition, the Purchaser shall reserve and designate such number of spaces for the parking of motor vehicles by disabled persons as defined in the Road Traffic Ordinance, any regulations made thereunder and any amending legislation (which spaces to be so reserved and designated are hereinafter referred to as “the Parking Spaces for the Disabled Persons”) as the Building Authority may require and approve provided that a minimum of one space shall be so reserved and designated out of the spaces provided under sub-clause (a)(iii) of this Special Condition (as may be varied under Special Condition No. (22) hereof) and that the Purchaser shall not designate or reserve all of the spaces provided under sub-clause (a)(iii) of this Special Condition (as may be varied under Special Condition No. (22) hereof) to become the Parking Spaces for the Disabled Persons.

(ii) The Parking Spaces for the Disabled Persons shall not be used for any purpose other than for the parking of motor vehicles by disabled persons as defined in the Road Traffic Ordinance, any regulations made thereunder and any amending legislation, and belonging to the residents of the building or buildings erected or to be erected on the Lot and their bona fide guests, visitors or invitees and in particular the said spaces shall not be used for the storage, display or exhibiting of motor vehicles for sale or otherwise or for the provision of car cleaning and beauty services.

(c) (i) Spaces shall be provided within the Lot to the satisfaction of the Director for the parking of motor cycles licensed under the Road Traffic Ordinance, any regulations made thereunder and any amending legislation, and belonging to the residents of the building or buildings erected or to be erected on the Lot and their bona fide guests, visitors or invitees (hereinafter referred to as “the Motor Cycle Parking Spaces”) at a rate of 10 percent of the total number of spaces required to be provided under sub-clauses (a)(i)(I) and (a)(iii) (as may be varied under Special Condition No. (22) hereof) of this Special Condition unless the Director consents to another rate. If the number of spaces to be provided under this sub-clause (c)(i) is a decimal number, the same shall be rounded up to the next whole number.

(ii) The Motor Cycle Parking Spaces (as may be varied under Special Condition No. (22) hereof) shall not be used for any purpose other than for the purpose set out in sub-clause (c)(i) of this Special Condition and in particular the said spaces shall not be used for the storage, display or exhibiting of motor vehicles for sale or otherwise or for the provision of car cleaning and beauty services.

(d) (i) Except the Parking Spaces for the Disabled Persons, each of the spaces provided under sub-clauses (a)(i)(I) and (a)(iii) (as may be varied under Special Condition No. (22) hereof) and (a)(i)(II) of this Special Condition shall measure 2.5 metres in width and 5.0 metres in length with a minimum headroom of 2.4 metres.

(ii) The dimensions of each of the Parking Spaces for the Disabled Persons shall be as the Building Authority may require and approve.

(iii) Each of the Motor Cycle Parking Spaces (as may be varied under Special Condition No. (22) hereof) shall measure 1.0 metre in width and 2.5 metres in length with a minimum headroom of 2.4 metres or such other minimum headroom as may be approved by the Director.”

10. Special Condition No. (21) of the Land Grant stipulates that:-

“(a) Spaces shall be provided within the Lot to the satisfaction of the Director for the loading and unloading of goods vehicles at a rate of one space for every 800 residential units or part thereof in the building or buildings erected or to be erected on the Lot or at such other rates as may be approved by the Director subject to a minimum of one loading and unloading space for each block of residential units erected or to be erected on the Lot, such loading and

## SUMMARY OF LAND GRANT

### 批地文件的摘要

unloading space to be located adjacent to or within each block of residential units. For the purpose of this sub-clause (a), a detached, semi-detached or terraced house which is intended for use as a single family residence shall not be regarded as a block of residential units or a residential unit. The decision of the Director as to whether each such house constitutes or is intended for use as a single family residence shall be final and binding on the Purchaser.

- (b) Each of the spaces provided under sub-clause (a) of this Special Condition shall measure 3.5 metres in width and 11.0 metres in length with a minimum headroom of 4.7 metres. Such spaces shall not be used for any purpose other than for the loading and unloading of goods vehicles in connection with the building or buildings erected or to be erected on the Lot.”

#### 11. Special Condition No. (24) of the Land Grant stipulates that:-

“(a) Notwithstanding that these Conditions shall have been observed and complied with to the satisfaction of the Director, the Residential Parking Spaces and the Motor Cycle Parking Spaces shall not be:

(i) assigned except

(I) together with undivided shares in the Lot giving the right of exclusive use and possession of a residential unit or units in the building or buildings erected or to be erected on the Lot; or

(II) to a person who is already the owner of undivided shares in the Lot with the right of exclusive use and possession of a residential unit or units in the building or buildings erected or to be erected on the Lot; or

(ii) underlet except to residents of the residential units in the building or buildings erected or to be erected on the Lot.

Provided that in any event not more than three in number of the total of the Residential Parking Spaces and the Motor Cycle Parking Spaces shall be assigned to the owner or underlet to the resident of any one residential unit in the building or buildings erected or to be erected on the Lot. For the avoidance of doubt, a detached, semi-detached or terraced house which is intended for use as a single family residence shall be regarded as a residential unit referred to in this sub-clause (a). The decision of the Director as to whether a detached, semi-detached or terraced house constitutes or is intended for use as a single family residence shall be final and binding on the Purchaser.

- (b) Notwithstanding sub-clause (a) of this Special Condition, the Purchaser may, with the prior written consent of the Director, assign all the Residential Parking Spaces and the Motor Cycle Parking Spaces as a whole, but only to a wholly-owned subsidiary company of the Purchaser.
- (c) Sub-clause (a) of this Special Condition shall not apply to an assignment, underletting, mortgage or charge of the Lot as a whole.
- (d) Sub-clauses (a) and (b) of this Special Condition shall not apply to the Parking Spaces for the Disabled Persons.”

#### 12. Special Condition No. (28) of the Land Grant stipulates that:-

“(a) The Purchaser acknowledges that there are existing graves, structures and squatters, including but not limited to the licence structures located at the places as shown and marked “LICENCE No. 7531” and “LICENCE No.Z0087” on the plan annexed hereto, on the Government land adjacent to the Lot (hereinafter collectively referred to as “the Graves and Licence Areas”).

(b) Throughout the term hereby agreed to be granted, the Purchaser shall at his own expense and in all respects to the satisfaction of the Director permit the Government and all members of the public at all times a free and unobstructed right of way on foot or by wheelchair on, along, over, by and through both:

(i) the existing passage within the Lot as shown coloured pink hatched green on the plan annexed hereto; and

(ii) such other part or parts of the Lot as the Director shall approve or require

for ingress, egress and regress to and from the Graves and Licence Areas and Lai Ping Road as shown and marked on the plan annexed hereto (which existing passage referred to in sub-clause (b)(i) of this Special Condition and such other part or parts of the Lot as the Director shall approve or require under sub-clause (b)(ii) of this Special Condition are hereinafter collectively referred to as “the Public Access”).

(c) The Purchaser shall at his own expense and in all respects to the satisfaction of the Director lay, form, pave, maintain, uphold, repair and manage the Public Access in accordance with any requirements as the Director may impose from time to time. The alignment of the Public Access shall be as decided by the Director in writing from time to time. The width of the Public Access shall not be less than 2.2 metres.

(d) Subject to the prior written approval of the Director, the Purchaser may at his own expense and in all respects to the satisfaction of the Director divert or replace the Public Access within the Lot in compliance with any requirements as shall be imposed by the Director (such diverted or replaced access is hereinafter referred to as “Replacement Access”). Prior to completion of the Replacement Access, the Purchaser shall at all times maintain a free and unobstructed use of the Public Access by the Government and the members of the public in accordance with sub-clause (a) of this Special Condition. The Purchaser shall indemnify and keep indemnified the Government from and against all liabilities, claims, costs, demands, actions, charges, damages or other proceedings whatsoever arising whether directly or indirectly out of or in connection with the Purchaser’s non-fulfilment of his obligations or in the carrying out of any works under this sub-clause (d).

(e) Upon completion of the Replacement Access, the Purchaser shall permit the Government and all members of the public at all times and for all lawful purposes free of charge and without any interruption to pass or repass on foot or by wheelchair along, to, from, by through, over, up and down the Replacement Access for ingress, egress and regress to and from the Graves and Licence Areas and Lai Ping Road. The Purchaser shall at his own expense and in all respects to the satisfaction of the Director manage, maintain, uphold and repair the Replacement Access in accordance with any requirements as the Director may impose from time to time.

(f) The Government will accept no responsibility or liability for any damage, nuisance or disturbance whatsoever caused to or suffered by the Purchaser by reason of the provision, maintenance and use of the Public Access or the Replacement Access, if any. The Purchaser shall indemnify and keep indemnified the Government from and against all liabilities, claims, costs, demands, actions or other proceedings whatsoever arising whether directly or indirectly out of or in connection with the provision and use and subsequent change, diversion or removal of the Public Access or the Replacement Access.

(g) It is hereby expressly agreed, declared and provided that by imposing the obligation on the part of the Purchaser contained in sub-clauses (b) and (e) of this Special Condition, neither the Purchaser intends to dedicate nor the Government consents to any dedication of the Public Access (including its replacement access under sub-clause (d) of this Special Condition) or any part or parts thereof to the public for the right of passage.

(h) It is expressly agreed and declared that the obligation on the part of the Purchaser contained in sub-clauses (b) and (e) of this Special Condition will give rise to no expectation of, or claim for or in respect of, any concession or right in respect of additional site coverage or plot ratio whether under Regulation 22 (1) of the Building (Planning) Regulations, any amendment thereto, substitution therefor, or otherwise and for the avoidance of doubt the Purchaser expressly waives any and all claims in respect of or for any concession in respect of, or right to, additional site coverage or plot ratio under Regulation 22(1) of the Building (Planning) Regulations, any amendment thereto or substitution therefor.”

#### 13. Special Condition No. (29) of the Land Grant stipulates that:-

“(a) The Purchaser acknowledges that there are some electricity cables, overhead lines and electric posts (hereinafter referred to as “the Utilities”) running on, over, across, through or under the Lot. The Government will accept no responsibility or liability for any loss, damage, nuisance or disturbance caused to or suffered by the Purchaser by reason of the presence of the Utilities. The Purchaser hereby indemnifies and shall keep indemnified the Government from and against all liabilities, claims, costs, demands, actions or other proceedings whatsoever arising whether directly or indirectly out of or in connection with the presence and use of or damages to the Utilities.

(b) Subject to the prior written approval of the Director, the Purchaser may at his own expense divert the Utilities in compliance with any conditions as shall be imposed or approved by the Director. In the event of any such diversion, the Purchaser shall indemnify and keep indemnified the Government from and against all claims, actions, charges or damages whatsoever arising therefrom.”

#### 14. Special Condition No. (31) of the Land Grant stipulates that:-

“(a) Where there is or has been any cutting away, removal or setting back of any land, or any building-up or filling-in or any slope treatment works of any kind whatsoever, whether with or without the prior written consent of the Director, either within the Lot or on any Government land, which is or was done for the purpose of or in connection with the formation, levelling or development of the Lot or any part thereof or any other works required to be done by the Purchaser under these Conditions, or for any other purpose, the Purchaser shall at his own expense carry out and

## SUMMARY OF LAND GRANT

### 批地文件的摘要

construct such slope treatment works, retaining walls or other support, protection, drainage or ancillary or other works as shall or may then or at any time thereafter be necessary to protect and support such land within the Lot and also any adjacent or adjoining Government or leased land and to obviate and prevent any falling away, landslip or subsidence occurring thereafter. The Purchaser shall at all times during the term hereby agreed to be granted maintain at his own expense the said land, slope treatment works, retaining walls or other support, protection, drainage or ancillary or other works in good and substantial repair and condition to the satisfaction of the Director.

- (b) Nothing in sub-clause (a) of this Special Condition shall prejudice the Government's rights under these Conditions, in particular Special Condition No. (30) hereof.
- (c) In the event that as a result of or arising out of any formation, levelling, development or other works done by the Purchaser or owing to any other reason, any falling away, landslip or subsidence occurs at any time, whether in or from any land within the Lot or from any adjacent or adjoining Government or leased land, the Purchaser shall at his own expense reinstate and make good the same to the satisfaction of the Director and shall indemnify the Government, its agents and contractors from and against all costs, charges, damages, demands and claims whatsoever which shall or may be made, suffered or incurred through or by reason of such falling away, landslip or subsidence.
- (d) In addition to any other rights or remedies herein provided for breach of any of these Conditions, the Director shall be entitled by notice in writing to call upon the Purchaser to carry out, construct and maintain the said land, slope treatment works, retaining walls, or other support, protection, and drainage or ancillary or other works or to reinstate and make good any falling away, landslip or subsidence, and if the Purchaser shall neglect or fail to comply with the notice to the satisfaction of the Director within the period specified therein, the Director may forthwith execute and carry out any necessary works and the Purchaser shall on demand repay to the Government the cost thereof, together with any administrative or professional fees and charges."

#### 15. Special Condition No. (33) of the Land Grant stipulates that:-

"Where prestressed ground anchors have been installed, upon development or redevelopment of the Lot or any part thereof, the Purchaser shall at his own expense carry out regular maintenance and regular monitoring of the prestressed ground anchors throughout their service life to the satisfaction of the Director and shall supply to the Director such reports and information on all such monitoring works as the Director may from time to time in his absolute discretion require. If the Purchaser shall neglect or fail to carry out the required monitoring works, the Director may forthwith execute and carry out the monitoring works and the Purchaser shall on demand repay to the Government the cost thereof."

#### 16. Special Condition No. (36) of the Land Grant stipulates that:-

- "(a) The Purchaser shall construct and maintain at his own expense and to the satisfaction of the Director such drains and channels, whether within the boundaries of the Lot or on Government land, as the Director may consider necessary to intercept and convey into the nearest stream-course, catchpit, channel or Government storm-water drain all storm-water or rain-water falling or flowing on to the Lot, and the Purchaser shall be solely liable for and shall indemnify the Government and its officers from and against all actions, claims and demands arising out of any damage or nuisance caused by such storm-water or rain-water.
- (b) The works of connecting any drains and sewers from the Lot to the Government storm-water drains and sewers, when laid and commissioned, may be carried out by the Director who shall not be liable to the Purchaser for any loss or damage thereby occasioned and the Purchaser shall pay to the Government on demand the cost of such connection works. Alternatively, the said connection works may be carried out by the Purchaser at his own expense to the satisfaction of the Director and in such case any section of the said connection works which is constructed within Government land shall be maintained by the Purchaser at his own cost and upon demand be handed over by the Purchaser to the Government for future maintenance thereof at the expense of the Government and the Purchaser shall pay to the Government on demand the cost of the technical audit in respect of the said connection works. The Director may, upon failure of the Purchaser to maintain any section of the said connection works which is constructed within Government land, carry out such maintenance works as he considers necessary and the Purchaser shall pay to the Government on demand the cost of such works."

#### 17. Special Condition No. (37) of the Land Grant stipulates that:

- "(a) The Purchaser acknowledges that as at the date of this Agreement, there are retaining wall, structure or structures supporting the adjoining Lai Ping Road in the vicinity of the area shown coloured pink hatched brown on the plan annexed hereto (hereinafter referred to as "the Pink Hatched Brown Area" and which retaining wall, structure or structures are hereinafter collectively referred to as "the Retaining Wall").

- (b) The Purchaser shall take or cause to be taken all proper and adequate care, skill and precautions at all times, and particularly when carrying out any works upon, over, under, in or within the Pink Hatched Brown Area (hereinafter referred to as "the said Works") to avoid causing any damage, disturbance or interference to the Retaining Wall. The Purchaser shall at his own expense and within such time limit as may be specified by the Director repair, make good and reinstate the Retaining Wall in all respects to the satisfaction of the Director any damage, disturbance or interference caused to the Retaining Wall in any manner arising out of the said Works. The Purchaser shall prior to carrying out the said Works at his own expense take such precautions and measures as may be required by the Director to ensure that the Retaining Wall will not be damaged, disturbed or interfered with.
- (c) For the purpose of this Special Condition, the decision of the Director as to what constitutes the Retaining Wall shall be final and binding on the Purchaser.
- (d) The Purchaser shall throughout the term hereby agreed to be granted permit the Government, the Director and his officers, contractors, agents and any persons authorized by it or them and its or their workmen the right of ingress, egress and regress to, from and through the Pink Hatched Brown Area at all reasonable times with or without tools, equipment, plant, machinery or motor vehicles for the purposes of inspecting, repairing or maintaining the Retaining Wall or the carrying out of any works which the Director may consider necessary in connection with the Retaining Wall.
- (e) The Government, the Director and his officer, contractors, agents and any persons authorized by it or them and its or their workmen shall have no liability in respect of any loss, damage, nuisance or disturbance whatsoever caused to or suffered by the Purchaser or any person whether arising out of or incidental to the exercise by it or them of the rights conferred under sub-clause (d) of this Special Condition, and no claim whatsoever shall be made against it or them by the Purchaser in respect of any such loss, damage, nuisance or disturbance."

#### 18. Special Condition No. (40) of the Land Grant stipulates that:

"No grave or columbarium shall be erected or made on the Lot, nor shall any human remains or animal remains whether in earthenware jars, cinerary urns or otherwise be interred therein or deposited thereon."

#### Note :

For full details, please refer to the Land Grant. Full script of the Land Grant is available for free inspection upon request at the sales office during opening hours and copies of the Land Grant can be obtained upon paying necessary photocopying charges.



## SUMMARY OF LAND GRANT

### 批地文件的摘要

1. 發展項目建於沙田市地段第578號(「該地段」)，並根據2013年10月17日訂立的新批地文件第21670號(經一份日期為2016年1月5日並在土地註冊處以註冊摘要編號16011402340012號登記的批准函修改或修訂)(統稱「批地文件」)持有。

2. 該地段的批出租期為由2013年10月17日起計50年。

3. 批地文件一般條款第7條規定：

「(a) 買方須在整個租期期間按本文件對已建或重建建築物(該詞指本一般條款第(b)分條預期的重建工程)：

(i) 按經批准的設計、配置及任何經批准建築圖則保養一切建築物，不得對其作出修訂或更改；及

(ii) 保養按本文件或今後按任何修訂合同已建或將會興建的一切建築物處於修繕妥當及良好的保養狀態直至租約結束或提前終止交還為止。

(b) 倘若在租期的任何時候清拆當時在該地段或其中任何部分上面的任何建築物，買方須興建相同類型和不少於其總樓面面積的品質良好的建築物或地政總署署長(「署長」)批准的類型及價值的建築物作為代替。如果進行上述清拆，買方須在上述清拆的一個曆月內向署長申請同意進行重新發展該地段的建築工程。當收到上述同意後必須在三個曆月內開展重建的必要工程及在署長規定的期限內以署長滿意的方式完成重建。」

4. 批地文件特別條款第(3)條規定：

「買方應根據本文件及所有在香港已生效或可能在任何時候生效有關建築、衛生及規劃的條例、附例及規例搭建建築物以發展該地段，該等建築物需於2019年6月30日或之前完工並適合被佔用。」

5. 批地文件特別條款第(4)條規定：

「該地段或其中任何部分或在其上已建或擬建的任何建築物或建築物部份不得用作私人住宅以外的任何用途。」

6. 批地文件特別條款第(9)條規定：

「(a) 經署長書面批准，買方可在該地段內搭建、建築及提供康樂設施及其輔助設施(以下簡稱「設施」)。設施的類型、面積、設計、高度及配置亦須經署長的預先書面批准。

(b) 在計算本文件特別條款第(5)(c)條指定的所有總樓面面積時，除了特別條款第(39)(d)條規定外，按本特別條款第(a)分條在該地段內提供的設施之任何部分，只要是供在該地段已建或擬建的住宅大廈的所有住戶和他們的真正訪客共同使用與享用就不列入上述計算，而該設施的餘下部分若署長認為不屬於上述使用，則應列入計算。

(c) 倘若設施任何部分獲豁免列入計算本特別條款第(b)分條的總樓面面積(以下簡稱「獲豁免設施」)：

(i) 獲豁免設施須指定為並構成本文件特別條款第(17)(a)(v)條提及的公用地方；

(ii) 買方須自費保養獲豁免設施處於修繕妥當的狀態並操作獲豁免設施，使署長滿意；及

(iii) 獲豁免設施僅供該地段上已建或擬建的住宅大廈的住戶和他們的真正訪客使用，其他人士不得使用。

(d) 如該地段發展為單一家庭住所的用途，本特別條款第(b)及(c)分條將不適用。署長就該地段是否發展為單一家庭住所的用途的決定將是最終及對買方有約束力。」

7. 批地文件特別條款第(10)條規定：

「未經署長事先書面同意，不得移除或干擾該地段或毗連範圍內的樹木。署長在發出書面同意時，可施加他認為合適有關樹木進行移植、補償性景觀美化工程或再植的條件。」

8. 批地文件特別條款第(11)條規定：

「(a) 買方須自費提交一份按本特別條款第(b)分條規定在該地段內提供美化環境工程並標示其位置、配置及布局的美化環境總藍圖給署長審批。未取得署長對美化環境總藍圖的批准和對特別條款第(10)條要求保育樹木的建議授予同意(如要求)之前，不得對該地段或其中任何部分展開任何平整工程。

(b) (i) 美化環境總藍圖須以1:500或更大比例製作並載有美化環境建議的資料，包括普查與處理現有樹木、地盤布局及構建水平、建築發展的概念形式、軟硬環境美化區域佈局說明及署長可能要求的其他資料。

(ii) 該地段中不少於20%範圍須種植樹木、灌木或其他植物。

(iii) 本特別條款第(b)(ii)分條提及的20%中不少於50%須在署長自行酌情決定的位置或水平提供(以下簡稱「綠化範圍」)，以便行人可看見或進入該地段的任何人士可接近該綠化範圍。

(iv) 署長對買方建議的美化環境工程屬於本特別條款第(b)(ii)分條提及的20%之決定是最終的及約束買方。

(v) 署長可自行酌情接受買方建議用其他非種植裝飾代替種植樹木、灌木或其他植物。

(c) 買方須按已批准的美化工程總藍圖則自費美化該地段，在一切方面使署長滿意。未經署長的預先書面批准，不得對已批准美化工程總藍圖則進行修改、改變、更改、修訂或代替。

(d) 買方須在其後自費保持與保養美化工程處於安全、清潔、整齊、整潔及健康狀態，在一切方面使署長滿意。

(e) 按本特別條款美化的範圍須指定為並構成本文件特別條款第(17)(a)(v)條提及的公用地方。

(f) 倘若該地段的開發僅作為單獨家庭住宅使用，本特別條款第(b)(iii)和(c)分條不適用。署長對該地段的開發是否作為單獨家庭住宅用途的決定是最終的及約束買方。」

9. 批地文件特別條款第(20)條規定：

「(a) (i) 必須按下列比率在該地段提供停車位，供根據《道路交通條例》、其下的任何規例及任何修訂法例獲發牌並屬於該地段上已建或擬建的建築物之住戶和他們的真正來賓、訪客或被邀請使用者的車輛停泊(以下簡稱「住宅停車位」)，使署長滿意：

(I) 在該地段內提供一棟或多棟住宅單位大廈(擬供單獨家庭住宅用途的獨立屋、半獨立屋或排屋除外)時，須按以下表格列明該地段已建或擬建的住宅單位各自面積計算的比率計算，除非署長同意不同於下列表格的比率或數目：

每個住宅單位的面積	擬提供的住宅停車位數目
少於40平方米	每13.3個住宅單位或其中部分1個停車位
不少於40平方米，但少於70平方米	每8個住宅單位或其中部分1個停車位
不少於70平方米，但少於100平方米	每3.2個住宅單位或其中部分1個停車位
不少於100平方米，但少於160平方米	每1.6個住宅單位或其中部分1個停車位
不少於160平方米，	1個住宅單位1個停車位

(II) 如果在該地段內提供獨立屋、半獨立屋或排屋作為單獨家庭住宅用途，按以下比率：

(A) 每棟總樓面面積少於160平方米的房屋提供1個停車位和每棟總樓面面積不少於160平方米，但少於220平方米的房屋提供1.5個停車位，但是如果按本特別條款第(a)(i)(II)(A)分條提供的停車位數目是小數，該數目將被完全向上進位至下一個整數；及



(B) 每棟總樓面面積不少於220平方米的房屋提供2個停車位。

在本第(a)(i)分條中，署長對獨立屋、半獨立屋或排屋的定義和每一該等房屋是否或擬供一個單獨家庭住宅用途的決定是最終的及約束買方。

(ii) 在本特別條款第(a)(i)(I)分條中擬提供的停車位總數目應是根據本特別條款第(a)(i)(I)分條的表格列明每個住宅單位的面積計算各個停車位數目的總數。在本文件中，「每個住宅單位面積」一詞在總樓面面積方面指以下第(I)及(II)的總數：

(I) 該單位住戶獨家使用與享用的住宅單位總樓面面積，從該單位的圍牆或護牆外面，除了分隔2個連接單位的圍牆，在該種情況下，須從該等牆壁的中心線量度並包括該單位內的內部分隔牆及支柱，但是為免存疑，不包括該單位內沒有列入本文件特別條款第(5)(c)條指定的總樓面面積的所有樓面面積；及

(II) 與每個住宅單位成比例的住宅公用地方(按下文界定)的總樓面面積，即在住宅單位外圍牆外面供該地段已建或擬建建築物的所有住戶共同使用與享用的住宅公用地方的所有總樓面面積(該住宅公用地方在下文簡稱「住宅公用地方」)，為免存疑，不包括沒有列入計算本文件特別條款第(5)(c)條指定總樓面面積的所有樓面面積，在計算時須按下列公式分攤給住宅單位：

$$\text{住宅公用地方的所有總樓面面積} \times \frac{\text{按本特別條款第(a)(ii)(I)分條計算的有關住宅單位的總樓面面積}}{\text{按本特別條款第(a)(ii)(I)分條計算所有住宅單位的總樓面面積}}$$

(iii) 必須按下列比率提供額外的停車位，供根據《道路交通條例》、其下的任何規例及任何修訂法例獲發牌並屬於該地段上已建或擬建的建築物之住戶的真正來賓、訪客或被邀請使用者的車輛停泊，惟須提供至少2個停車位：

(I) 如果該地段已建或擬建任何住宅單位大廈提供超過75個住宅單位，按每座住宅單位大廈提供1個停車位之比率；或

(II) 署長批准的其他比率，

在本特別條款第(a)(iii)分條中，擬供一個單獨家庭住宅用途的獨立屋、半獨立屋或排屋不能視為一座住宅大廈。署長對獨立屋、半獨立屋或排屋的定義或每一該等房屋是否或擬供一個單獨家庭住宅用途的決定是最終的及約束買方。

(iv) 按本特別條款第(a)(i)(I)和第(a)(iii)分條(可按本文件特別條款第(22)條修訂)及第(a)(i)(II)分條提供的停車位不得用作本特別條款第(a)(i)和第(a)(iii)分條分別指定以外的任何用途，及特別是上述停車位不得用作汽車儲存、陳列或展示或作汽車出售或其他用途或提供汽車清潔及美容服務。

(b) (i) 按本特別條款第(a)(i)(I)和第(a)(iii)分條(可按本文件特別條款第(22)條修訂)及第(a)(i)(II)分條提供的停車位中，買方須按建築事務監督要求及批准的數量保留與指定停車位，供《道路交通條例》、其下的規例或任何修訂法例界定的殘疾人士停泊車輛(上述保留與指定的停車位在下文稱為「殘疾人士停車位」)，惟必須從按本特別條款第(a)(iii)分條(可按本文件特別條款第(22)條修訂)提供的停車位中保留與指定至少1個停車位。買方不能保留或指定按本特別條款第(a)(iii)分條(可按本文件特別條款第(22)條修訂)提供的所有停車位作為殘疾人士停車位。

(ii) 殘疾人士停車位不得用作《道路交通條例》、其下的規例或任何修訂法例界定的殘疾人士並屬於該地段上已建或擬建的建築物之住戶和他們的真正來賓、訪客或被邀請使用者停泊車輛以外的任何用途，及特別是上述停車位不得用作汽車儲存、陳列或展示或作汽車出售或其他用途或提供汽車清潔及美容服務。

(c) (i) 除署長批准其他比率外，買方必須按本特別條款第(a)(i)(I)和第(a)(iii)分條(可按本文件特別條款第(22)條修訂)要求提供的總停車位數目中的10%之比率在該地段內提供停車位，供根據《道路交通條例》、其下的任何規例及任何修訂法例獲發牌並屬於該地段上已建或擬建的建築物之住戶和他們的真正來賓、訪客或被邀請使用者的電單車停泊(以下簡稱「電單車停車位」)，使署長滿意，但是如果按本特別條款第(c)(i)分條提供的停車位數目是小數，該數目將被完全向上進位至下一個整數。

(ii) 電單車停車位(可按本文件特別條款第(22)條修訂)不得用作本特別條款第(c)(i)分條指定以外的任何用途，及特別是上述停車位不得用作汽車儲存、陳列或展示或作汽車出售或其他用途或提供汽車清潔及美容服務。

(d) (i) 除保留給殘疾人士使用的停車位外，按本特別條款第(a)(i)(I)和第(a)(iii)分條(可按本文件特別條款第(22)條修訂)及第(a)(i)(II)分條提供的每個停車位的尺寸應為：2.5米闊 × 5.0米長 × 至少樓底高度2.4米。

(ii) 殘疾人士使用的停車位須按建築事務監督要求與批准的尺寸提供。

(iii) 每個電單車停車位(可按本文件特別條款第(22)條修訂)的尺寸應為：1.0米闊 × 2.5米長 × 至少樓底高度2.4米或署長可批准的其他最少樓底高度。」

10. 批地文件特別條款第(21)條規定：

「(a) 必須按該地段已建或擬建的建築物每800個住宅單位或其中部分提供一個上落貨空間之比率或署長可批准的其他比率在該地段內指供貨車上落貨用途，使署長滿意，惟在該地段已建或擬建的每座住宅單位大廈須至少有一個上落貨空間，該上落貨空間須設在每座住宅單位大廈旁邊或之內。在本第(a)分條中，擬供單獨家庭住宅用途的獨立屋、半獨立屋及排屋不能視作一座住宅單位大廈或一個住宅單位。署長對該等房屋是否或擬供一個單獨家庭住宅用途的決定是最終的及約束買方。

(b) 按本特別條款第(a)分條提供的上落貨空間尺寸應為：3.5米闊 × 11米長 × 至少樓底高度4.7米。上述上落貨空間不能用作該地段已建或擬建的建築物有關的上落客貨以外的任何用途。」

11. 批地文件特別條款第(24)條規定：

「(a) 即使已遵守本文件使署長滿意，住宅停車位及電單車停車位不能

(i) 轉讓，除非

(I) 連同該地段的不分割份數及獨家使用及管有該地段已建或擬建的大廈住宅單位的權利；或

(II) 給已經是該地段的不分割份數及獨家使用及管有該地段已建或擬建的大廈住宅單位的權利的業主之人士；或

(ii) 分租，除非給該地段已建或擬建的大廈住宅單位的住戶，

但是在任何情況下，不得將超過3個住宅停車位和電單車停車位轉讓或分租予該地段已建或擬建大廈任何一個住宅單位的業主或住戶。為免存疑，擬供一個單獨家庭住宅用途的獨立屋、半獨立屋或排屋應被視為本特別條款第(a)分條提及的住宅單位。署長對獨立屋、半獨立屋或排屋的定義和該等房屋是否或擬供一個單獨家庭住宅用途的決定是最終的及約束買方。

(b) 即使本特別條款第(a)分條規定，經署長的預先書面同意，買方只可以轉讓整個所有住宅停車位及電單車停車位為一整體予買方全資擁有的附屬公司。

(c) 本特別條款第(a)分條不適用於轉讓、分租、按揭或抵押整個地段。

(d) 本特別條款第(a)和(b)分條不適用於殘疾人士停車位。」



## 12. 批地文件特別條款第(28)條規定：

- 「(a) 買方承認目前在該地段毗鄰的政府土地上存在墳墓、構築物及寮屋，包括但不限於在本批地文件附錄的圖則上顯示並標明「LICENCE No. 7531」和「LICENCE No. Z0087」的位置上興建的許可構築物(以下統稱「墳墓及許可證區」)。
- (b) 在本文件授予的整個租期期間，買方須自費准許政府和一切公眾人士享有道路權自由及暢通無阻地步行或推輪椅經過及再經過下列地方，在一切方面使署長滿意：
- (i) 在本文件附錄的圖則上用粉紅色加綠斜線顯示該地段內的現有通道；及
- (ii) 署長批准或要求該地段的其他部分
- 以便出入、經過及再經過本文件附錄的圖則上顯示並標明的墳墓及許可證區和麗坪路(本特別條款第(b)(i)分條提及的現有通道和署長按本特別條款第(b)(ii)分條批准或要求該地段的其他部分在下文統稱「公共通道」)。
- (c) 買方須按署長可不時施加的任何要求自費鋪設、塑造、平整、保養、維護、維修及管理公共通道，在一切方面使署長滿意。公共通道的定線須由署長不時書面決定。公共通道的闊度不能少於2.2米。
- (d) 經署長的預先書面批准，買方可按署長施加的任何要求自費更改或代替在該地段內的公共通道，在一切方面使署長滿意(上述更改或代替的通道在下文稱為「代替通道」)。在完成代替通道之前，買方須按本特別條款第(a)分條規定在任何時候保持公共通道供政府和公眾自由及暢通無阻地使用。買方須就其沒有履行其職責或按本(d)分條進行任何工程直接或間接產生的一切責任、索償、費用、要求、訴訟、起訴、損害賠償或其他司法程序彌償及保障政府。
- (e) 在完成代替通道後，買方須准許政府和公眾在任何時候為了一切合法目的免費及暢通無阻地步行或推輪椅經過及再經過代替通道，以便出入、經過及再經過墳墓及許可證區和麗坪路。買方須按署長可不時施加的任何要求自費管理、保養、維護及維修代替通道，在一切方面使署長滿意。
- (f) 政府毋須對提供、保養及使用公共通道或代替通道造成買方蒙受任何損害、滋擾、干擾(如有)承擔任何責任或義務。買方須就提供、使用和其後改變、分道或移走公共通道或代替通道直接或間接產生的一切責任、索償、費用、要求、訴訟或其他司法程序彌償及保障政府。
- (g) 特此明文同意、聲明及規定，就買方承擔本特別條款第(b)和(e)分條的責任，買方並非擬奉獻，而政府亦不是同意奉獻公共通道(包括本特別條款第(d)分條下的代替通道)或其中任何部分給公眾通行的權利。
- (h) 特此明文同意及聲明，買方承擔本特別條款第(b)和(e)分條提及的責任，並非期望或要求根據《建築物(規劃)規例》第22(1)條及其任何修訂或代替條例規定享有額外上蓋面積或地積比的任何優惠或權利。為免存疑，買方現明確放棄基於或鑒於《建築物(規劃)規例》第22(1)條規例或其任何修訂或取代條文等所訂額外上蓋面積或地積比率特許或權利提出任何及所有索償。」

## 13. 批地文件特別條款第(29)條規定：

- 「(a) 買方承認目前在該地段之上、上面、穿過或下面有鋪設一些電纜、架空線路及電線杆(以下簡稱為「公用事業」)。政府毋須對公用事業的存在造成買方蒙受任何損失、損害、滋擾或干擾承擔任何責任或義務。買方須對公用事業的存在及其使用或損壞直接或間接產生的一切責任、索償、費用、要求、訴訟或其他司法程序彌償及保障政府。
- (b) 經署長預先書面批准，買方可按署長要求或批准的條款自費將公用事業改道。如果作出上述改道，買方須對因此產生的一切索償、訴訟、起訴或損害賠償彌償及保障政府。」

## 14. 批地文件特別條款第(31)條規定：

- 「(a) 如果任何土地被或已經被削去、移除或削減，或進行堆積或堆填或任何類型的斜坡處理工程，不論有否經署長預先書面同意，亦不論是在該土地內或任何政府土地內，旨在塑造、平整或發展該地段或其中任何部分或買方按本文件需要進行的任何其他工程或作任何其他用途，買方須自費進行與修建該等斜坡處理工程、護土牆或其他支撐物、保護物、排水或輔助工程或今後成為必要的其他工程，以便保護與支撐該地段和任何毗鄰或毗連政府土地或出租土地內的泥土，避免與防止今後發生任何塌方、山泥傾瀉或地陷。買方須在本文件授予的租期期間自費保養該土地、斜坡處理工程、護土牆或其他支撐物、保護物、排水或輔助工程或其他工程處於良好及修繕妥當的狀態，使署長滿意。
- (b) 本特別條款第(a)分條不能影響本文件，特別是批地文件特別條款第(30)條賦予政府的權利。
- (c) 倘若因為任何塑造、平整、發展或買方進行其他工程或任何其他原因造成任何時候發生塌方、山泥傾瀉或地陷，不論發生在或來自該地段任何土地或任何毗鄰或毗連政府土地或出租土地，買方須自費進行修復或彌補，使署長滿意並對上述塌方、山泥傾瀉或地陷造成政府、他的代理人及承建商蒙受、遭受或產生一切費用、收費、損害賠償、要求及索償做出彌償。
- (d) 除了批地文件規定對違反該文件的任何其他權利或濟助外，署長有權發出書面通知要求買方進行、修建及保養該土地、斜坡處理工程、護土牆或其他支撐物、保護物及排水或輔助工程或其他工程或修復與彌補任何塌方、山泥傾瀉或地陷。如果買方不理會或未能在通知指定的時期內執行該通知要求，使署長滿意，署長可立即執行與進行任何必要工程。買方須在要求時歸還政府因此產生的費用連同任何行政費或專業費用及開支。」

## 15. 批地文件特別條款第(33)條規定：

「如果在開發或重建該地段或其中任何部分時已安裝預應力地樁，買方須在預應力地樁的服務年限期間定期保養與檢查預應力地樁，使署長滿意並在署長不時自行酌情要求時提供上述檢驗工程的報告和資料給署長。如果買方不理會或未能進行上述檢驗工程，署長可立即執行與進行上述檢驗工程。買方須在要求時歸還政府因此產生的費用。」

## 16. 批地文件特別條款第(36)條規定：

- 「(a) 買方須自費建造與保養不論在該地段邊界內或署長認為必要的政府土地內的排水渠及渠道，使署長滿意，以便截斷與引導該地段的一切暴雨或雨水到最近的河道、集水井、渠道或政府雨水渠。買方須對上述暴雨或雨水造成的任何損壞或滋擾而導致的一切訴訟、索償及要求自行負責並向政府及其官員作出彌償。
- (b) 連接該地段的任何排水渠和污水渠至政府的雨水渠、排水渠及污水渠(如已建及試用)的工程可由署長進行，但署長毋須就因此產生的任何損失或損害對買方負責。買方須在要求時向政府支付上述連接工程的費用。另一選擇是該等連接工程可由買方自費進行，使署長滿意。在該種情況下，上述連接工程的任何一段若在政府土地內修建，必須由買方自費保養，直至要求時由買方移交給政府，由政府出資負責今後的保養。買方須在要求時向政府支付有關上述連接工程的技術檢查之費用。倘若買方未能保養在政府土地內修建上述任何一段的連接工程，署長可進行他認為必要的保養工程，買方須在要求時向政府支付該等工程的費用。」

17. 批地文件特別條款第(37)條規定：

- 「(a) 買方承認在本協議之日在本文件附錄的圖則上用粉紅色加棕斜線顯示附近的範圍建有護土牆、構築物以承托毗鄰麗坪路(以下簡稱為「粉紅色加棕斜線範圍」和該等護土牆或構築物在下文統稱為「護土牆」)。
- (b) 買方須在任何時候盡一切適當及足夠的細心、技巧及專注，特別是在粉紅色加棕斜線範圍之上、上面、之下、之內或內部進行任何工程時(以下簡稱為「上述工程」)，以避免對護土牆造成任何損壞、干擾或干涉。買方須在署長指定的時間內自費維修、彌補及修復上述工程以任何方式造成護土牆的任何損壞、干擾或干涉，在一切方面使署長滿意。買方在進行上述工程之前，須自費採取署長要求的預防措施及措施，確保護土牆不受到損壞、干擾或干涉。
- (c) 在本特別條款中，署長對護土牆的定義之決定是最終的及約束買方。
- (d) 買方須在本文件授予的整個租期期間准許政府、署長、他的官員、承辦商、代理人及他或他們授權的任何人士或他們的工人有權在任何合理時間內帶上或不帶工具、設備、機械、機器或車輛出入及經過粉紅色加棕斜線範圍，以便視察、維修或保養護土牆或進行署長認為保養護土牆所必要的任何工程。
- (e) 政府、署長、他的官員、承辦商、代理人及他或他們授權的任何人士或他們的工人對他們行使本特別條款第(d)分條的權利所產生或附帶對買方或任何人士造成任何損失、損害、滋擾或干擾毋須承擔任何責任，買方不能對上述任何損失、損害、滋擾或干擾向他們提出任何索償。」

18. 批地文件特別條款第(40)條規定：

「該地段內不得搭建或提供墳墓或骨灰龕，亦不准在其內或其上埋葬或存放人類遺骸或動物遺骸(不論是否用泥壇、骨灰龕或其他形式埋葬或存放)。」

註：

如欲知全部詳情，請參閱批地文件。批地文件可在售樓處的辦公時間內免費查閱並在支付必要的影印費後索取其副本。

## INFORMATION ON PUBLIC FACILITIES AND PUBLIC OPEN SPACES

### 公共設施及公眾休憩用地的資料

#### A. Facilities that are required under the land grant to be constructed and provided for the Government, or for public use

1. Description

The Public Access and the Replacement Access as referred to in Special Condition No. (28) of the Land Grant.

2. The general public has the right to use the facilities in accordance with the Land Grant.

#### B. Facilities that are required under the land grant to be managed, operated or maintained for public use at the expense of the owners of the residential properties in the Development

1. Description

The Public Access and the Replacement Access as referred to in Special Condition No. (28) of the Land Grant.

2. The general public has the right to use the facilities in accordance with the Land Grant.

3. The facilities are required to be managed, operated or maintained at the expense of the owners of the residential properties in the Development.

4. The owners of the residential properties in the Development are required to meet a proportion of the expense of managing, operating or maintaining the facilities through the management expenses apportioned to the residential properties concerned.

#### C. Open space that is required under the land grant to be managed, operated or maintained for public use at the expense of the owners of the residential properties in the Development

Not applicable.

#### D. Any part of the land (on which the Development is situated) that is dedicated to the public for the purposes of regulation 22(1) of the Building (Planning) Regulations (Cap. 123 sub. Leg. F)

Not applicable.

#### E. A plan that shows the location of those facilities and open spaces, and those parts of the land

Please see the plan in the end of this section.

#### F. Provisions of the land grant that concern those facilities and open spaces, and those parts of the land

Special Condition No. (28) of the Land Grant stipulates that:-

“(a) The Purchaser acknowledges that there are existing graves, structures and squatters, including but not limited to the licence structures located at the places as shown and marked “LICENCE No. 7531” and “LICENCE No.Z0087” on the plan annexed hereto, on the Government land adjacent to the lot (hereinafter collectively referred to as “the Graves and Licence Areas”).

(b) Throughout the term hereby agreed to be granted, the Purchaser shall at his own expenses and in all respects to the satisfaction of the Director permit the Government and all members of the public at all times a free and unobstructed right of way on foot or by wheelchair on, along, over, by and through both:

(i) the existing passage within the lot as shown coloured pink hatched green on the plan annexed hereto; and

(ii) such other part or parts of the lot as the Director shall approve or require for ingress, egress and regress to and from the Graves and Licence Areas and Lai Ping Road as shown and marked on the plan annexed hereto (which existing passage referred to in sub-clause (b)(i) of this Special Condition and such other part or parts of the lot as the Director shall approve or require under sub-clause (b)(ii) of this Special Condition are hereinafter collectively referred to as “the Public Access”).

(c) The Purchaser shall at his own expense and in all respects to the satisfaction of the Director lay, form, pave, maintain, uphold, repair and manage the Public Access in accordance with any requirements as the Director may impose from time to time. The alignment of the Public Access shall be as decided by the Director in writing from time to time. The

width of the Public Access shall not be less than 2.2 metres.

(d) Subject to the prior written approval of the Director, the Purchaser may at his own expense and in all respects to the satisfaction of the Director divert or replace the Public Access within the Lot in compliance with any requirements as shall be imposed by the Director (such diverted or replaced access is hereinafter referred to as “Replacement Access”). Prior to completion of the Replacement Access, the Purchaser shall at all times maintain a free and unobstructed use of the Public Access by the Government and the members of the public in accordance with sub-clause (a) of this Special Condition. The Purchaser shall indemnify and keep indemnified the Government from and against all liabilities, claims, costs, demands, actions, charges, damages or other proceedings whatsoever arising whether directly or indirectly out of or in connection with the Purchaser’s non-fulfilment of his obligations or in the carrying out of any works under this sub-clause (d).

(e) Upon completion of the Replacement Access, the Purchaser shall permit the Government and all members of the public at all times and for all lawful purposes free of charge and without any interruption to pass or repass on foot or by wheelchair along, to, from, by through, over, up and down the Replacement Access for ingress, egress and regress to and from the Graves and Licence Areas and Lai Ping Road. The Purchaser shall at his own expense and in all respects to the satisfaction of the Director manage, maintain, uphold and repair the Replacement Access in accordance with any requirements as the Director may impose from time to time.

(f) The Government will accept no responsibility or liability for any damage, nuisance or disturbance whatsoever caused to or suffered by the Purchaser by reason of the provision, maintenance and use of the Public Access or the Replacement Access, if any. The Purchaser shall indemnify and keep indemnified the Government from and against all liabilities, claims, costs, demands, actions or other proceedings whatsoever arising whether directly or indirectly out of or in connection with the provision and use and subsequent change, diversion or removal of the Public Access or the Replacement Access.

(g) It is hereby expressly agreed, declared and provided that by imposing the obligation on the part of the Purchaser contained in sub-clauses (b) and (e) of this Special Condition, neither the Purchaser intends to dedicate nor the Government consents to any dedication of the Public Access (including its replacement access under sub-clause (d) of this Special Condition) or any part or parts thereof to the public for the right of passage.

(h) It is expressly agreed and declared that the obligation on the part of the Purchaser contained in sub-clauses (b) and (e) of this Special Condition will give rise to no expectation of, or claim for or in respect of, any concession or right in respect of additional site coverage or plot ratio whether under Regulation 22 (1) of the Building (Planning) Regulations, any amendment thereto, substitution therefor, or otherwise and for the avoidance of doubt the Purchaser expressly waives any and all claims in respect of or for any concession in respect of, or right to, additional site coverage or plot ratio under Regulation 22(1) of the Building (Planning) Regulations, any amendment thereto or substitution therefor.”

#### G. Provisions of every deed of mutual covenant in respect of the specified residential property that concern those facilities and open spaces, and those parts of the land

Clause 1.1 of the DMC stipulates that:-

“1.1 In this Deed the following expressions shall have the following meanings except where the context otherwise permits or requires :-

...

“Development Common Areas and Facilities”  
means:-

(a) the Covered Landscaped and Play Areas, the Greenery Areas, the Owners’ Corporation Office, the Pink Hatched Brown Area, the Public Access, the Replacement Access, the Slope Structures, the Watchmen and Caretakers’ Room;

...

“Public Access”

means the Public Access as referred to in Special Condition No.(28)(b) of the Government Grant as shown coloured pink hatched green on the plan annexed to the Government Grant;



“Replacement Access”

means the Replacement Access as referred to in Special Condition No.(28)(d) of the Government Grant, which for the purposes of identification only are shown coloured Grey on the plans annexed hereto;

...”

Paragraphs 1(d) and 1(e) of Part B of the Second Schedule to the DMC stipulates that:-

“1. The following are the rights and privileges subject to which the Owner of each Undivided Share and the exclusive right to hold, use, occupy and enjoy his premises is held:-

...

(d) Until the completion of the Replacement Access, the free and unobstructed right of way of the Government and all members of the public at all times on foot or by wheelchair on, along, over, by and through the Public Access for ingress, egress and regress to and from the Graves and Licence Areas and Lai Ping Road;

(e) Upon completion of the Replacement Access, the free and unobstructed right of way of the Government and all members of the public at all times on foot or by wheelchair on, along, over, by and through the Replacement Access for ingress, egress and regress to and from the Graves and Licence Areas and Lai Ping Road;

...”

**A. 根據批地文件規定須興建並提供予政府或公眾使用的設施**

1. 描述

批地文件特別條件第(28)條中提及的「公共通道」及「代替通道」。

2. 公眾有權依據批地文件規定使用設施。

**B. 根據批地文件須由發展項目中的住宅物業的擁有人出資管理、營運或維修以作公眾使用的設施**

1. 描述

批地文件特別條件第(28)條中提及的「公共通道」及「代替通道」。

2. 公眾有權依據批地文件規定使用設施。

3. 設施由發展項目住宅物業的業主付費管理、營運或維修。

4. 發展項目住宅物業的業主應透過支付有關住宅物業應佔的管理開支，按比例分擔各設施的管理、營運或維修開支。

**C. 根據批地文件規定須由發展項目住宅物業的擁有人出資管理、營運或維持以供公眾使用的休憩用地**

不適用。

**D. 位於的土地（發展項目所在的土地）中為施行《建築物(規劃)條例》(香港法例第123章附屬法例F)第22(1)條而撥供公眾用途的任何部份：**

不適用。

**E. 顯示上述設施、休憩用地及該土地各部份的圖則**

請參閱本節末的圖則。

**F. 批地文件中關於該等設施、休憩用地及土地中該等部份的條文**

批地文件第(28)條批地特別條款訂明：

「(a) 買方承認目前在該地段毗鄰的政府土地上存在墳墓、構築物及寮屋，包括但不限於在本批地文件附錄的圖則上顯示並標明「LICENCE No. 7531」和「LICENCE No. Z0087」的位置上興建的許可構築物(以下統稱「墳墓及許可證區」)。

(b) 在本文件授予的整個租期期間，買方須自費准許政府和一切公眾人士享有道路權自由及暢通無阻地步行或推輪椅經過及再經過下列地方，在一切方面使署長滿意：

(i) 在本文件附錄的圖則上用粉紅色加綠斜線顯示該地段內的現有通道；及

(ii) 署長批准或要求該地段的其他部分

以便出入、經過及再經過本文件附錄的圖則上顯示並標明的墳墓及許可證區和麗坪路(本特別條款第(b)(i)分條提及的現有通道和署長按本特別條款第(b)(ii)分條批准或要求該地段的其他部分在下文統稱「公共通道」)。

(c) 買方須按署長可不時施加的任何要求自費鋪設、塑造、平整、保養、維護、維修及管理公共通道，在一切方

面使署長滿意。公共通道的定線須由署長不時書面決定。公共通道的闊度不能少於2.2米。

(d) 經署長的預先書面批准，買方可按署長施加的任何要求自費更改或代替在該地段內的公共通道，在一切方面使署長滿意(上述更改或代替的通道在下文稱為「代替通道」)。在完成代替通道之前，買方須按本特別條款第(a)分條規定在任何時候保持公共通道供政府和公眾自由及暢通無阻地使用。買方須就其沒有履行其職責或按本(d)分條進行任何工程直接或間接產生的一切責任、索償、費用、要求、訴訟、起訴、損害賠償或其他司法程序彌償及保障政府。

(e) 在完成代替通道後，買方須准許政府和公眾在任何時候為了一切合法目的免費及暢通無阻地步行或推輪椅經過及再經過代替通道，以便出入、經過及再經過墳墓及許可證區和麗坪路。買方須按署長可不時施加的任何要求自費管理、保養、維護及維修代替通道，在一切方面使署長滿意。

(f) 政府毋須對提供、保養及使用公共通道或代替通道造成買方蒙受任何損害、滋擾、干擾(如有)承擔任何責任或義務。買方須就提供、使用和其後改變、分道或移走公共通道或代替通道直接或間接產生的一切責任、索償、費用、要求、訴訟或其他司法程序彌償及保障政府。

(g) 特此明文同意、聲明及規定，就買方承擔本特別條款第(b)和(c)分條的責任，買方並非擬奉獻，而政府亦不是同意奉獻公共通道(包括本特別條款第(d)分條下的代替通道)或其中任何部分給公眾通行的權利。

(h) 特此明文同意及聲明，買方承擔本特別條款第(b)和(c)分條提及的責任，並非期望或要求根據《建築物(規劃)規例》第22(1)條及其任何修訂或代替條例規定享有額外上蓋面積或地積比的任何優惠或權利。為免存疑，買方現明確放棄基於或鑒於《建築物(規劃)規例》第22(1)條規例或其任何修訂或取代條文等所訂額外上蓋面積或地積比率特許或權利提出任何及所有索償。」

**G. 指明住宅物業的每一公契中關於該等設施、休憩用地及土地中的該等部份的條文**

公契第1.1條訂明：

「1.1 在本公契中，除非上下文義另有准許或要求，下列詞語具有以下界定的意義：

...

「發展項目公用地方及設施」

指：-

(a) 有蓋園藝及遊樂區、綠化區、業主立案法團辦事處、粉紅色加棕斜線範圍、公共通道、替代通道、斜坡構築物、看更及管理員室；

...

「公共通道」

指政府批地書特別條件第(28)(b)條提述的公共通道，在政府批地書附錄的圖則上用粉紅色加綠斜線顯示；



**INFORMATION ON PUBLIC FACILITIES AND PUBLIC OPEN SPACES**

**公共設施及公眾休憩用地的資料**

「代替通道」

指政府批地書特別條件第(28)(d)條提述的替代通道，在本公契附錄的圖則上用灰色顯示，僅供識別；

…」

公契附件二B部份第1(d)及1(e)段訂明：

「1. 持有每份不分割份數和有權獨家持有、使用、佔用和享用連帶持有他的房產的業主須受制於下列權利及特權：

…

(d) 完成替代通道之前，政府和一切公眾人士有道路權在任何時候自由及不受阻礙地步行或推輪椅經過及再經過公共通道，以便出入、經過及再經過墳墓及許可證區和麗坪路；

(e) 完成替代通道之後，政府和一切公眾人士有道路權在任何時候自由及不受阻礙地步行或推輪椅經過及再經過替代通道，以便出入、經過及再經過墳墓及許可證區和麗坪路；

…」

Extracted from PLAN annexed to New Grant No. 21670

摘錄自新批地規約第 21670 號夾附的圖則

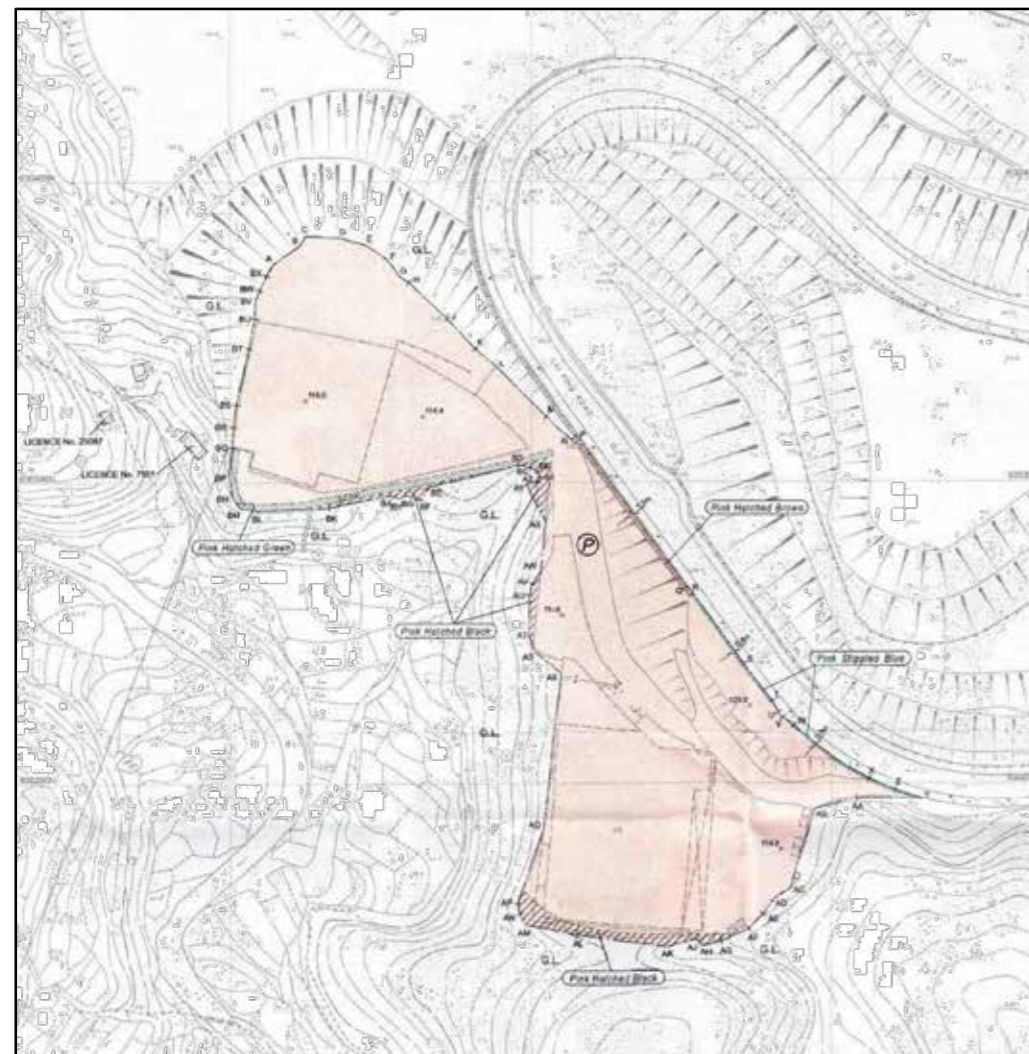

Plan showing the location of the Replacement Access

顯示代替通道位置的圖則

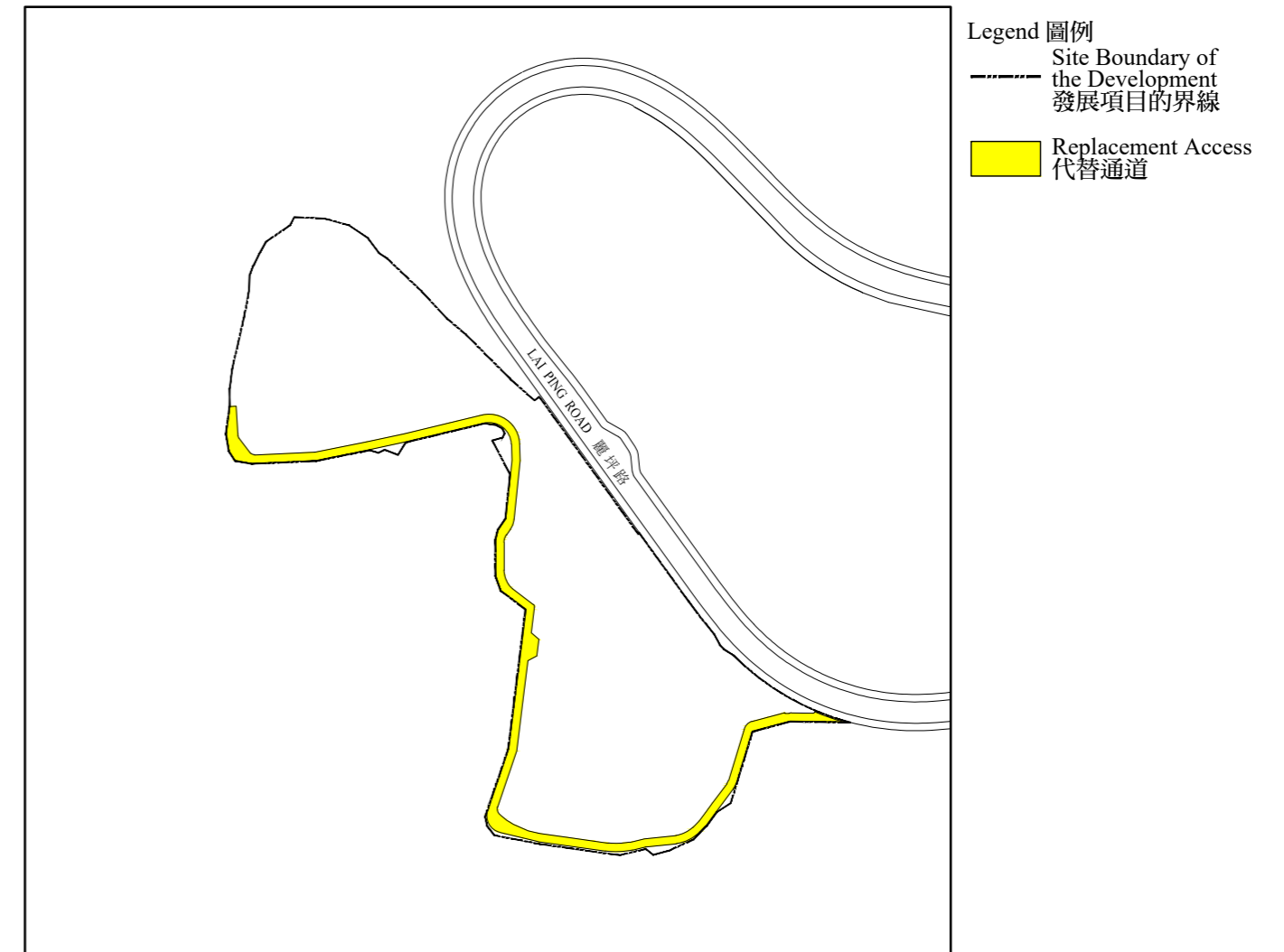

## WARNING TO PURCHASERS

### 對買方的警告

- (a) The purchaser is recommended to instruct a separate firm of solicitors (other than that acting for the owner) to act for the purchaser in relation to the transaction.
  - (b) If the purchaser instructs such separate firm of solicitors to act for the purchaser in relation to the transaction, that firm will be able to give independent advice to the purchaser.
  - (c) If the purchaser instructs the firm of solicitors acting for the owner to act for the purchaser as well, and if a conflict of interest arises between the owner and the purchaser,
    - (i) that firm may not be able to protect the purchaser's interests; and
    - (ii) the purchaser may have to instruct a separate firm of solicitors; and
    - (iii) in the case of paragraph (c)(ii), the total solicitors' fees payable by the purchaser may be higher than the fees that would have been payable if the purchaser had instructed a separate firm of solicitors in the first place.
- (a) 現建議買方聘用一間獨立的律師事務所(代表擁有人行事者除外)，以在交易中代表買方行事。
  - (b) 如買方聘用上述的獨立的律師事務所，以在交易中代表買方行事，該律師事務所將會能夠向買方提供獨立意見。
  - (c) 如買方聘用代表擁有人行事的律師事務所同時代表買方行事，而擁有人與買方之間出現利益衝突—
    - (i) 該律師事務所可能不能夠保障買方的利益；及
    - (ii) 買方可能要聘用一間獨立的律師事務所；及
    - (iii) 如屬(c)(ii)段的情況，買方須支付的律師費用總數，可能高於如買方自一開始即聘用一間獨立的律師事務所須支付的費用。

CROSS-SECTION PLAN OF BUILDING IN THE DEVELOPMENT  
發展項目中的建築物的橫截面圖

Key Plan  
索引圖

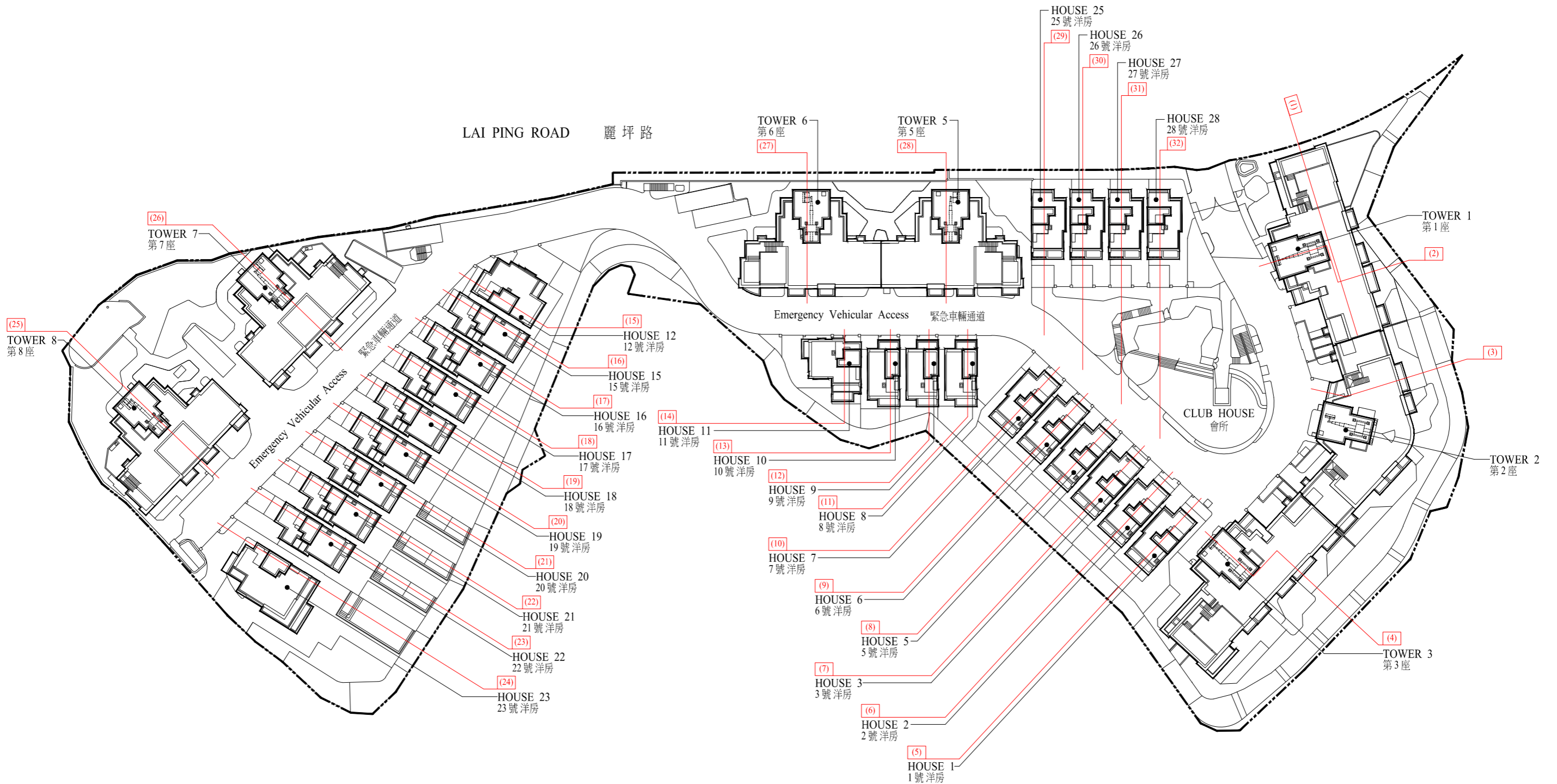
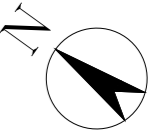

Scale: 0M/米 30M/米  
比例: 0 30

# CROSS-SECTION PLAN OF BUILDING IN THE DEVELOPMENT

## 發展項目中的建築物的橫截面圖

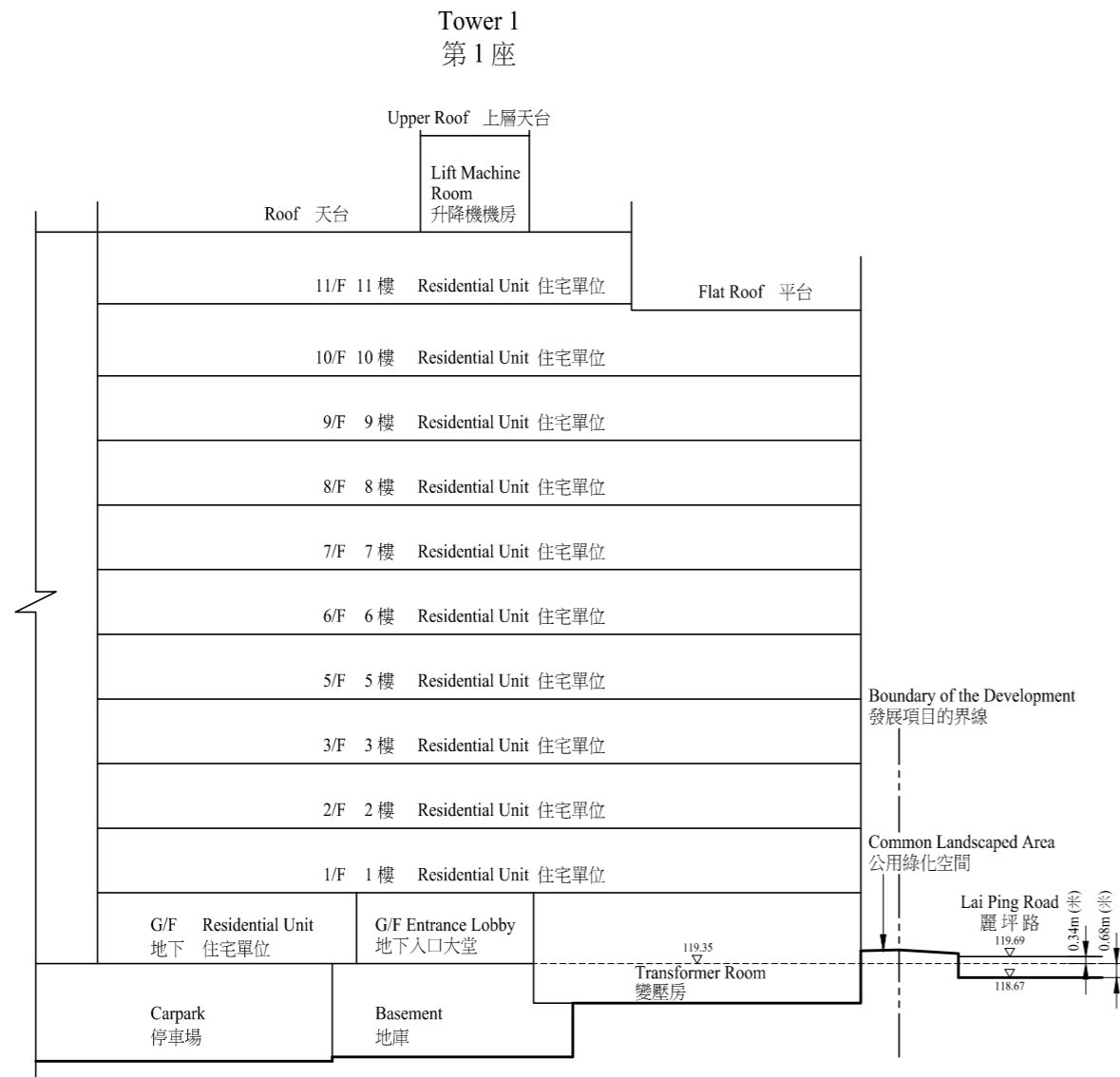

Cross-section Plan (1)  
橫截面圖 (1)

The part of Lai Ping Road adjacent to the building is 118.67 to 119.69 metres above the Hong Kong Principal Datum.  
毗連建築物的一段麗坪路為香港主水平基準以上 118.67 至 119.69 米。

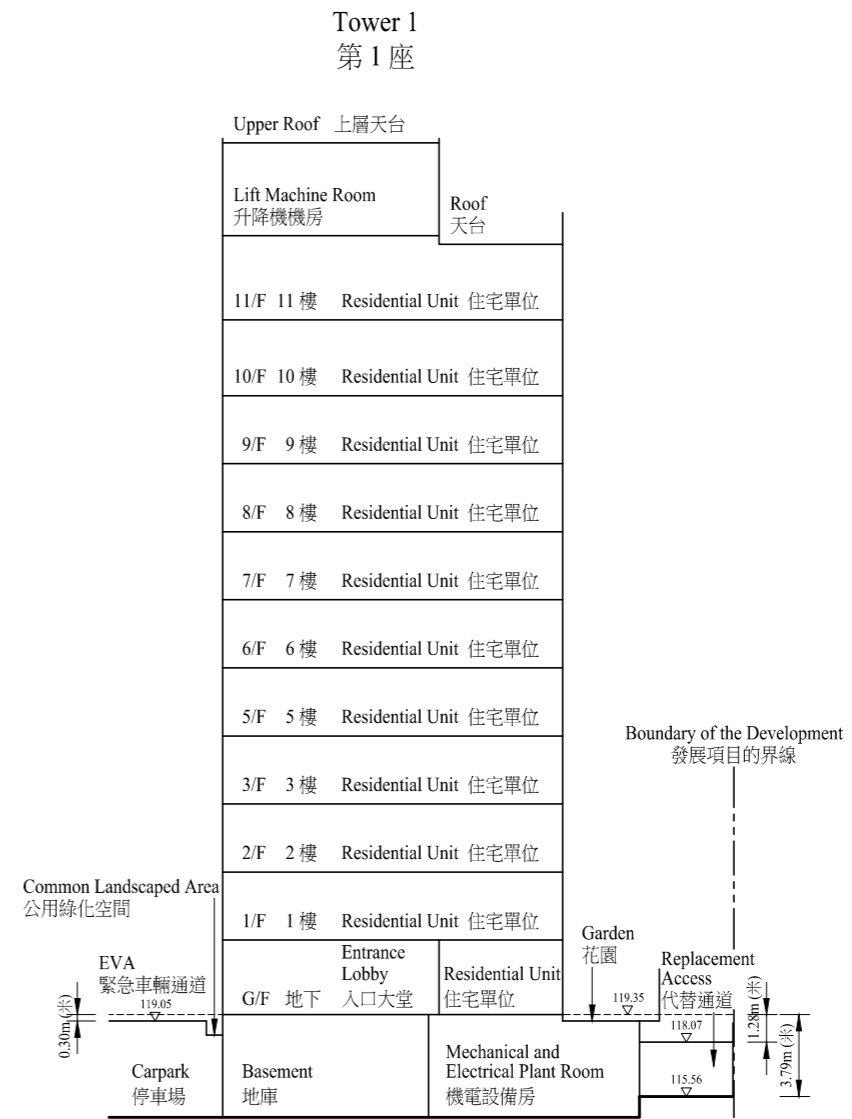

Cross-section Plan (2)  
橫截面圖 (2)

The part of Replacement Access adjacent to the building is 115.56 to 118.07 metres above the Hong Kong Principal Datum.  
毗連建築物的一段代替通道為香港主水平基準以上 115.56 至 118.07 米。

The part of Emergency Vehicular Access (EVA) adjacent to the building is 119.05 metres above the Hong Kong Principal Datum.  
毗連建築物的一段緊急車輛通道為香港主水平基準以上 119.05 米。

-----Dotted line denotes the lowest residential floor.  
虛線為最低住宅樓層水平。

▽ Denotes height (in metres) above the Hong Kong Principal Datum.  
代表香港主水平基準以上的高度(米)。



# CROSS-SECTION PLAN OF BUILDING IN THE DEVELOPMENT 發展項目中的建築物的橫截面圖

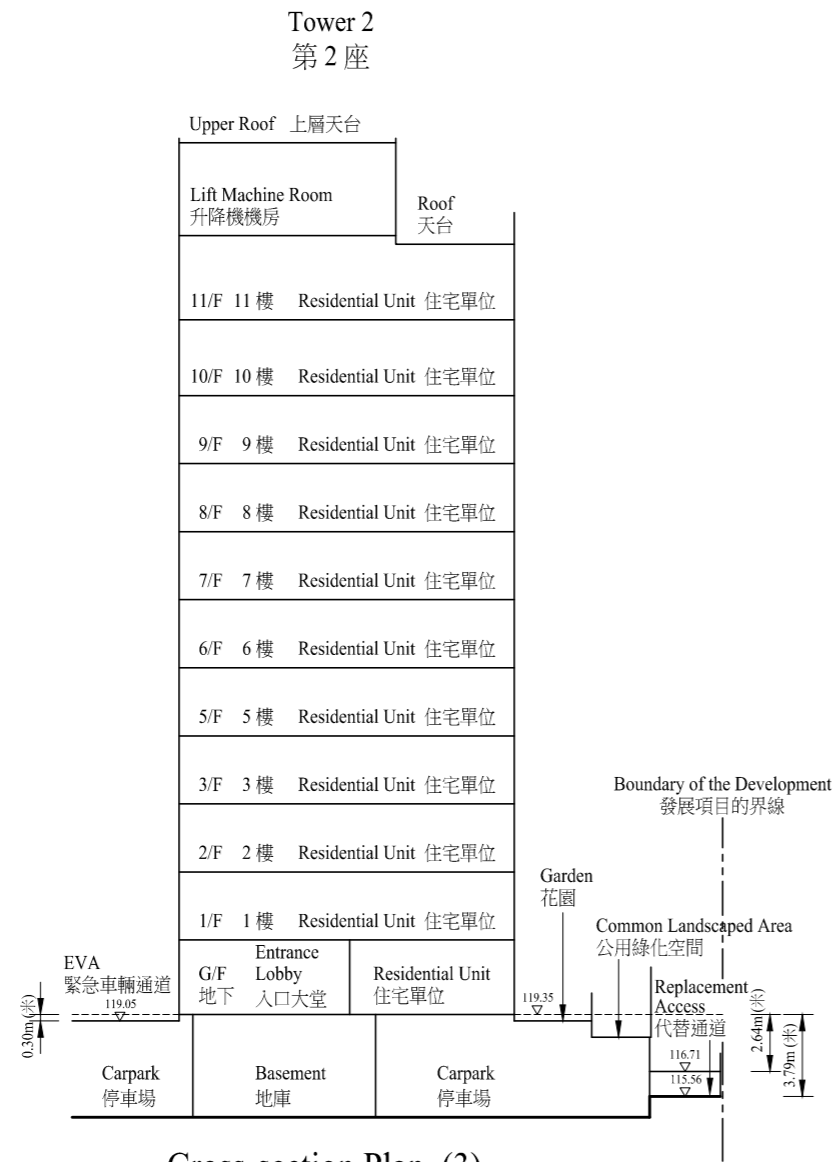

Cross-section Plan (3)  
橫截面圖 (3)

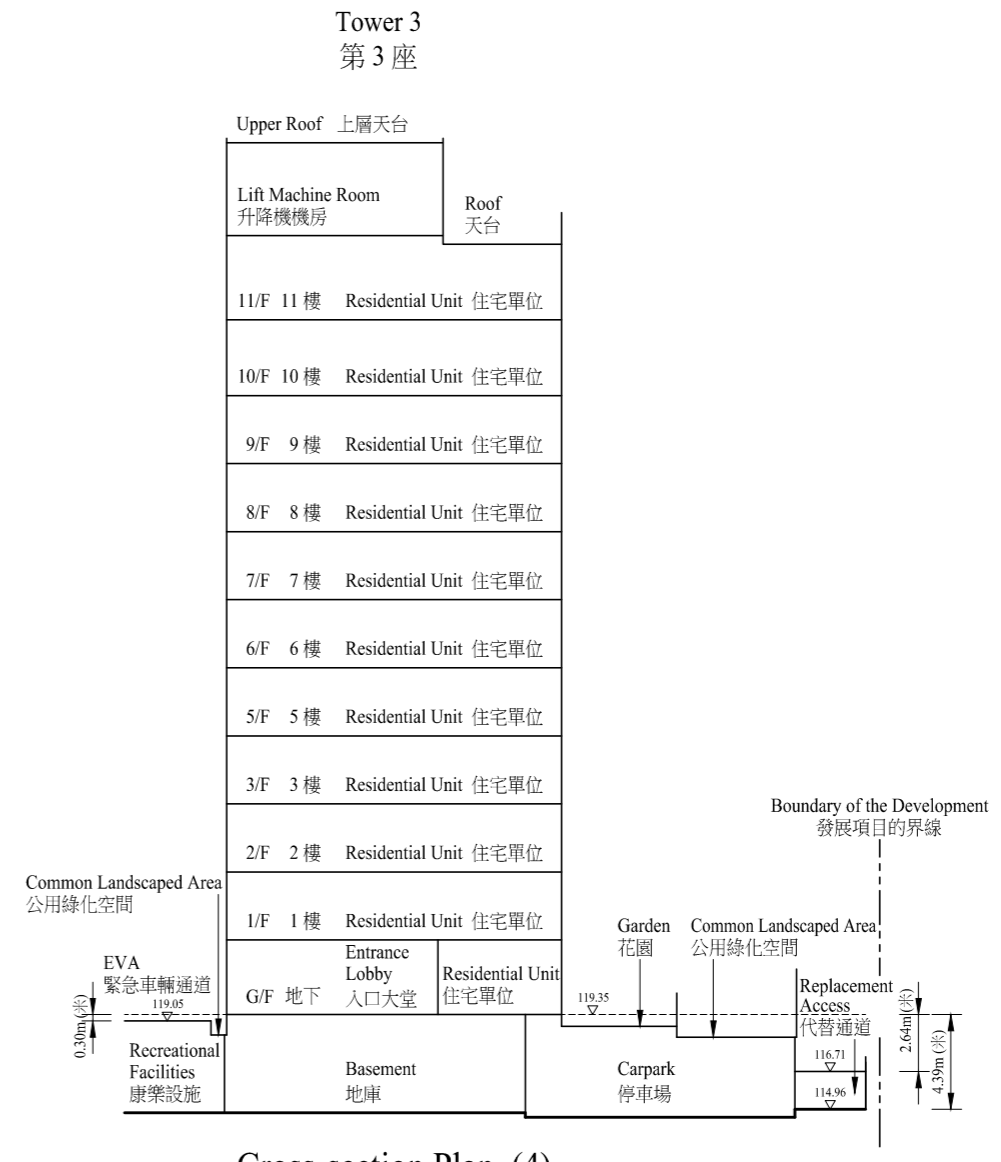

Cross-section Plan (4)  
橫截面圖 (4)

The part of Replacement Access adjacent to the building is 115.56 to 116.71 metres above the Hong Kong Principal Datum.  
毗連建築物的一段代替通道為香港主水平基準以上 115.56 至 116.71 米。

The part of Emergency Vehicular Access (EVA) adjacent to the building is 119.05 metres above the Hong Kong Principal Datum.  
毗連建築物的一段緊急車輛通道為香港主水平基準以上 119.05 米。

The part of Replacement Access adjacent to the building is 114.96 to 116.71 metres above the Hong Kong Principal Datum.  
毗連建築物的一段代替通道為香港主水平基準以上 114.96 至 116.71 米。

The part of Emergency Vehicular Access (EVA) adjacent to the building is 119.05 metres above the Hong Kong Principal Datum.  
毗連建築物的一段緊急車輛通道為香港主水平基準以上 119.05 米。

-----Dotted line denotes the lowest residential floor.  
虛線為最低住宅樓層水平。

▽ Denotes height (in metres) above the Hong Kong Principal Datum.  
代表香港主水平基準以上的高度(米)。



# CROSS-SECTION PLAN OF BUILDING IN THE DEVELOPMENT

## 發展項目中的建築物的橫截面圖

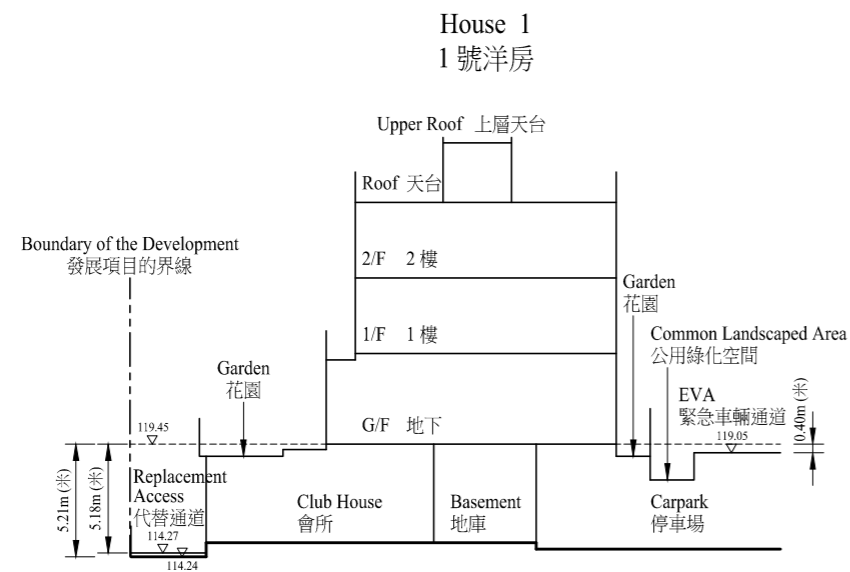

Cross-section Plan (5)  
橫截面圖 (5)

The part of Replacement Access adjacent to the building is 114.24 to 114.27 metres above the Hong Kong Principal Datum.  
毗連建築物的一段代替通道為香港主水平基準以上 114.24 至 114.27 米。

The part of Emergency Vehicular Access (EVA) adjacent to the building is 119.05 metres above the Hong Kong Principal Datum.  
毗連建築物的一段緊急車輛通道為香港主水平基準以上 119.05 米。

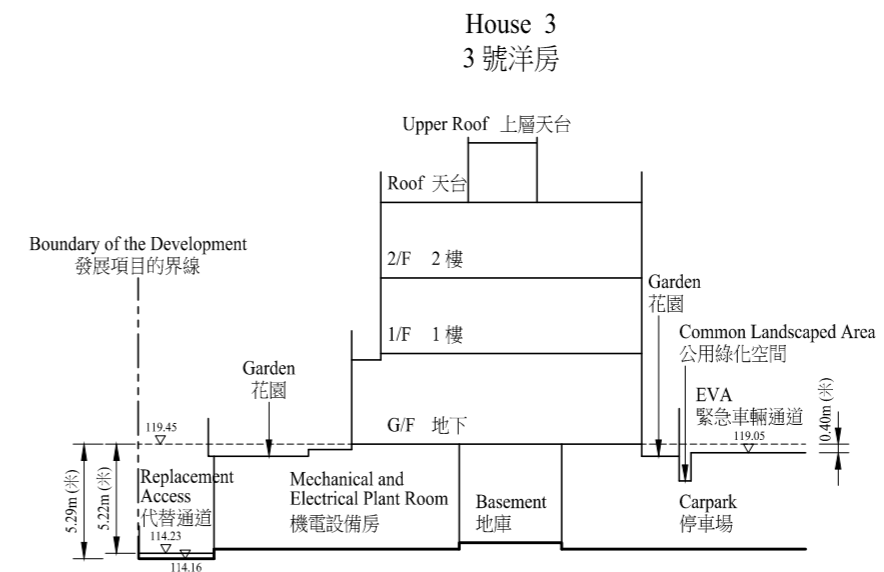

Cross-section Plan (7)  
橫截面圖 (7)

The part of Replacement Access adjacent to the building is 114.16 to 114.23 metres above the Hong Kong Principal Datum.  
毗連建築物的一段代替通道為香港主水平基準以上 114.16 至 114.23 米。

The part of Emergency Vehicular Access (EVA) adjacent to the building is 119.05 metres above the Hong Kong Principal Datum.  
毗連建築物的一段緊急車輛通道為香港主水平基準以上 119.05 米。

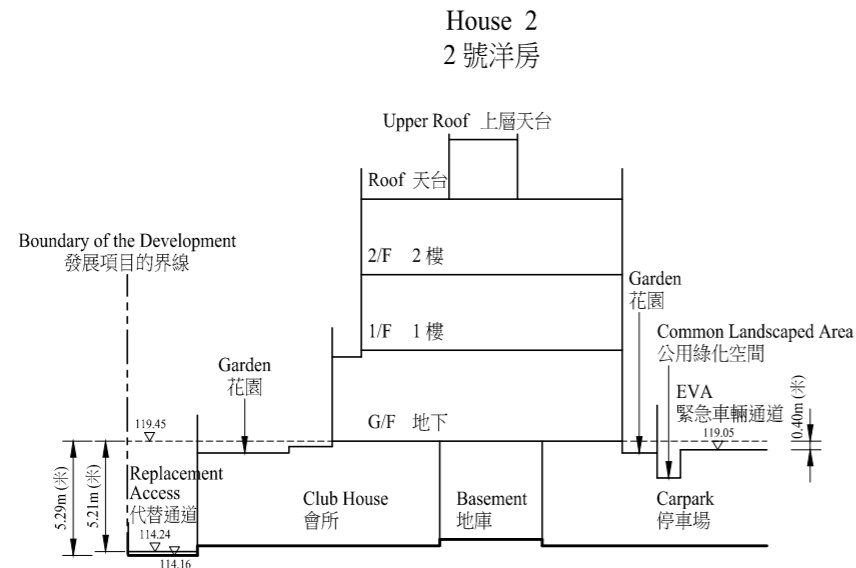

Cross-section Plan (6)  
橫截面圖 (6)

The part of Replacement Access adjacent to the building is 114.16 to 114.24 metres above the Hong Kong Principal Datum.  
毗連建築物的一段代替通道為香港主水平基準以上 114.16 至 114.24 米。

The part of Emergency Vehicular Access (EVA) adjacent to the building is 119.05 metres above the Hong Kong Principal Datum.  
毗連建築物的一段緊急車輛通道為香港主水平基準以上 119.05 米。

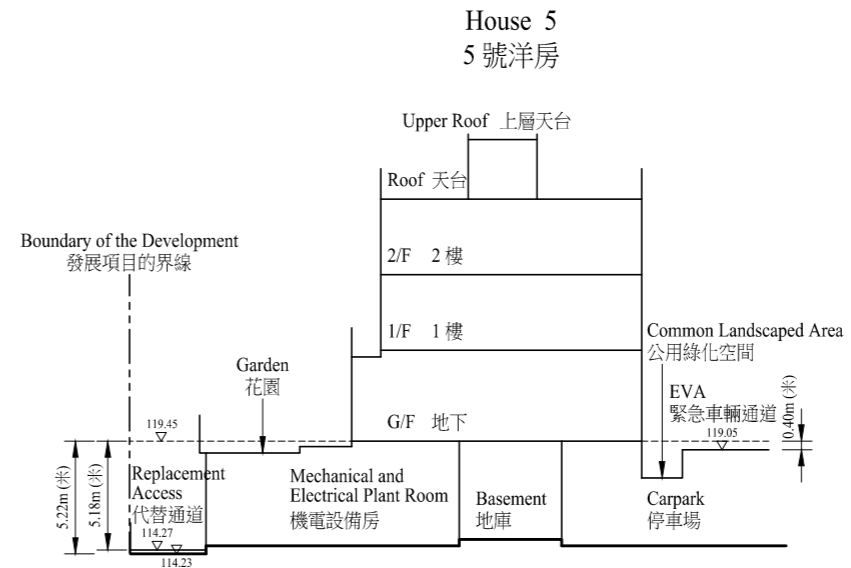

Cross-section Plan (8)  
橫截面圖 (8)

The part of Replacement Access adjacent to the building is 114.23 to 114.27 metres above the Hong Kong Principal Datum.  
毗連建築物的一段代替通道為香港主水平基準以上 114.23 至 114.27 米。

The part of Emergency Vehicular Access (EVA) adjacent to the building is 119.05 metres above the Hong Kong Principal Datum.  
毗連建築物的一段緊急車輛通道為香港主水平基準以上 119.05 米。

-----Dotted line denotes the lowest residential floor.  
虛線為最低住宅樓層水平。

▽ Denotes height (in metres) above the Hong Kong Principal Datum.  
代表香港主水平基準以上的高度(米)。

# CROSS-SECTION PLAN OF BUILDING IN THE DEVELOPMENT

## 發展項目中的建築物的橫截面圖

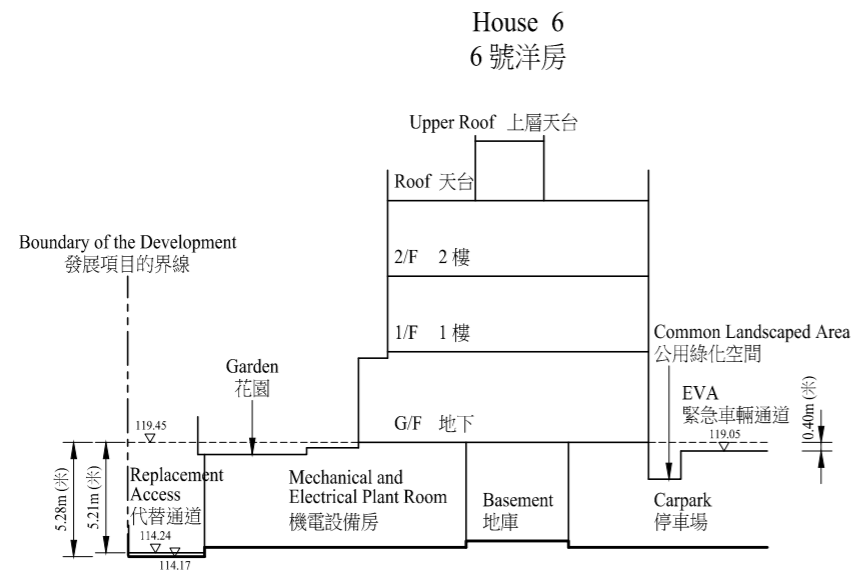

Cross-section Plan (9)  
橫截面圖 (9)

The part of Replacement Access adjacent to the building is 114.17 to 114.24 metres above the Hong Kong Principal Datum.  
毗連建築物的一段代替通道為香港主水平基準以上 114.17 至 114.24 米。

The part of Emergency Vehicular Access (EVA) adjacent to the building is 119.05 metres above the Hong Kong Principal Datum.  
毗連建築物的一段緊急車輛通道為香港主水平基準以上 119.05 米。

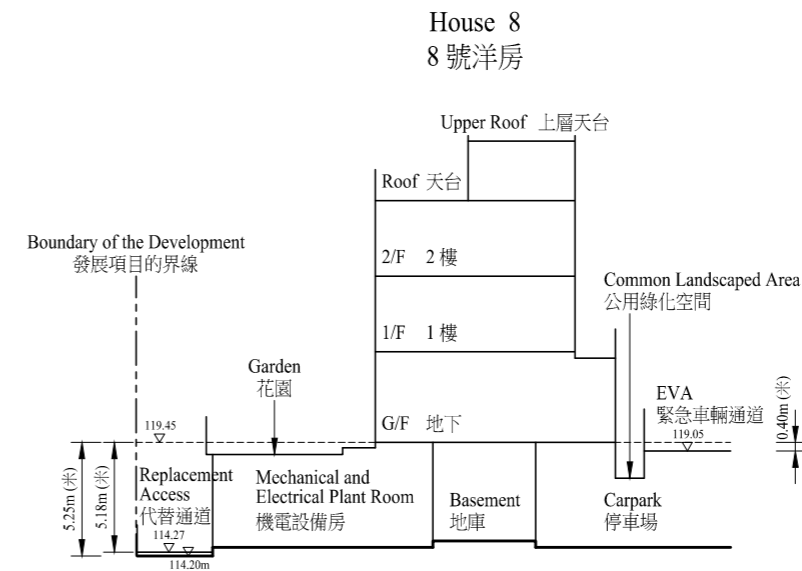

Cross-section Plan (11)  
橫截面圖 (11)

The part of Replacement Access adjacent to the building is 114.20 to 114.27 metres above the Hong Kong Principal Datum.  
毗連建築物的一段代替通道為香港主水平基準以上 114.20 至 114.27 米。

The part of Emergency Vehicular Access (EVA) adjacent to the building is 119.05 metres above the Hong Kong Principal Datum.  
毗連建築物的一段緊急車輛通道為香港主水平基準以上 119.05 米。

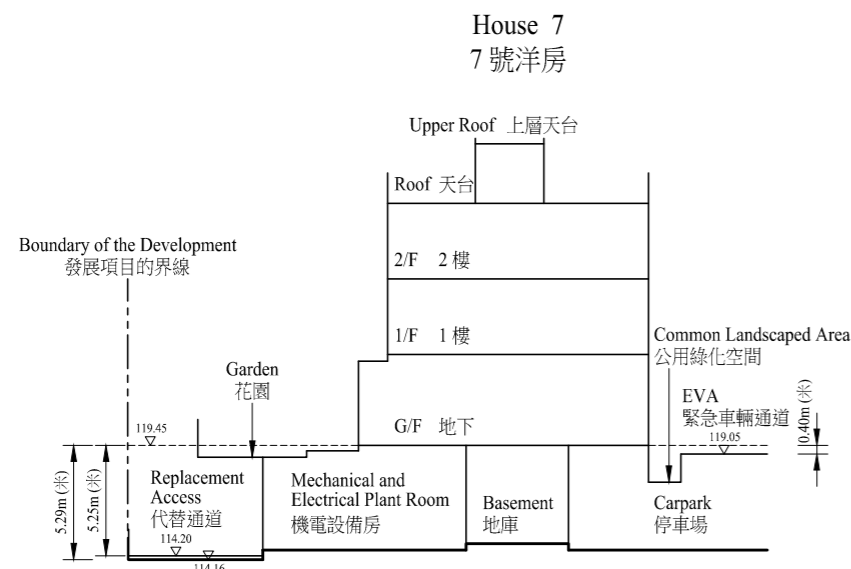

Cross-section Plan (10)  
橫截面圖 (10)

The part of Replacement Access adjacent to the building is 114.16 to 114.20 metres above the Hong Kong Principal Datum.  
毗連建築物的一段代替通道為香港主水平基準以上 114.16 至 114.20 米。

The part of Emergency Vehicular Access (EVA) adjacent to the building is 119.05 metres above the Hong Kong Principal Datum.  
毗連建築物的一段緊急車輛通道為香港主水平基準以上 119.05 米。

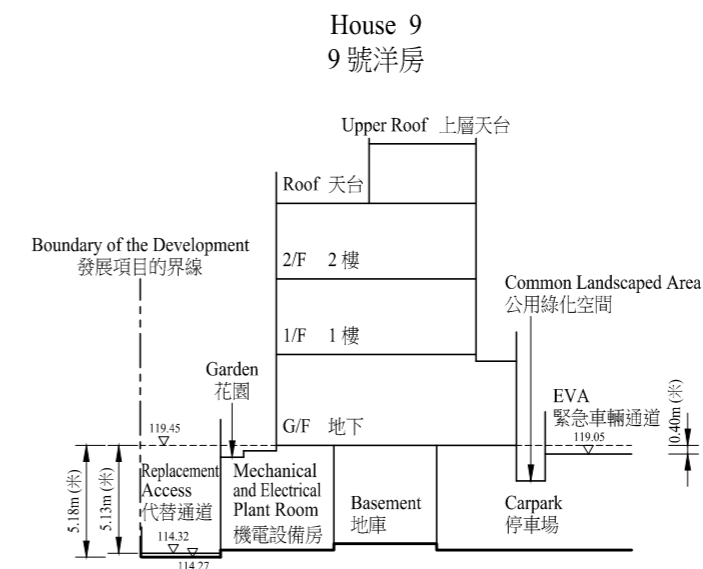

Cross-section Plan (12)  
橫截面圖 (12)

The part of Replacement Access adjacent to the building is 114.27 to 114.32 metres above the Hong Kong Principal Datum.  
毗連建築物的一段代替通道為香港主水平基準以上 114.27 至 114.32 米。

The part of Emergency Vehicular Access (EVA) adjacent to the building is 119.05 metres above the Hong Kong Principal Datum.  
毗連建築物的一段緊急車輛通道為香港主水平基準以上 119.05 米。

-----Dotted line denotes the lowest residential floor.  
虛線為最低住宅樓層水平。

▽ Denotes height (in metres) above the Hong Kong Principal Datum.  
代表香港主水平基準以上的高度(米)。

# CROSS-SECTION PLAN OF BUILDING IN THE DEVELOPMENT

## 發展項目中的建築物的橫截面圖

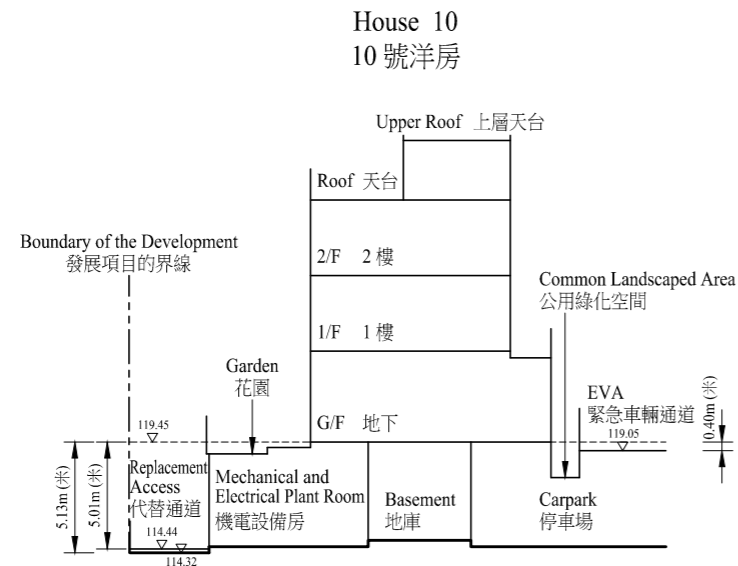

Cross-section Plan (13)  
橫截面圖 (13)

The part of Replacement Access adjacent to the building is 114.32 to 114.44 metres above the Hong Kong Principal Datum.  
毗連建築物的一段代替通道為香港主水平基準以上 114.32 至 114.44 米。

The part of Emergency Vehicular Access (EVA) adjacent to the building is 119.05 metres above the Hong Kong Principal Datum.  
毗連建築物的一段緊急車輛通道為香港主水平基準以上 119.05 米。

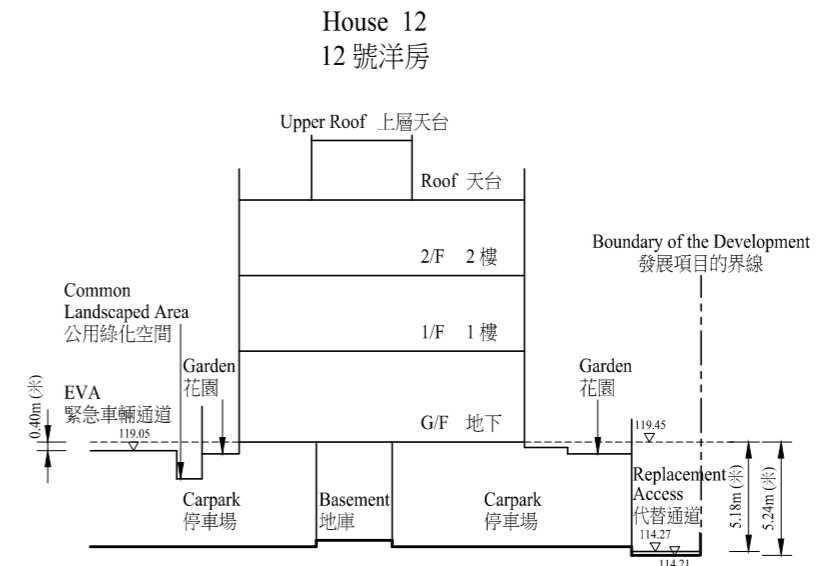

Cross-section Plan (15)  
橫截面圖 (15)

The part of Replacement Access adjacent to the building is 114.21 to 114.27 metres above the Hong Kong Principal Datum.  
毗連建築物的一段代替通道為香港主水平基準以上 114.21 至 114.27 米。

The part of Emergency Vehicular Access (EVA) adjacent to the building is 119.05 metres above the Hong Kong Principal Datum.  
毗連建築物的一段緊急車輛通道為香港主水平基準以上 119.05 米。

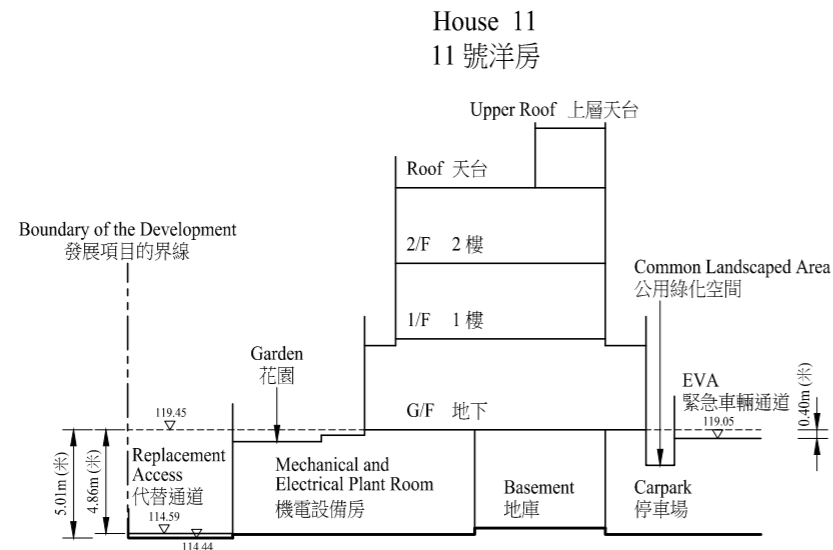

Cross-section Plan (14)  
橫截面圖 (14)

The part of Replacement Access adjacent to the building is 114.44 to 114.59 metres above the Hong Kong Principal Datum.  
毗連建築物的一段代替通道為香港主水平基準以上 114.44 至 114.59 米。

The part of Emergency Vehicular Access (EVA) adjacent to the building is 119.05 metres above the Hong Kong Principal Datum.  
毗連建築物的一段緊急車輛通道為香港主水平基準以上 119.05 米。

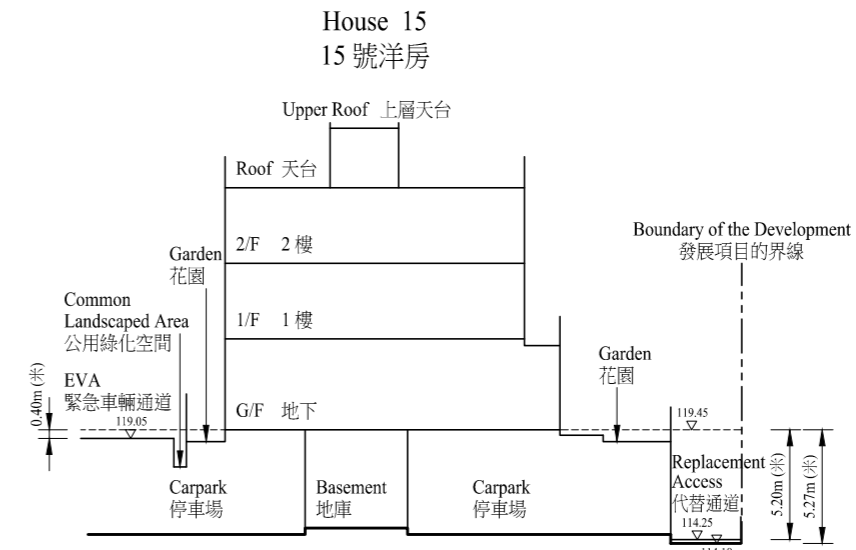

Cross-section Plan (16)  
橫截面圖 (16)

The part of Replacement Access adjacent to the building is 114.18 to 114.25 metres above the Hong Kong Principal Datum.  
毗連建築物的一段代替通道為香港主水平基準以上 114.18 至 114.25 米。

The part of Emergency Vehicular Access (EVA) adjacent to the building is 119.05 metres above the Hong Kong Principal Datum.  
毗連建築物的一段緊急車輛通道為香港主水平基準以上 119.05 米。

-----Dotted line denotes the lowest residential floor.  
虛線為最低住宅樓層水平。

▽ Denotes height (in metres) above the Hong Kong Principal Datum.  
代表香港主水平基準以上的高度(米)。

# CROSS-SECTION PLAN OF BUILDING IN THE DEVELOPMENT

## 發展項目中的建築物的橫截面圖

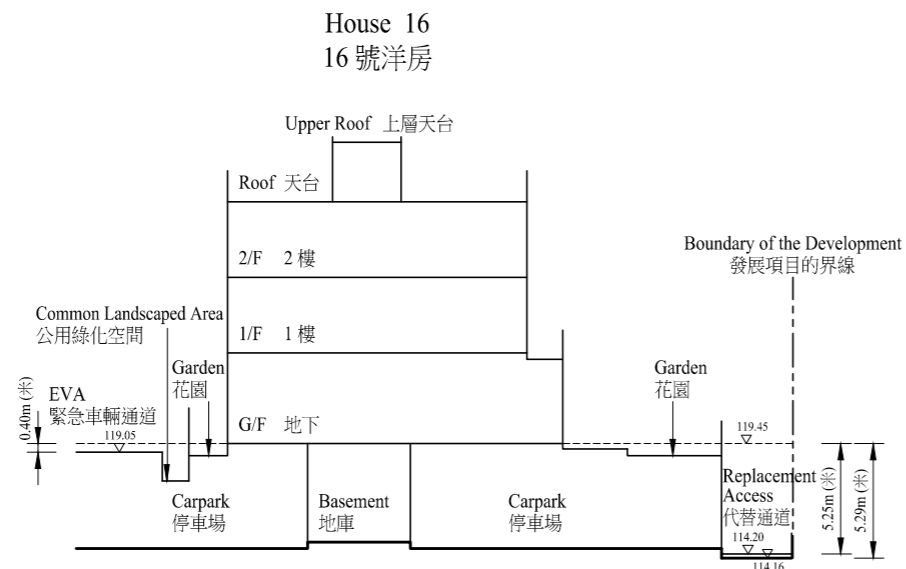

Cross-section Plan (17)  
橫截面圖 (17)

The part of Replacement Access adjacent to the building is 114.16 to 114.20 metres above the Hong Kong Principal Datum.  
毗連建築物的一段代替通道為香港主水平基準以上 114.16 至 114.20 米。

The part of Emergency Vehicular Access (EVA) adjacent to the building is 119.05 metres above the Hong Kong Principal Datum.  
毗連建築物的一段緊急車輛通道為香港主水平基準以上 119.05 米。

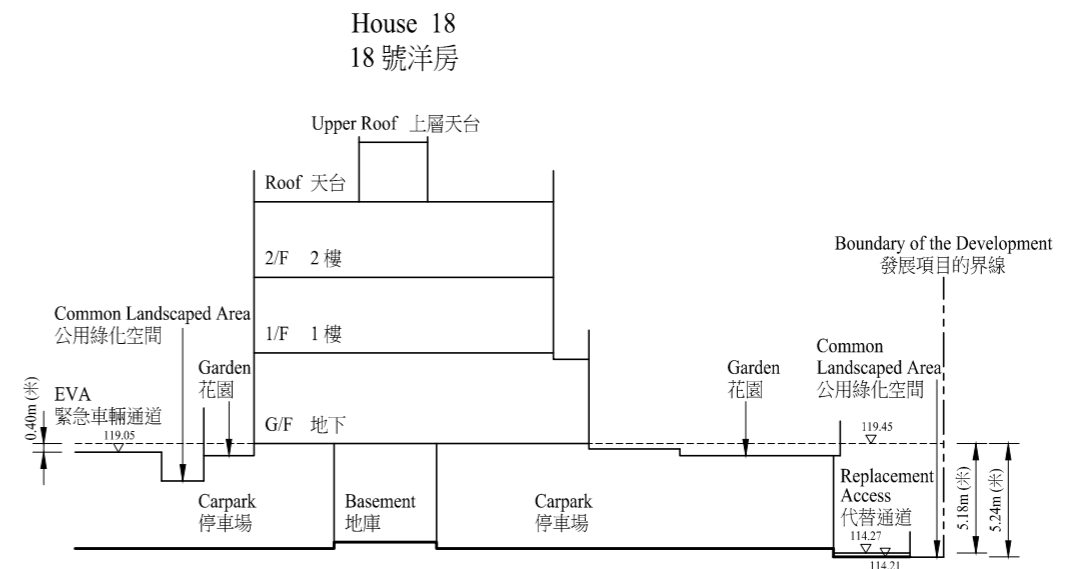

Cross-section Plan (19)  
橫截面圖 (19)

The part of Replacement Access adjacent to the building is 114.21 to 114.27 metres above the Hong Kong Principal Datum.  
毗連建築物的一段代替通道為香港主水平基準以上 114.21 至 114.27 米。

The part of Emergency Vehicular Access (EVA) adjacent to the building is 119.05 metres above the Hong Kong Principal Datum.  
毗連建築物的一段緊急車輛通道為香港主水平基準以上 119.05 米。

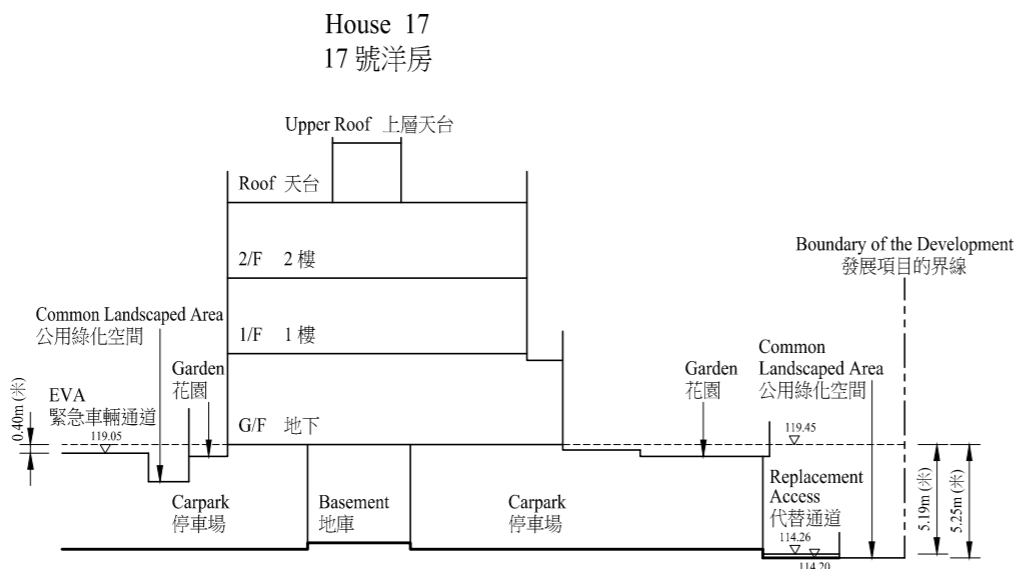

Cross-section Plan (18)  
橫截面圖 (18)

The part of Replacement Access adjacent to the building is 114.20 to 114.26 metres above the Hong Kong Principal Datum.  
毗連建築物的一段代替通道為香港主水平基準以上 114.20 至 114.26 米。

The part of Emergency Vehicular Access (EVA) adjacent to the building is 119.05 metres above the Hong Kong Principal Datum.  
毗連建築物的一段緊急車輛通道為香港主水平基準以上 119.05 米。

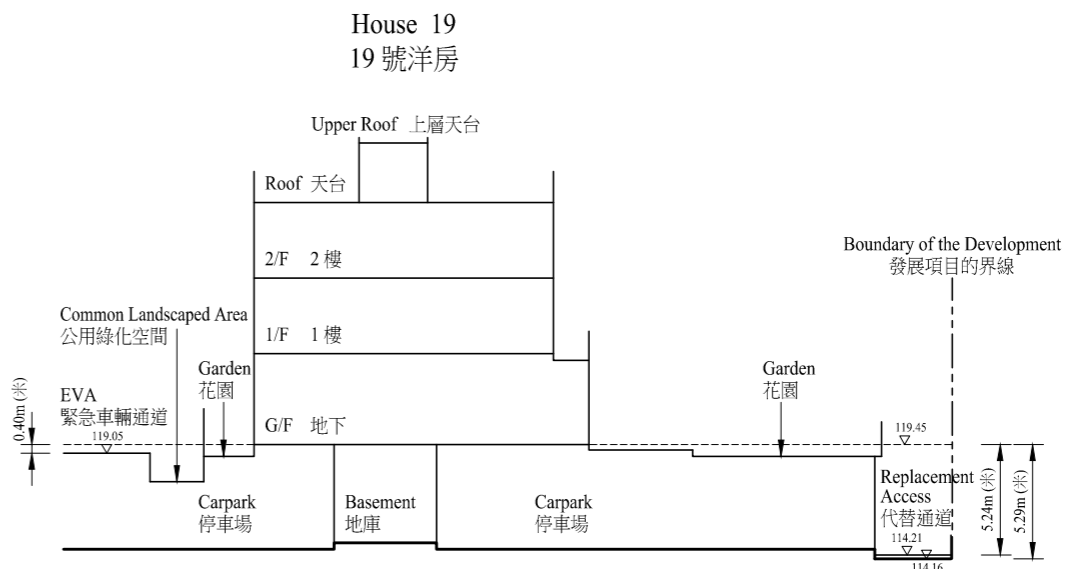

Cross-section Plan (20)  
橫截面圖 (20)

The part of Replacement Access adjacent to the building is 114.16 to 114.21 metres above the Hong Kong Principal Datum.  
毗連建築物的一段代替通道為香港主水平基準以上 114.16 至 114.21 米。

The part of Emergency Vehicular Access (EVA) adjacent to the building is 119.05 metres above the Hong Kong Principal Datum.  
毗連建築物的一段緊急車輛通道為香港主水平基準以上 119.05 米。

-----Dotted line denotes the lowest residential floor.  
虛線為最低住宅樓層水平。

▽ Denotes height (in metres) above the Hong Kong Principal Datum.  
代表香港主水平基準以上的高度(米)。

# CROSS-SECTION PLAN OF BUILDING IN THE DEVELOPMENT

## 發展項目中的建築物的橫截面圖

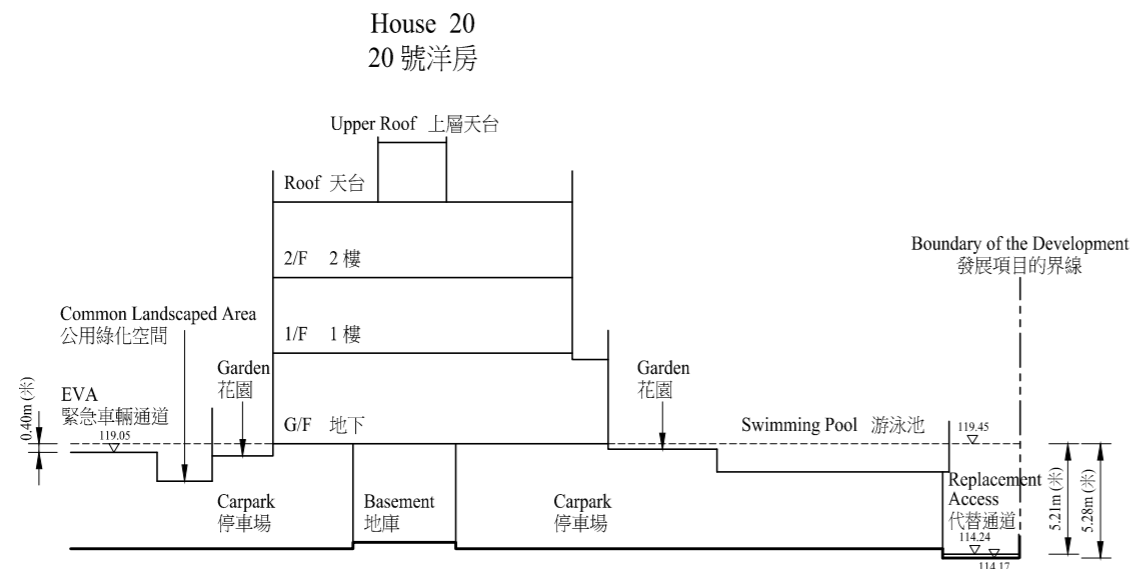

Cross-section Plan (21)  
橫截面圖 (21)

The part of Replacement Access adjacent to the building is 114.17 to 114.24 metres above the Hong Kong Principal Datum.  
毗連建築物的一段代替通道為香港主水平基準以上 114.17 至 114.24 米。

The part of Emergency Vehicular Access (EVA) adjacent to the building is 119.05 metres above the Hong Kong Principal Datum.  
毗連建築物的一段緊急車輛通道為香港主水平基準以上 119.05 米。

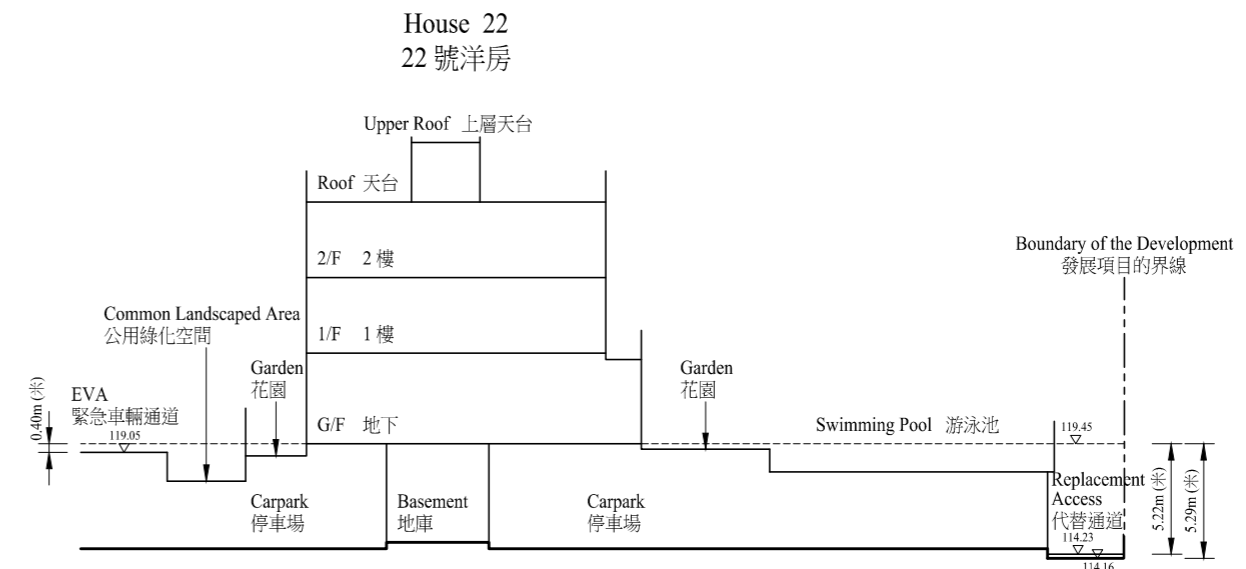

Cross-section Plan (23)  
橫截面圖 (23)

The part of Replacement Access adjacent to the building is 114.16 to 114.23 metres above the Hong Kong Principal Datum.  
毗連建築物的一段代替通道為香港主水平基準以上 114.16 至 114.23 米。

The part of Emergency Vehicular Access (EVA) adjacent to the building is 119.05 metres above the Hong Kong Principal Datum.  
毗連建築物的一段緊急車輛通道為香港主水平基準以上 119.05 米。

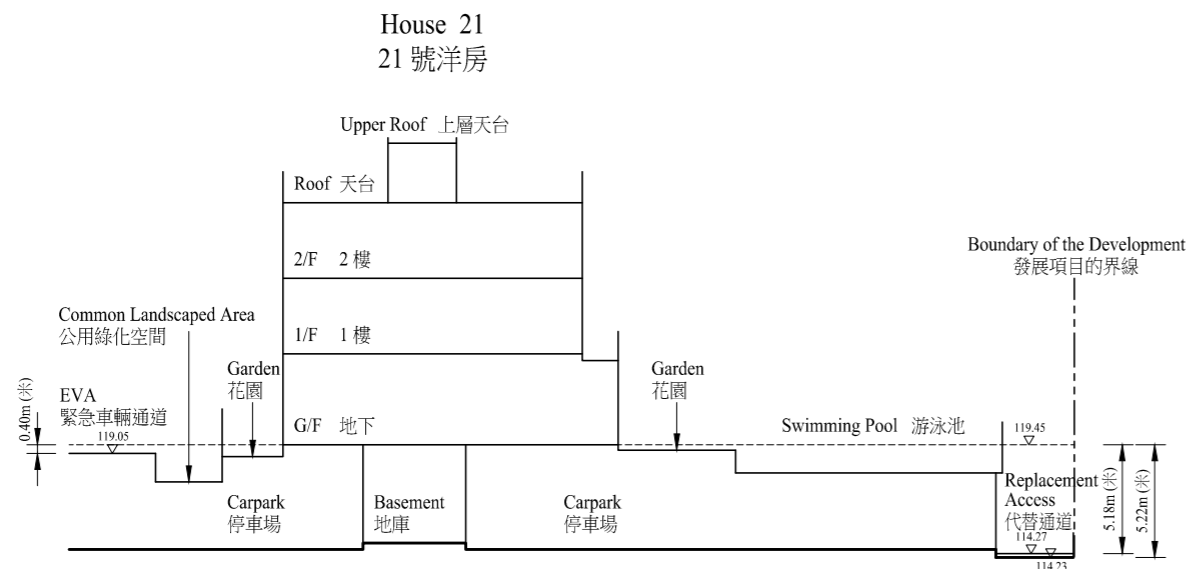

Cross-section Plan (22)  
橫截面圖 (22)

The part of Replacement Access adjacent to the building is 114.23 to 114.27 metres above the Hong Kong Principal Datum.  
毗連建築物的一段代替通道為香港主水平基準以上 114.23 至 114.27 米。

The part of Emergency Vehicular Access (EVA) adjacent to the building is 119.05 metres above the Hong Kong Principal Datum.  
毗連建築物的一段緊急車輛通道為香港主水平基準以上 119.05 米。

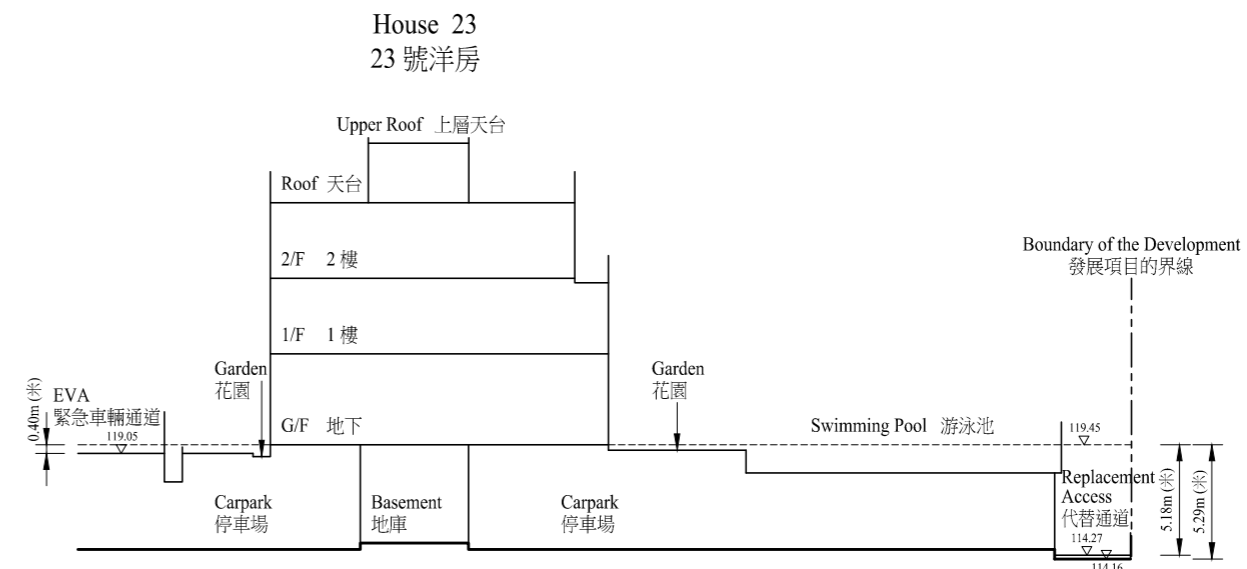

Cross-section Plan (24)  
橫截面圖 (24)

The part of Replacement Access adjacent to the building is 114.16 to 114.27 metres above the Hong Kong Principal Datum.  
毗連建築物的一段代替通道為香港主水平基準以上 114.16 至 114.27 米。

The part of Emergency Vehicular Access (EVA) adjacent to the building is 119.05 metres above the Hong Kong Principal Datum.  
毗連建築物的一段緊急車輛通道為香港主水平基準以上 119.05 米。

-----Dotted line denotes the lowest residential floor.  
虛線為最低住宅樓層水平。

▽ Denotes height (in metres) above the Hong Kong Principal Datum.  
代表香港主水平基準以上的高度(米)。



# CROSS-SECTION PLAN OF BUILDING IN THE DEVELOPMENT 發展項目中的建築物的橫截面圖

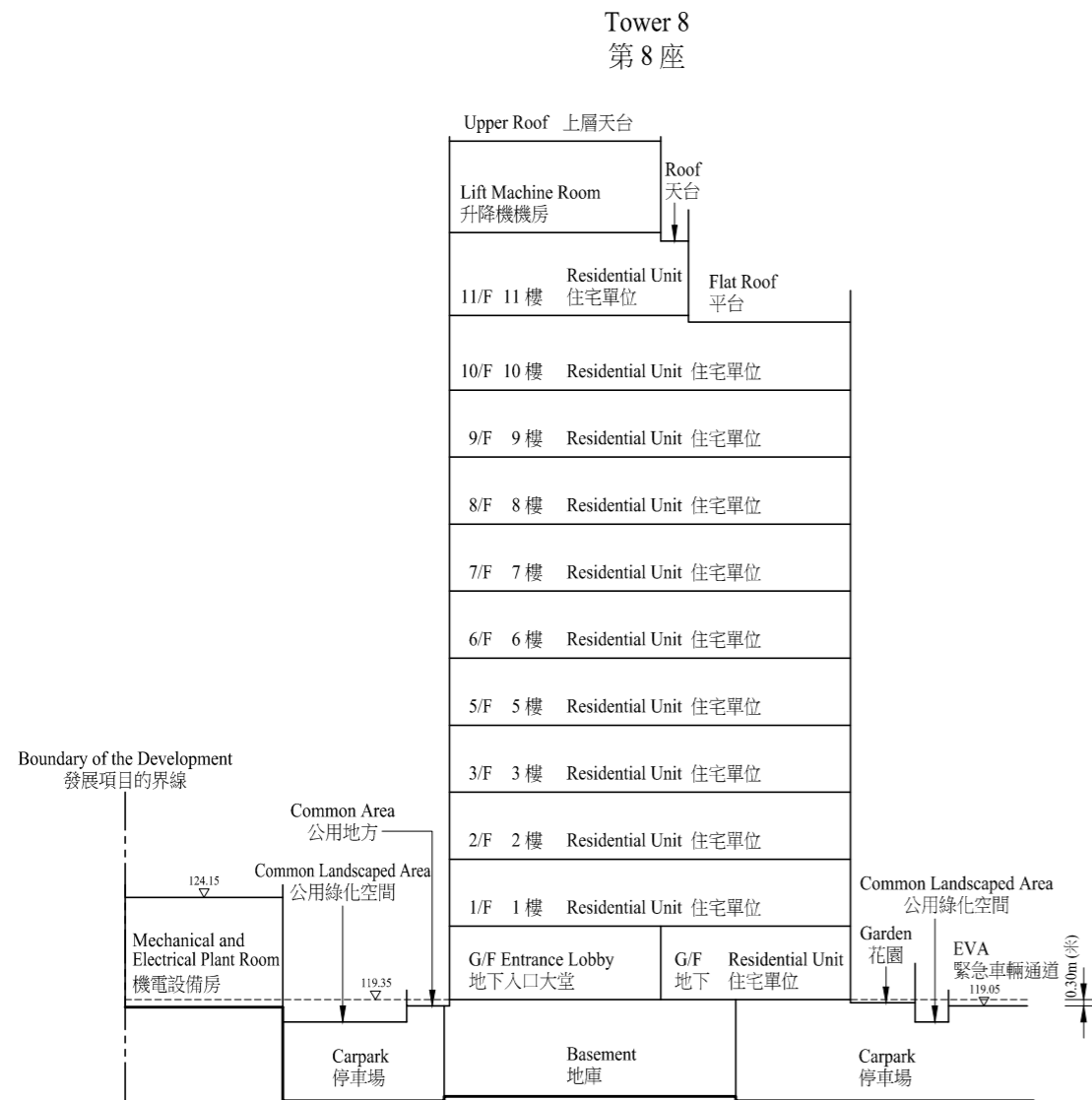

Cross-section Plan (25)  
橫截面圖 (25)

The part of Emergency Vehicular Access (EVA) adjacent to the building is 119.05 metres above the Hong Kong Principal Datum.  
毗連建築物的一段緊急車輛通道為香港主水平基準以上 119.05 米。

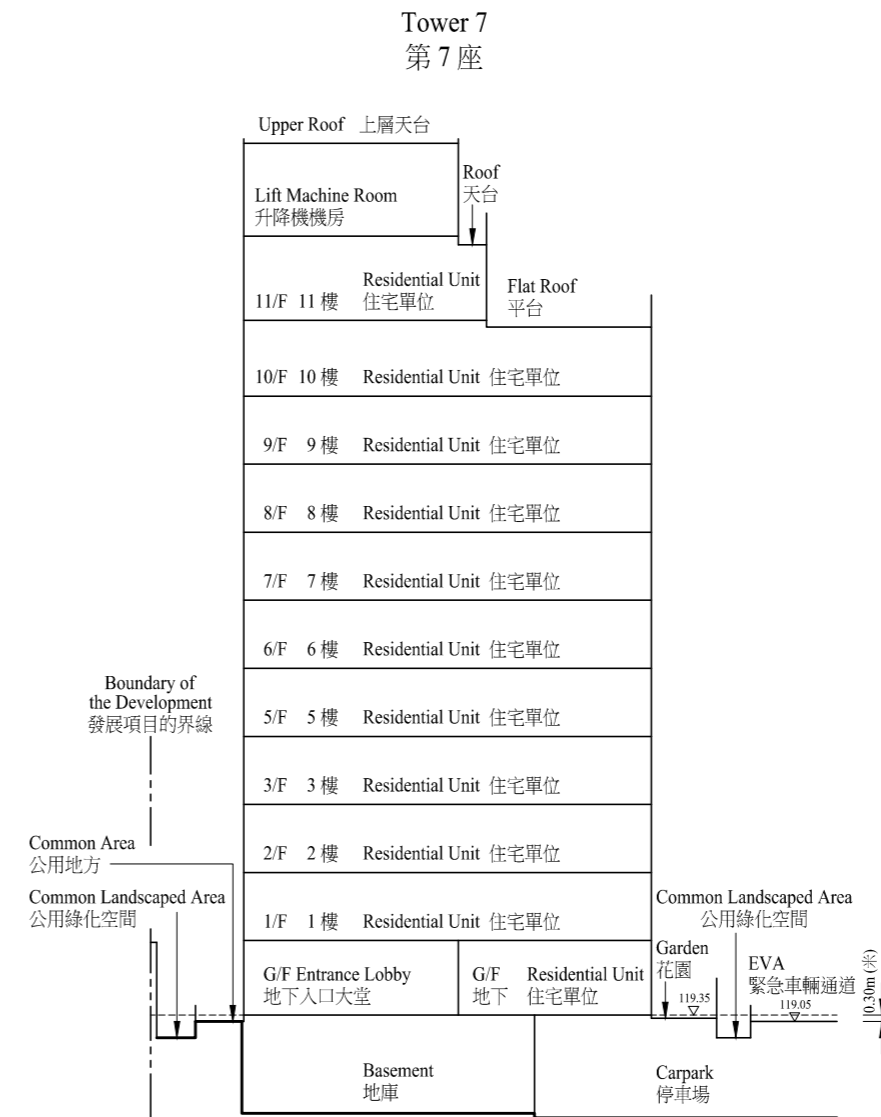

Cross-section Plan (26)  
橫截面圖 (26)

The part of Emergency Vehicular Access (EVA) adjacent to the building is 119.05 metres above the Hong Kong Principal Datum.  
毗連建築物的一段緊急車輛通道為香港主水平基準以上 119.05 米。

-----Dotted line denotes the lowest residential floor.  
虛線為最低住宅樓層水平。

▽ Denotes height (in metres) above the Hong Kong Principal Datum.  
代表香港主水平基準以上的高度(米)。

# CROSS-SECTION PLAN OF BUILDING IN THE DEVELOPMENT

## 發展項目中的建築物的橫截面圖

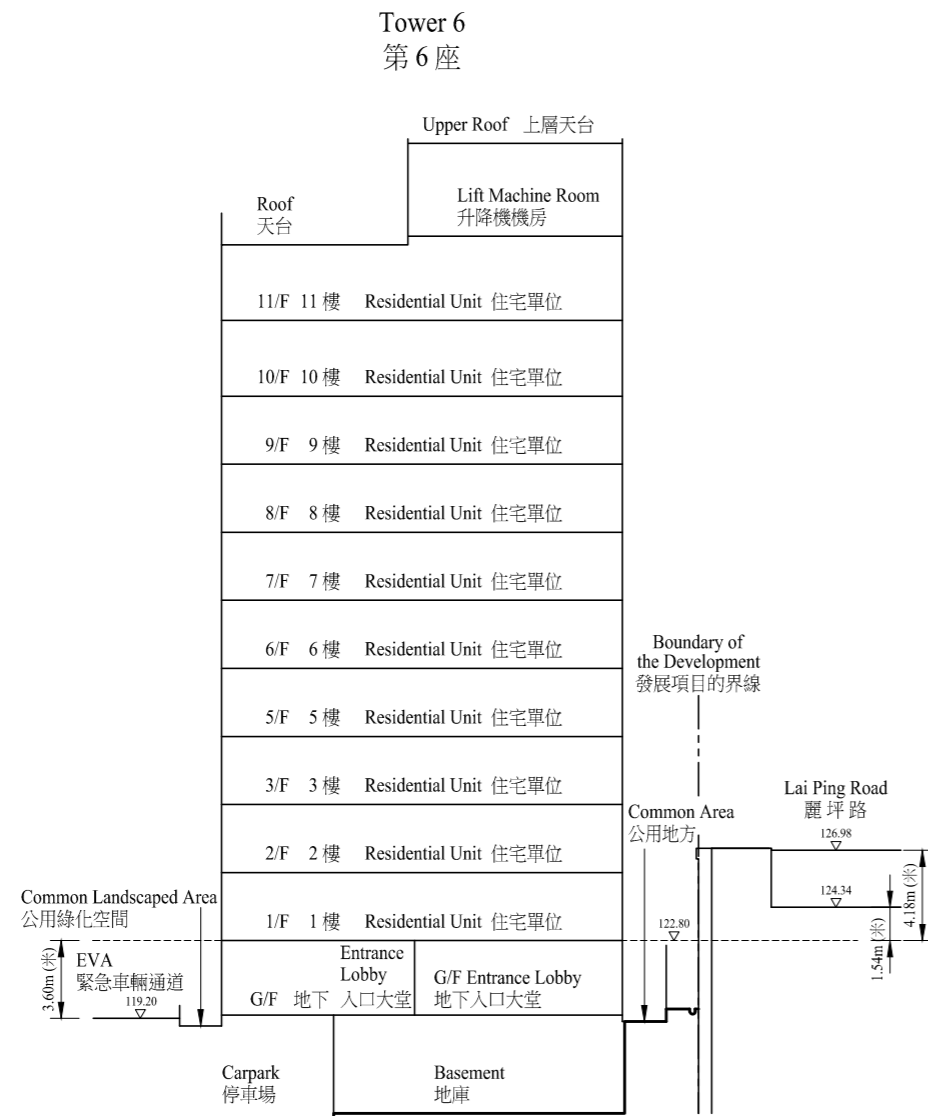

Cross-section Plan (27)  
橫截面圖 (27)

The part of Lai Ping Road adjacent to the building is 124.34 to 126.98 metres above the Hong Kong Principal Datum.  
毗連建築物的一段麗坪路為香港主水平基準以上 124.34 至 126.98 米。

The part of Emergency Vehicular Access (EVA) adjacent to the building is 119.20 metres above the Hong Kong Principal Datum.  
毗連建築物的一段緊急車輛通道為香港主水平基準以上 119.20 米。

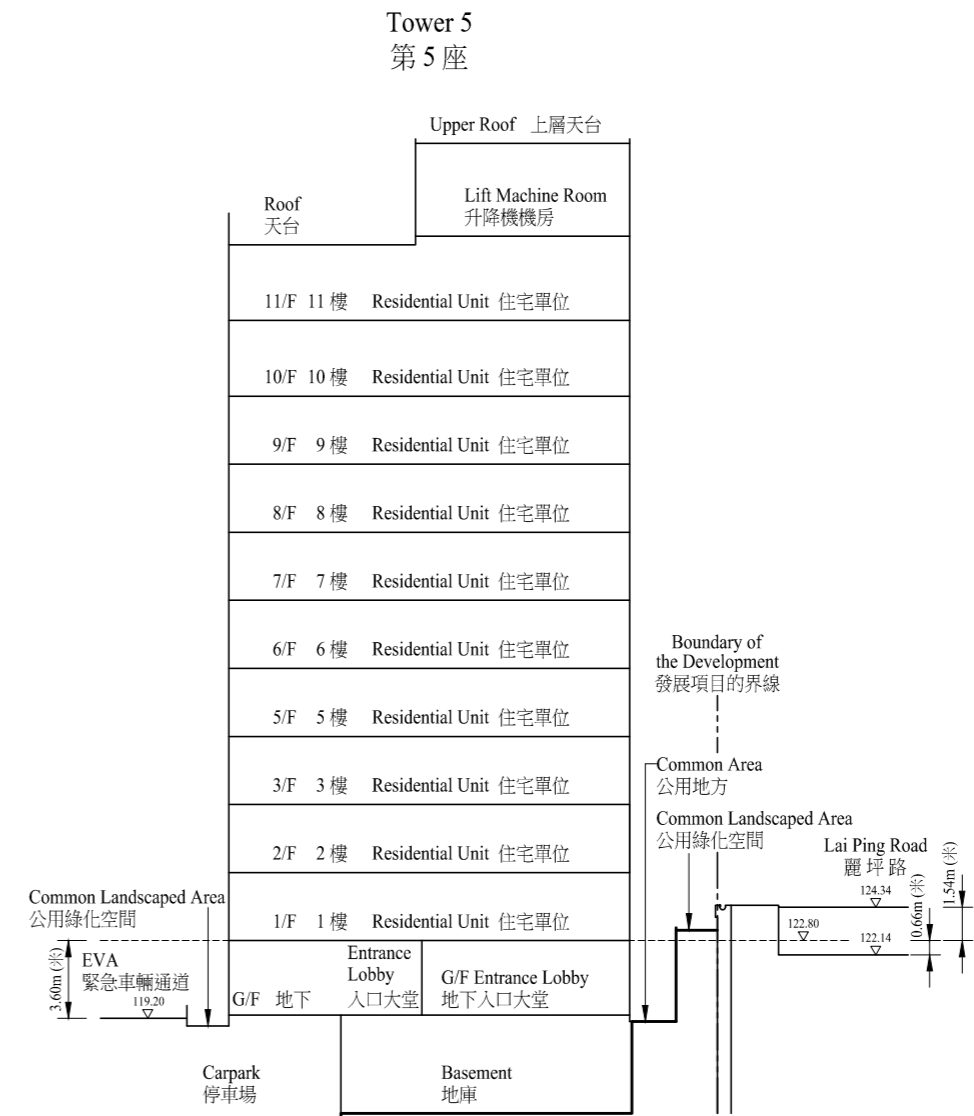

Cross-section Plan (28)  
橫截面圖 (28)

The part of Lai Ping Road adjacent to the building is 122.14 to 124.34 metres above the Hong Kong Principal Datum.  
毗連建築物的一段麗坪路為香港主水平基準以上 122.14 至 124.34 米。

The part of Emergency Vehicular Access (EVA) adjacent to the building is 119.20 metres above the Hong Kong Principal Datum.  
毗連建築物的一段緊急車輛通道為香港主水平基準以上 119.20 米。

-----Dotted line denotes the lowest residential floor.  
虛線為最低住宅樓層水平。

▽ Denotes height (in metres) above the Hong Kong Principal Datum.  
代表香港主水平基準以上的高度(米)。

# CROSS-SECTION PLAN OF BUILDING IN THE DEVELOPMENT

## 發展項目中的建築物的橫截面圖

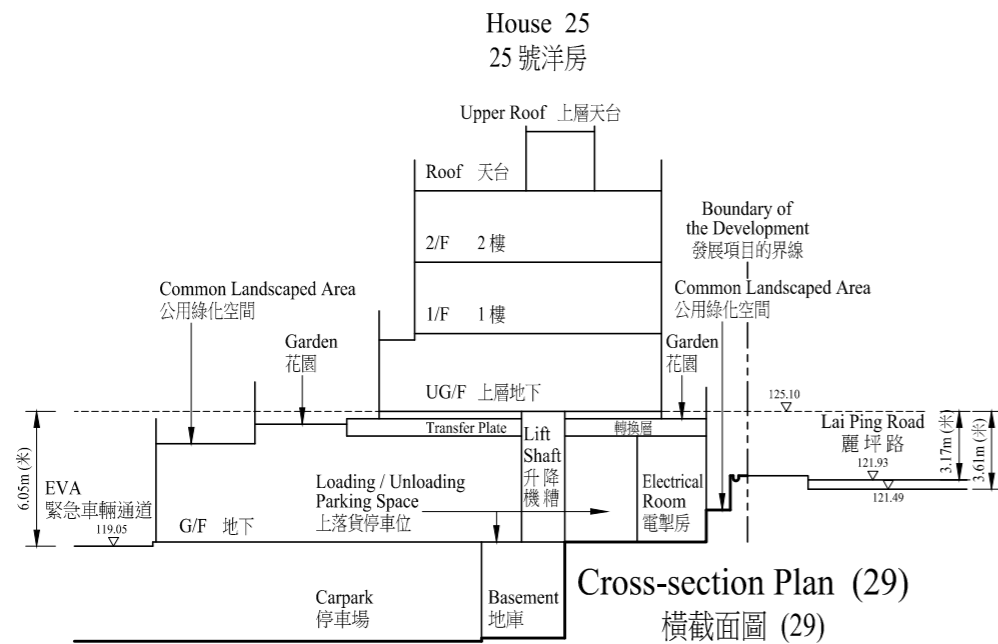

The part of Lai Ping Road adjacent to the building is 121.49 to 121.93 metres above the Hong Kong Principal Datum.  
毗連建築物的一段麗坪路為香港主水平基準以上 121.49 至 121.93 米。

The part of Emergency Vehicular Access (EVA) adjacent to the building is 119.05 metres above the Hong Kong Principal Datum.  
毗連建築物的一段緊急車輛通道為香港主水平基準以上 119.05 米。

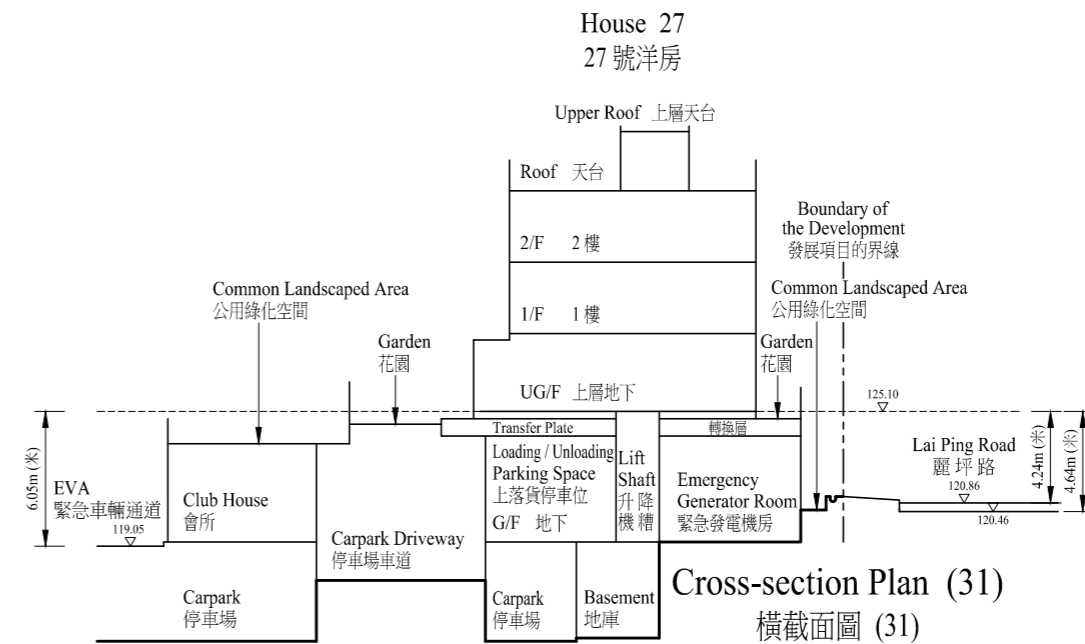

The part of Lai Ping Road adjacent to the building is 120.46 to 120.86 metres above the Hong Kong Principal Datum.  
毗連建築物的一段麗坪路為香港主水平基準以上 120.46 至 120.86 米。

The part of Emergency Vehicular Access (EVA) adjacent to the building is 119.05 metres above the Hong Kong Principal Datum.  
毗連建築物的一段緊急車輛通道為香港主水平基準以上 119.05 米。

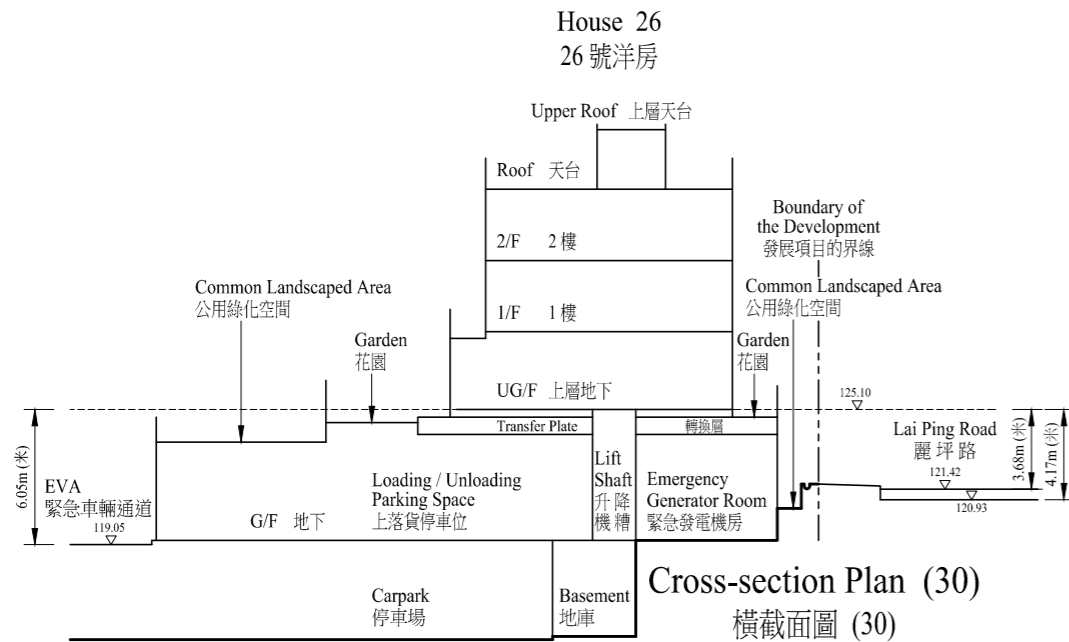

The part of Lai Ping Road adjacent to the building is 120.93 to 121.42 metres above the Hong Kong Principal Datum.  
毗連建築物的一段麗坪路為香港主水平基準以上 120.93 至 121.42 米。

The part of Emergency Vehicular Access (EVA) adjacent to the building is 119.05 metres above the Hong Kong Principal Datum.  
毗連建築物的一段緊急車輛通道為香港主水平基準以上 119.05 米。

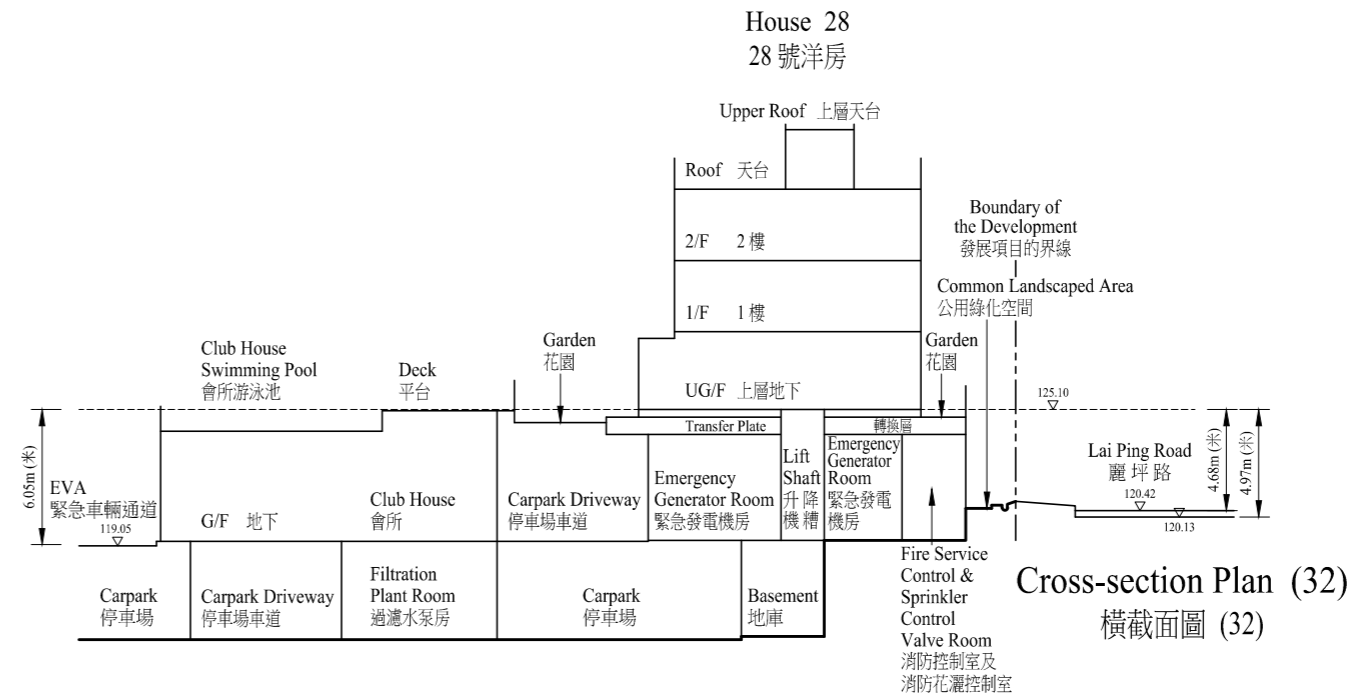

The part of Lai Ping Road adjacent to the building is 120.13 to 120.42 metres above the Hong Kong Principal Datum.  
毗連建築物的一段麗坪路為香港主水平基準以上 120.13 至 120.42 米。

The part of Emergency Vehicular Access (EVA) adjacent to the building is 119.05 metres above the Hong Kong Principal Datum.  
毗連建築物的一段緊急車輛通道為香港主水平基準以上 119.05 米。

-----Dotted line denotes the lowest residential floor.  
虛線為最低住宅樓層水平。

▽ Denotes height (in metres) above the Hong Kong Principal Datum.  
代表香港主水平基準以上的高度(米)。

# ELEVATION PLAN

## 立面圖

### House 1, 2 & 3 1、2 及 3 號洋房

The Authorized Person for the Development has certified that the elevations shown on this plan:  
1. are prepared on the basis of the approved building plans for the Development as at 24 September 2018; and  
2. are in general accordance with the outward appearance of the Development.

發展項目的認可人士已證明本圖所顯示的立面：  
1. 以2018年9月24日此發展項目經批准的建築圖則為基礎擬備；及  
2. 大致上與本項目的外觀一致。

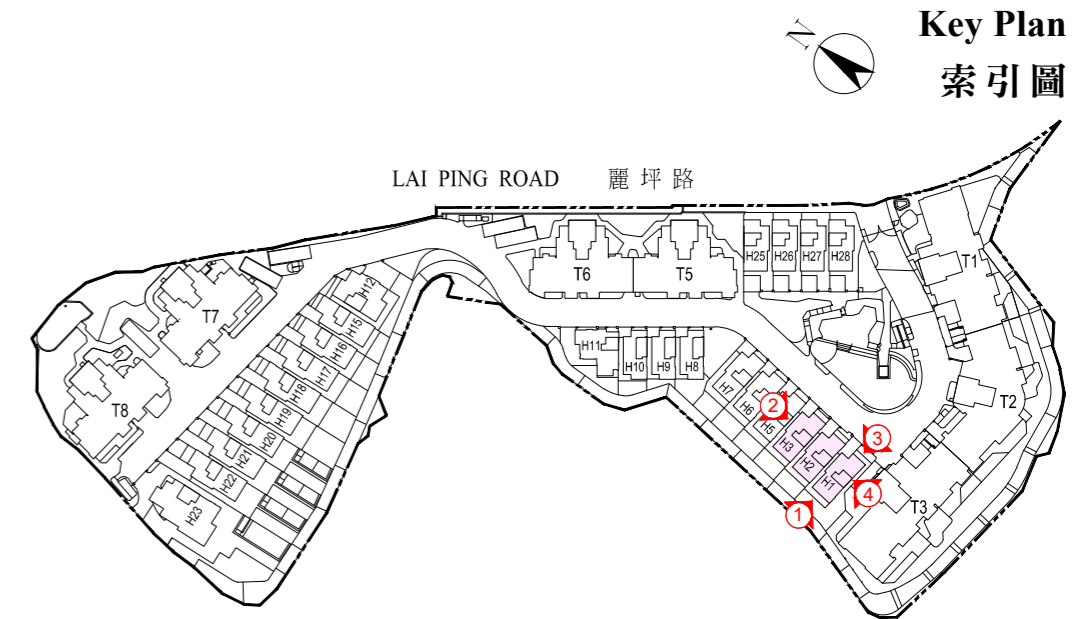

ELEVATION PLAN 1  
立面圖 1



ELEVATION PLAN 2  
立面圖 2



ELEVATION PLAN 3  
立面圖 3

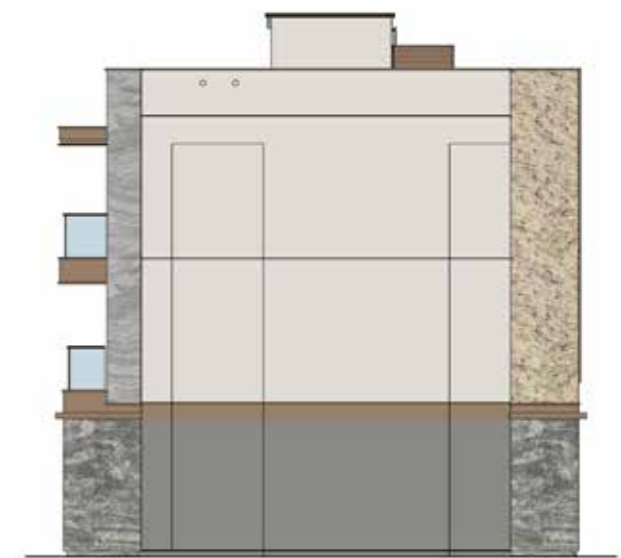

ELEVATION PLAN 4  
立面圖 4

**ELEVATION PLAN**  
**立面圖**

**House 5, 6 & 7**  
**5、6 及 7 號洋房**

The Authorized Person for the Development has certified that the elevations shown on this plan:  
1. are prepared on the basis of the approved building plans for the Development as at 24 September 2018; and  
2. are in general accordance with the outward appearance of the Development.

發展項目的認可人士已證明本圖所顯示的立面：  
1. 以2018年9月24日此發展項目經批准的建築圖則為基礎擬備；及  
2. 大致上與本項目的外觀一致。

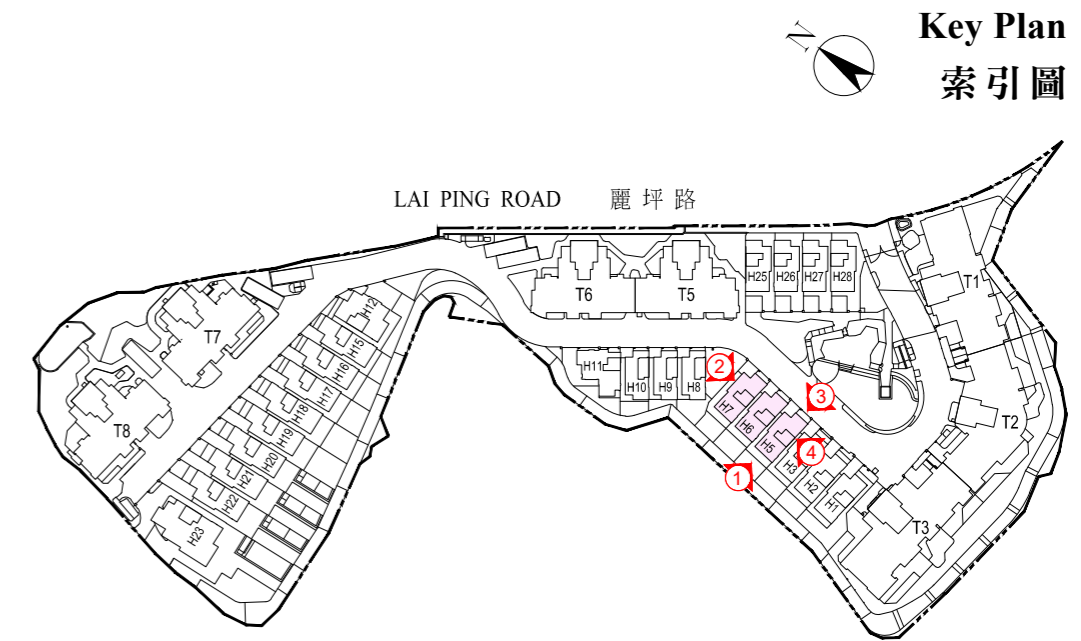

**ELEVATION PLAN 1**  
**立面圖 1**



**ELEVATION PLAN 2**  
**立面圖 2**



**ELEVATION PLAN 3**  
**立面圖 3**

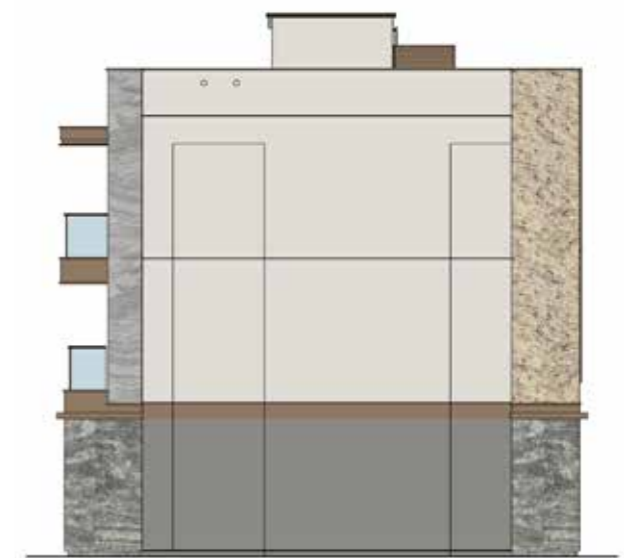

**ELEVATION PLAN 4**  
**立面圖 4**



**ELEVATION PLAN**  
立面圖

**House 8, 9 & 10**  
**8、9 及 10 號洋房**

The Authorized Person for the Development has certified that the elevations shown on this plan:  
1. are prepared on the basis of the approved building plans for the Development as at 24 September 2018; and  
2. are in general accordance with the outward appearance of the Development.

發展項目的認可人士已證明本圖所顯示的立面：  
1. 以2018年9月24日此發展項目經批准的建築圖則為基礎擬備；及  
2. 大致上與本項目的外觀一致。

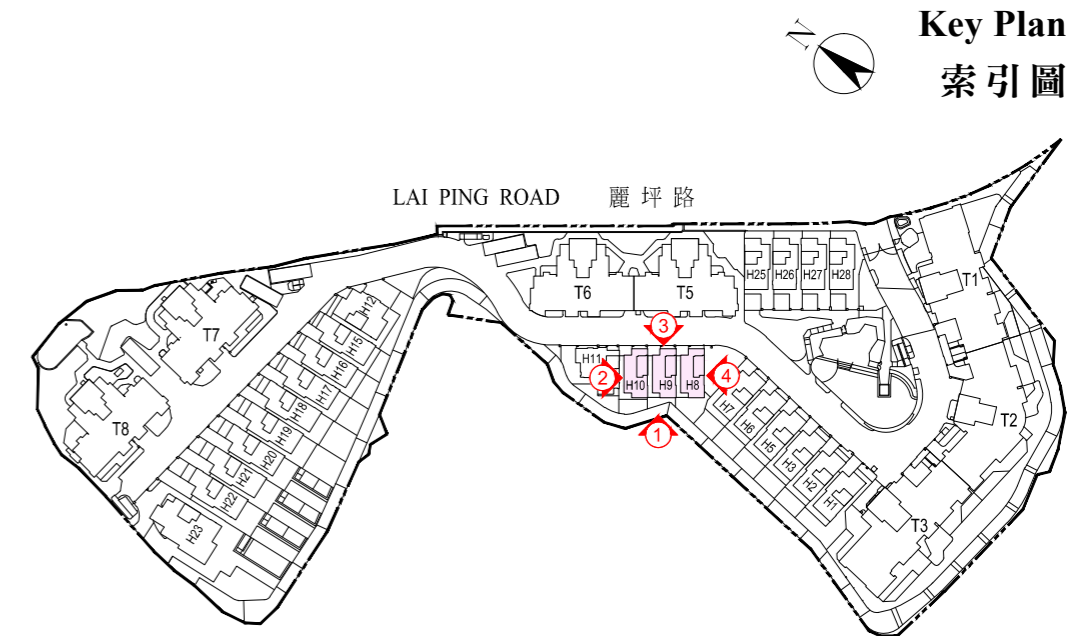

**ELEVATION PLAN 1**  
立面圖 1



**ELEVATION PLAN 2**  
立面圖 2



**ELEVATION PLAN 3**  
立面圖 3

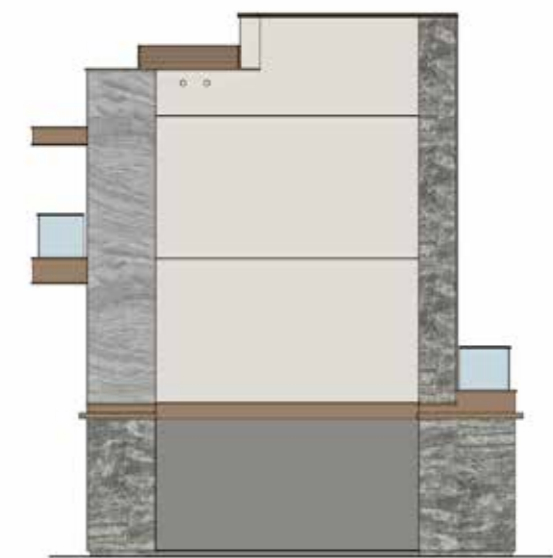

**ELEVATION PLAN 4**  
立面圖 4

# ELEVATION PLAN

## 立面圖

### House 11 11 號洋房

The Authorized Person for the Development has certified that the elevations shown on this plan:  
1. are prepared on the basis of the approved building plans for the Development as at 24 September 2018; and  
2. are in general accordance with the outward appearance of the Development.

發展項目的認可人士已證明本圖所顯示的立面：  
1. 以2018年9月24日此發展項目經批准的建築圖則為基礎擬備；及  
2. 大致上與本項目的外觀一致。



ELEVATION PLAN 1  
立面圖 1



ELEVATION PLAN 2  
立面圖 2



ELEVATION PLAN 3  
立面圖 3

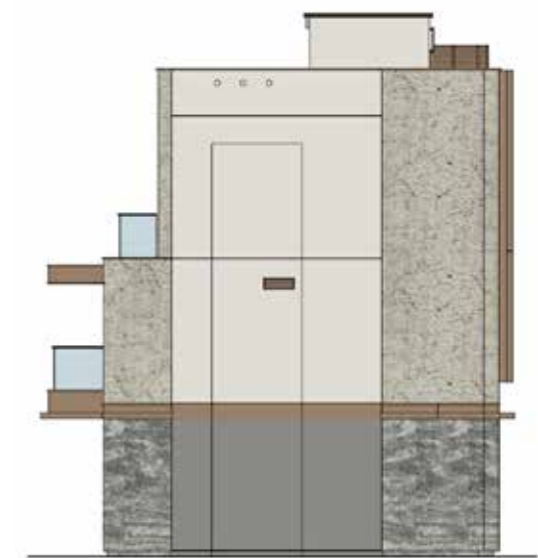

ELEVATION PLAN 4  
立面圖 4

# ELEVATION PLAN

## 立面圖

### House 12 12 號洋房

The Authorized Person for the Development has certified that the elevations shown on this plan:  
1. are prepared on the basis of the approved building plans for the Development as at 24 September 2018; and  
2. are in general accordance with the outward appearance of the Development.

發展項目的認可人士已證明本圖所顯示的立面：  
1. 以2018年9月24日此發展項目經批准的建築圖則為基礎擬備；及  
2. 大致上與本項目的外觀一致。

### Key Plan 索引圖



ELEVATION PLAN 1  
立面圖 1



ELEVATION PLAN 2  
立面圖 2



ELEVATION PLAN 3  
立面圖 3

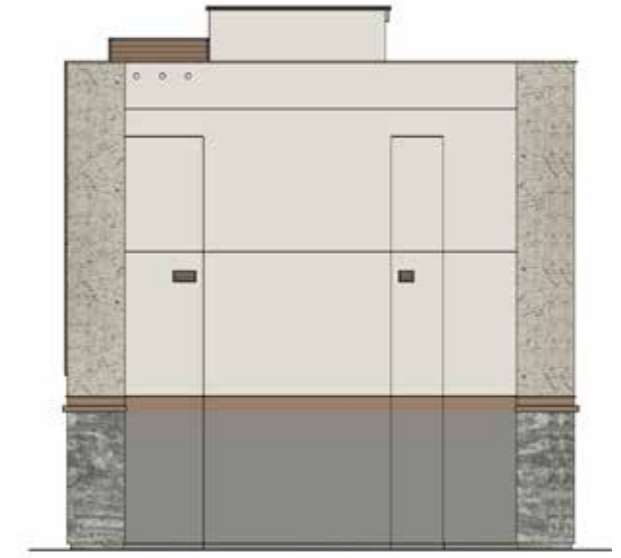

ELEVATION PLAN 4  
立面圖 4

# ELEVATION PLAN

## 立面圖

### House 15, 16, 17, 18, 19, 20, 21 & 22 15、16、17、18、19、20、21 及 22 號洋房

The Authorized Person for the Development has certified that the elevations shown on this plan:  
1. are prepared on the basis of the approved building plans for the Development as at 24 September 2018; and  
2. are in general accordance with the outward appearance of the Development.

發展項目的認可人士已證明本圖所顯示的立面：  
1. 以2018年9月24日此發展項目經批准的建築圖則為基礎擬備；及  
2. 大致上與本項目的外觀一致。

### Key Plan 索引圖

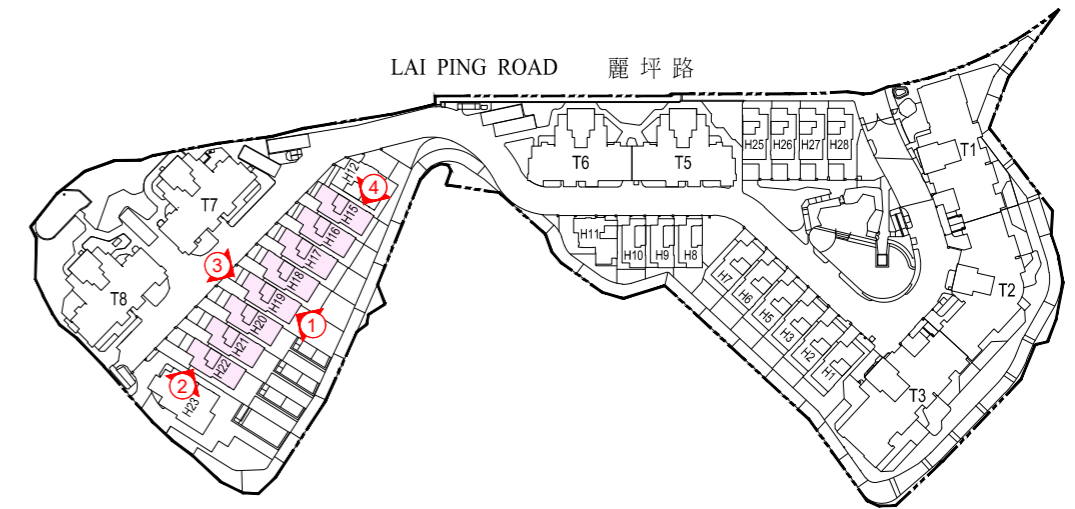

ELEVATION PLAN 1  
立面圖 1



ELEVATION PLAN 2  
立面圖 2



ELEVATION PLAN 3  
立面圖 3

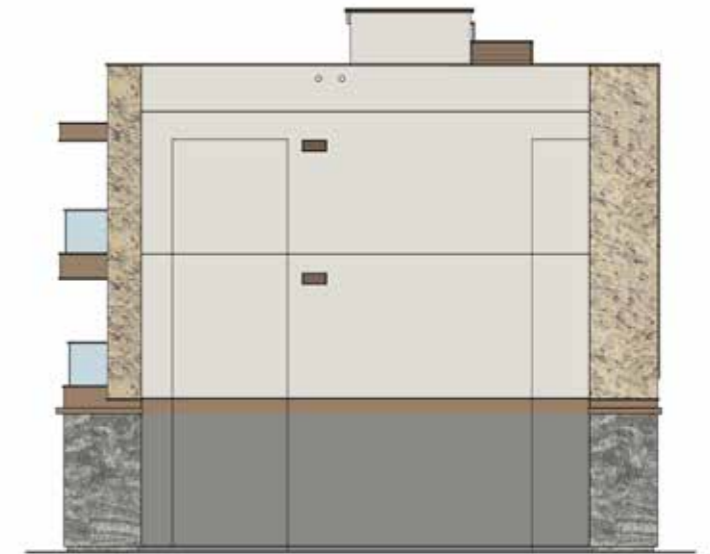

ELEVATION PLAN 4  
立面圖 4



# ELEVATION PLAN

## 立面圖

### House 23 23 號洋房

The Authorized Person for the Development has certified that the elevations shown on this plan:  
1. are prepared on the basis of the approved building plans for the Development as at 24 September 2018; and  
2. are in general accordance with the outward appearance of the Development.

發展項目的認可人士已證明本圖所顯示的立面：  
1. 以2018年9月24日此發展項目經批准的建築圖則為基礎擬備；及  
2. 大致上與本項目的外觀一致。

### Key Plan 索引圖

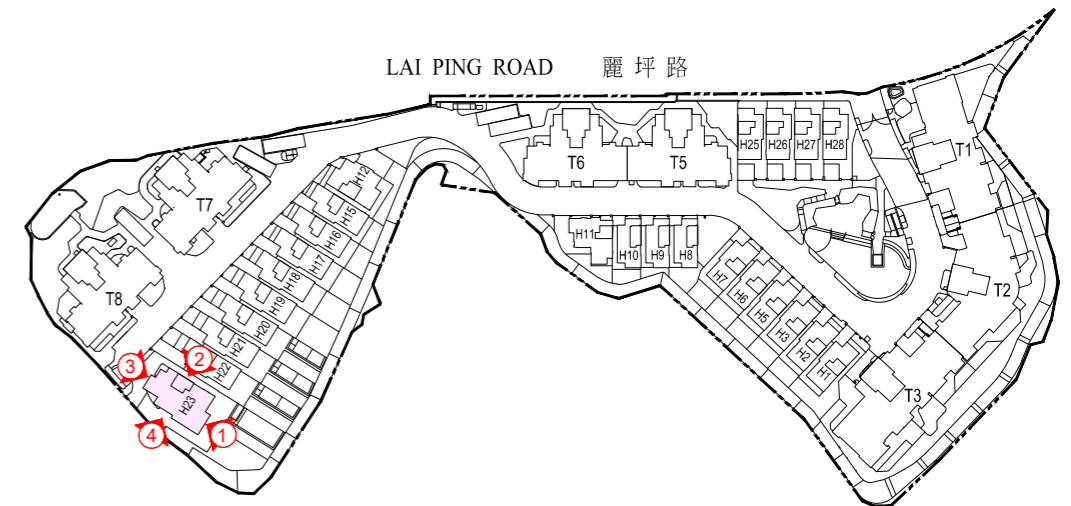

ELEVATION PLAN 1  
立面圖 1



ELEVATION PLAN 2  
立面圖 2

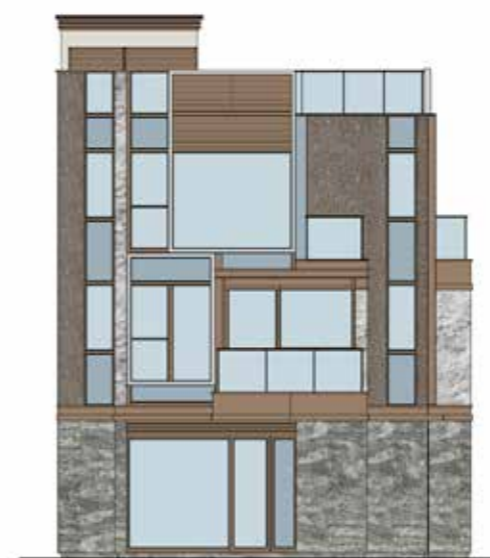

ELEVATION PLAN 3  
立面圖 3



ELEVATION PLAN 4  
立面圖 4



# ELEVATION PLAN

## 立面圖

### House 25, 26 & 27 25、26 及 27 號洋房

The Authorized Person for the Development has certified that the elevations shown on this plan:  
1. are prepared on the basis of the approved building plans for the Development as at 24 September 2018; and  
2. are in general accordance with the outward appearance of the Development.

發展項目的認可人士已證明本圖所顯示的立面：  
1. 以2018年9月24日此發展項目經批准的建築圖則為基礎擬備；及  
2. 大致上與本項目的外觀一致。

### Key Plan 索引圖

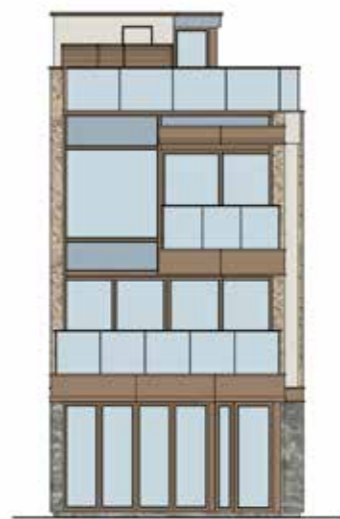

ELEVATION PLAN 1  
立面圖 1

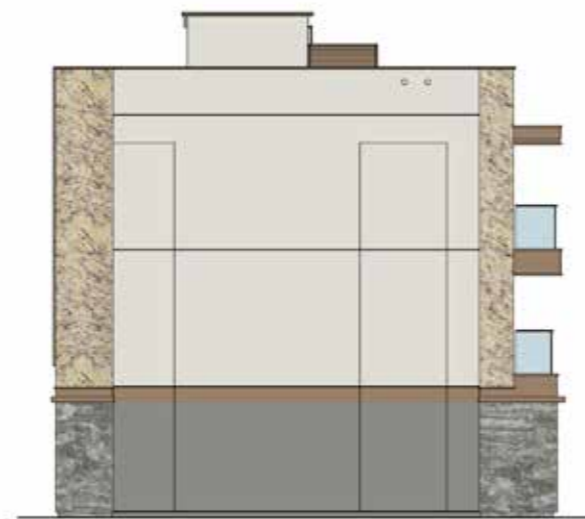

ELEVATION PLAN 2  
立面圖 2



ELEVATION PLAN 3  
立面圖 3

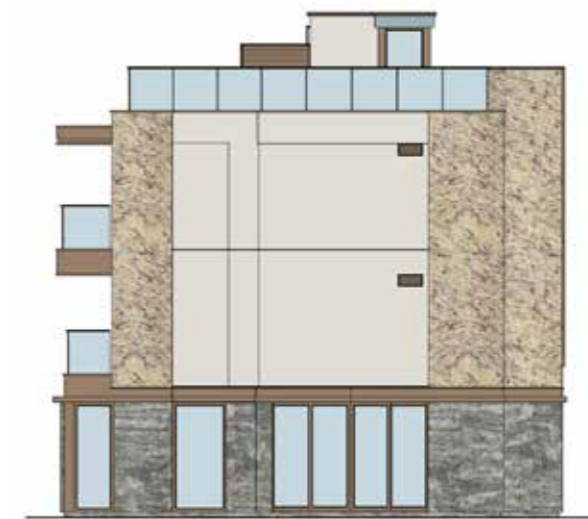

ELEVATION PLAN 4  
立面圖 4

# ELEVATION PLAN

## 立面圖

### House 28 28 號洋房

The Authorized Person for the Development has certified that the elevations shown on this plan:  
1. are prepared on the basis of the approved building plans for the Development as at 24 September 2018; and  
2. are in general accordance with the outward appearance of the Development.

發展項目的認可人士已證明本圖所顯示的立面：  
1. 以2018年9月24日此發展項目經批准的建築圖則為基礎擬備；及  
2. 大致上與本項目的外觀一致。

### Key Plan 索引圖

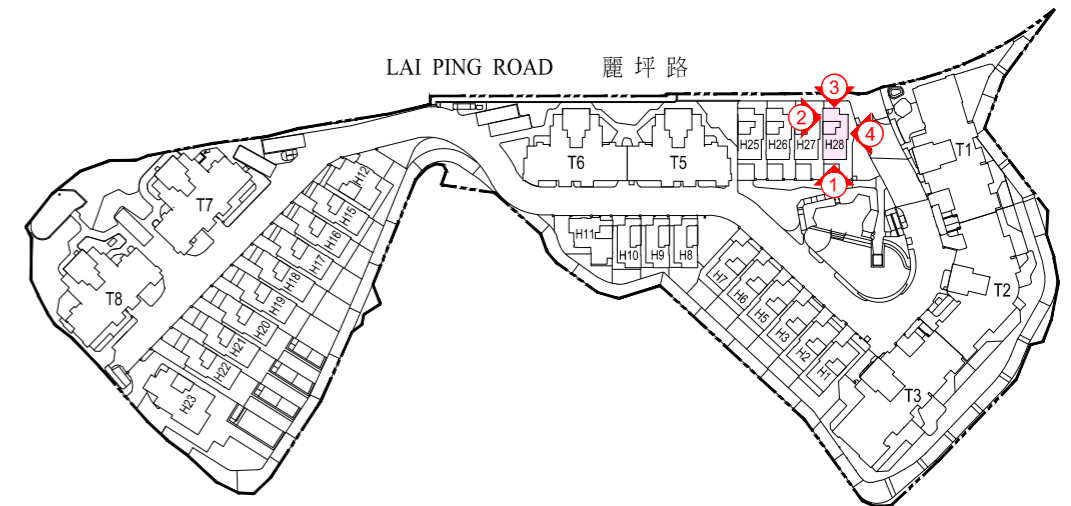

ELEVATION PLAN 1  
立面圖 1

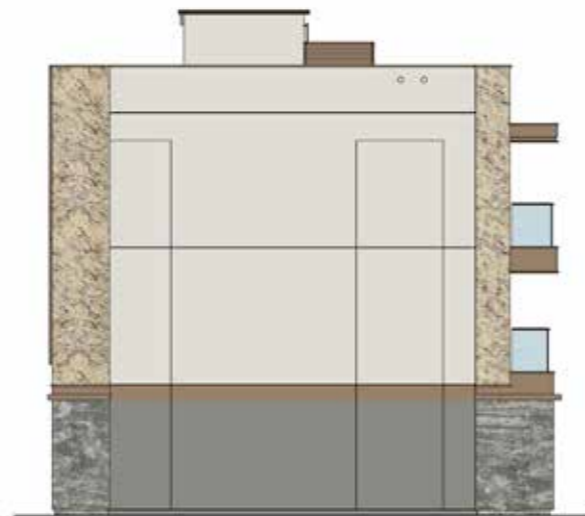

ELEVATION PLAN 2  
立面圖 2



ELEVATION PLAN 3  
立面圖 3



ELEVATION PLAN 4  
立面圖 4

### Tower 1 第1座

The Authorized Person for the Development has certified that the elevations shown on this plan:  
1. are prepared on the basis of the approved building plans for the Development as at 24 September 2018; and  
2. are in general accordance with the outward appearance of the Development.

發展項目的認可人士已證明本圖所顯示的立面：  
1. 以2018年9月24日此發展項目經批准的建築圖則為基礎擬備；及  
2. 大致上與本項目的外觀一致。

### Key Plan 索引圖

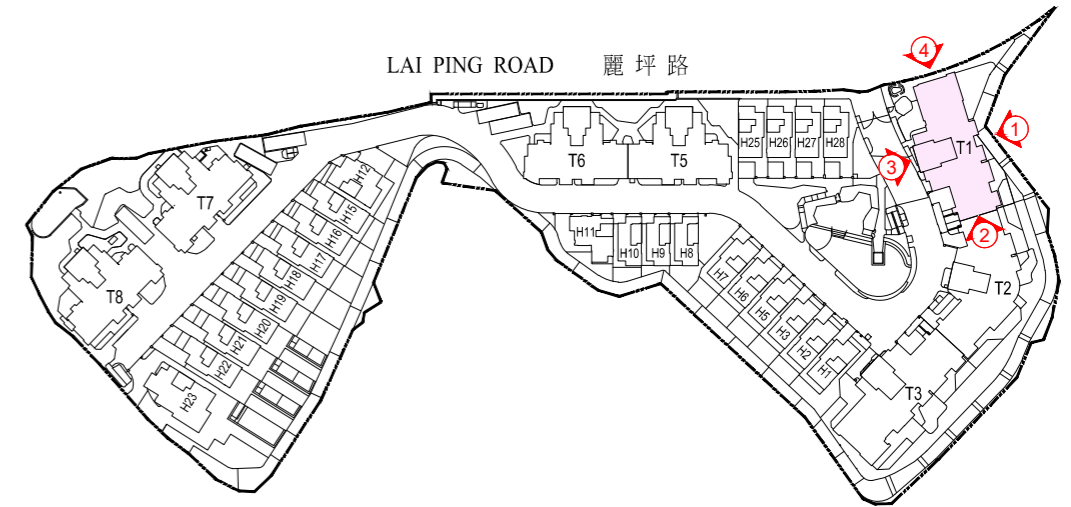

ELEVATION PLAN 1  
立面圖 1

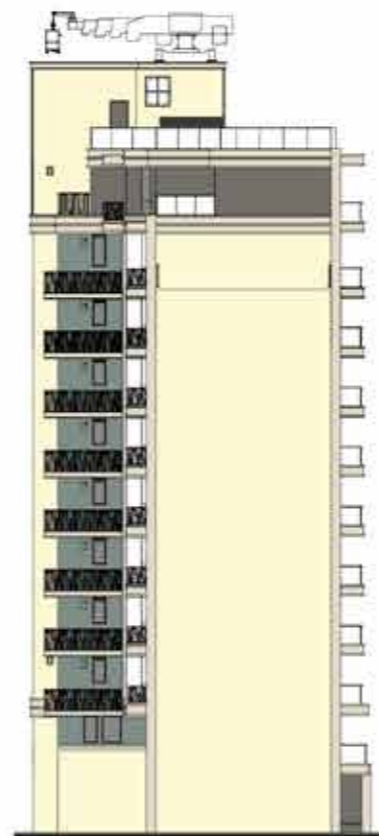

ELEVATION PLAN 2  
立面圖 2



ELEVATION PLAN 3  
立面圖 3



ELEVATION PLAN 4  
立面圖 4



# ELEVATION PLAN

## 立面圖

### Tower 2 第2座

The Authorized Person for the Development has certified that the elevations shown on this plan:  
1. are prepared on the basis of the approved building plans for the Development as at 24 September 2018; and  
2. are in general accordance with the outward appearance of the Development.

發展項目的認可人士已證明本圖所顯示的立面：  
1. 以2018年9月24日此發展項目經批准的建築圖則為基礎擬備；及  
2. 大致上與本項目的外觀一致。

### Key Plan 索引圖

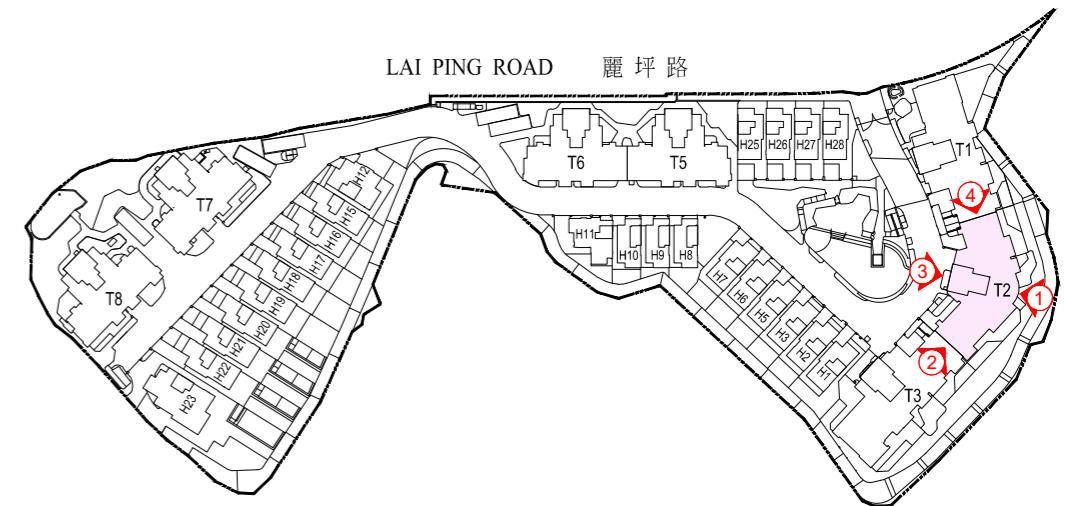

ELEVATION PLAN 1  
立面圖 1

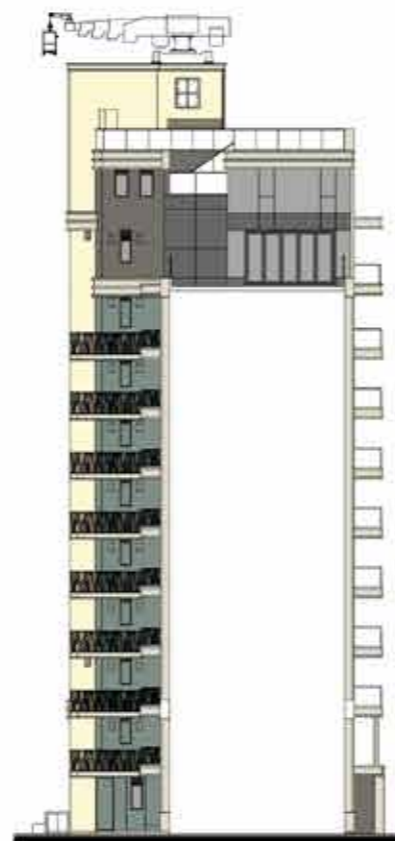

ELEVATION PLAN 2  
立面圖 2



ELEVATION PLAN 3  
立面圖 3



ELEVATION PLAN 4  
立面圖 4

### Tower 3 第3座

The Authorized Person for the Development has certified that the elevations shown on this plan:  
1. are prepared on the basis of the approved building plans for the Development as at 24 September 2018; and  
2. are in general accordance with the outward appearance of the Development.

發展項目的認可人士已證明本圖所顯示的立面：  
1. 以2018年9月24日此發展項目經批准的建築圖則為基礎擬備；及  
2. 大致上與本項目的外觀一致。

### Key Plan 索引圖

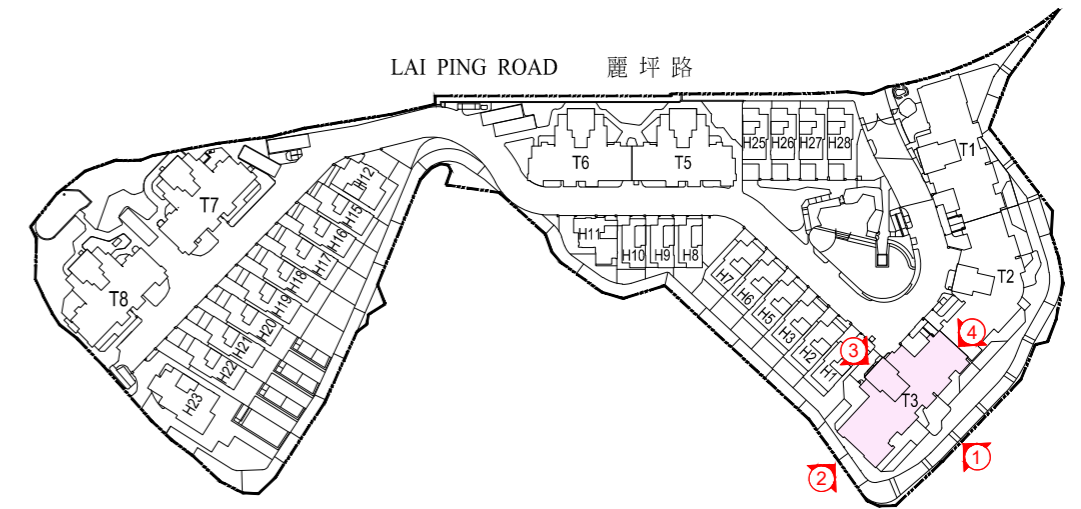

ELEVATION PLAN 1  
立面圖 1

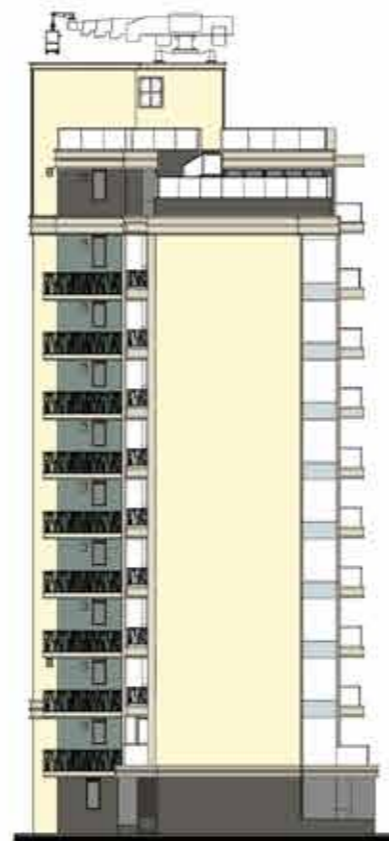

ELEVATION PLAN 2  
立面圖 2



ELEVATION PLAN 3  
立面圖 3

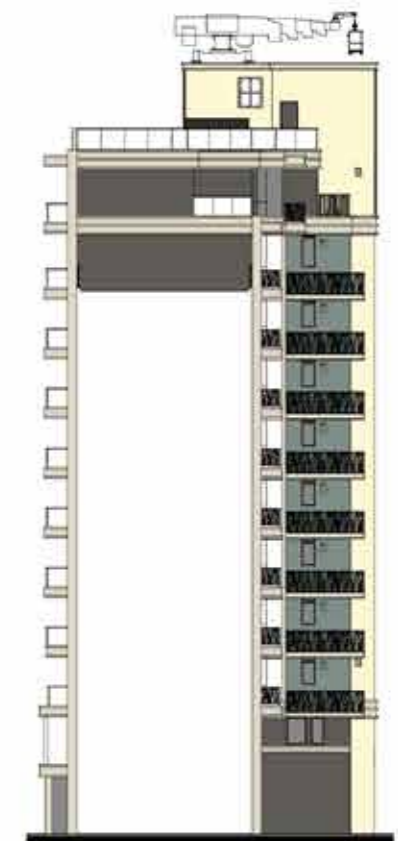

ELEVATION PLAN 4  
立面圖 4



# ELEVATION PLAN

## 立面圖

### Tower 5 第5座

The Authorized Person for the Development has certified that the elevations shown on this plan:  
1. are prepared on the basis of the approved building plans for the Development as at 24 September 2018; and  
2. are in general accordance with the outward appearance of the Development.

發展項目的認可人士已證明本圖所顯示的立面：  
1. 以2018年9月24日此發展項目經批准的建築圖則為基礎擬備；及  
2. 大致上與本項目的外觀一致。

### Key Plan 索引圖

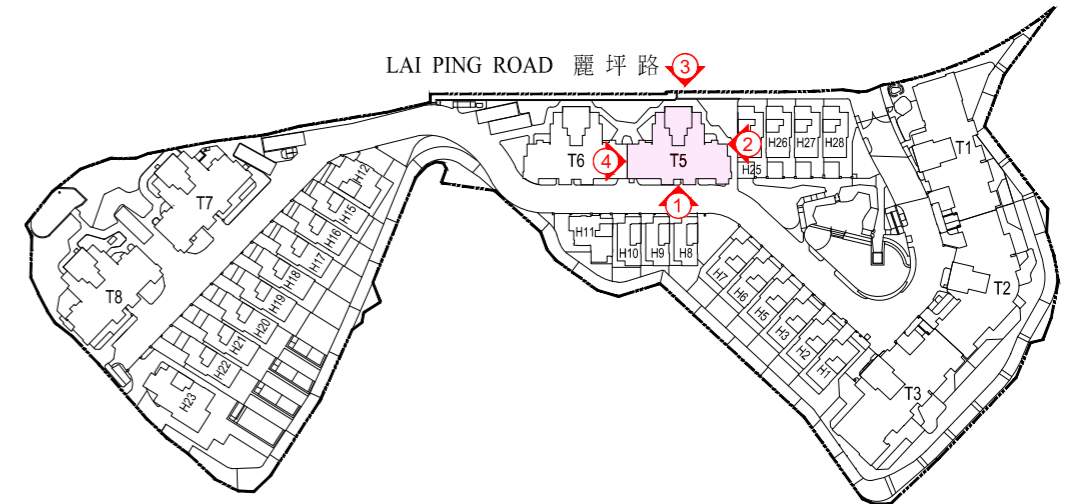

ELEVATION PLAN 1  
立面圖 1



ELEVATION PLAN 2  
立面圖 2



ELEVATION PLAN 3  
立面圖 3

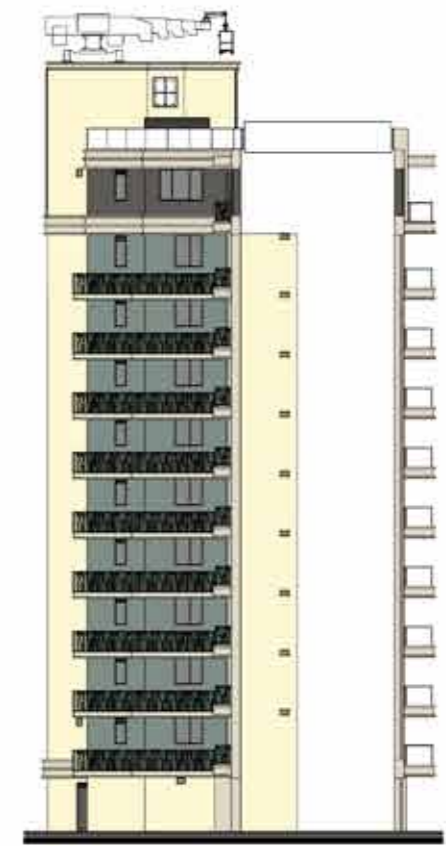

ELEVATION PLAN 4  
立面圖 4

### Tower 6 第 6 座

The Authorized Person for the Development has certified that the elevations shown on this plan:  
1. are prepared on the basis of the approved building plans for the Development as at 24 September 2018; and  
2. are in general accordance with the outward appearance of the Development.

發展項目的認可人士已證明本圖所顯示的立面：  
1. 以2018年9月24日此發展項目經批准的建築圖則為基礎擬備；及  
2. 大致上與本項目的外觀一致。

Key Plan  
索引圖

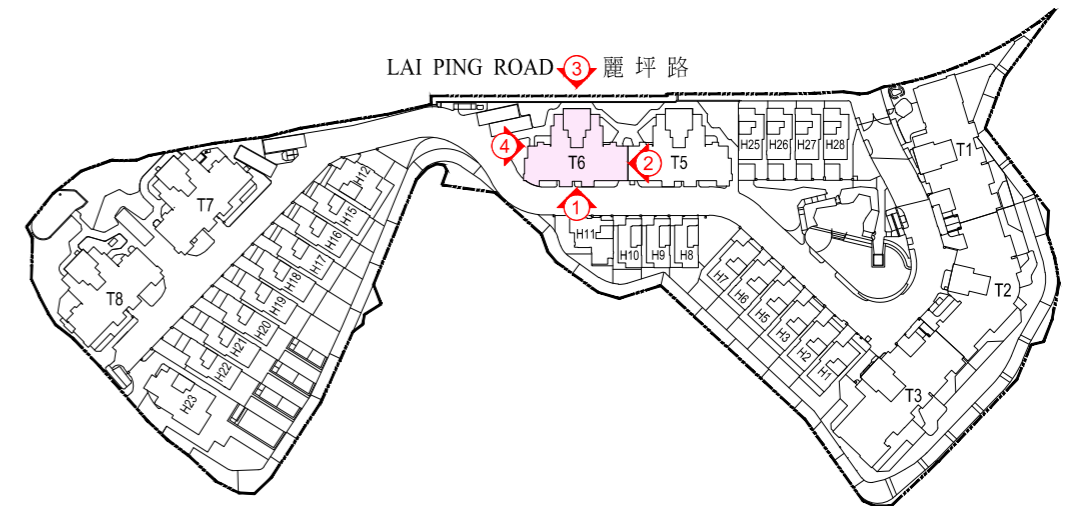

ELEVATION PLAN 1  
立面圖 1

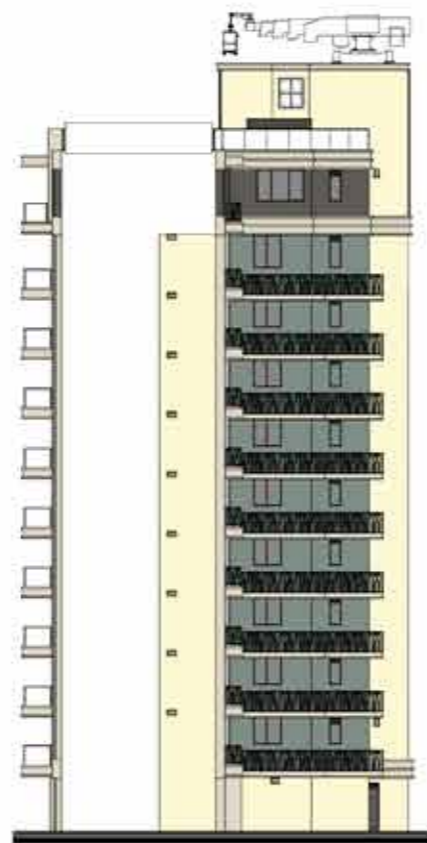

ELEVATION PLAN 2  
立面圖 2



ELEVATION PLAN 3  
立面圖 3



ELEVATION PLAN 4  
立面圖 4



# ELEVATION PLAN

## 立面圖

### Tower 7 第 7 座

The Authorized Person for the Development has certified that the elevations shown on this plan:  
1. are prepared on the basis of the approved building plans for the Development as at 24 September 2018; and  
2. are in general accordance with the outward appearance of the Development.

發展項目的認可人士已證明本圖所顯示的立面：  
1. 以2018年9月24日此發展項目經批准的建築圖則為基礎擬備；及  
2. 大致上與本項目的外觀一致。

### Key Plan 索引圖

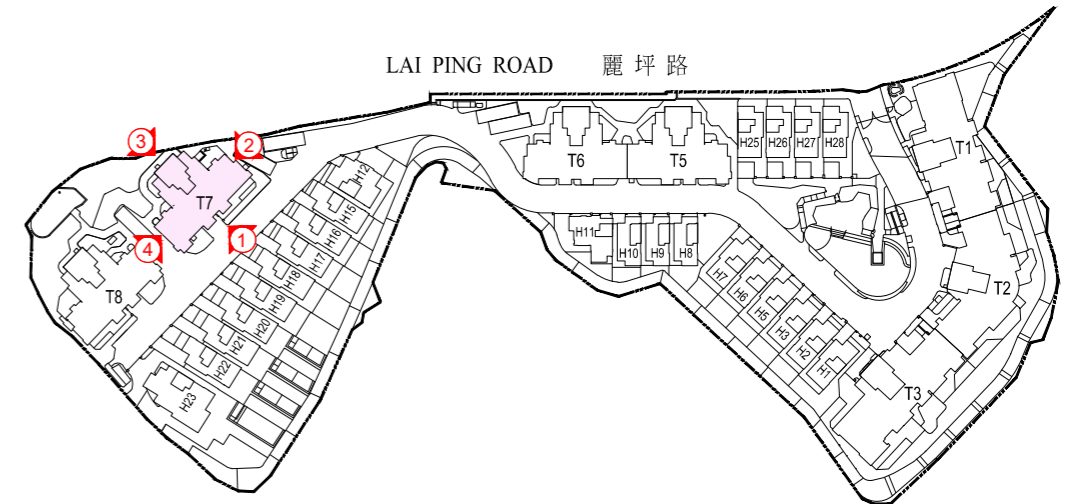

ELEVATION PLAN 1  
立面圖 1



ELEVATION PLAN 2  
立面圖 2



ELEVATION PLAN 3  
立面圖 3



ELEVATION PLAN 4  
立面圖 4

# ELEVATION PLAN

## 立面圖

### Tower 8 第 8 座

The Authorized Person for the Development has certified that the elevations shown on this plan:  
1. are prepared on the basis of the approved building plans for the Development as at 24 September 2018; and  
2. are in general accordance with the outward appearance of the Development.

發展項目的認可人士已證明本圖所顯示的立面：  
1. 以2018年9月24日此發展項目經批准的建築圖則為基礎擬備；及  
2. 大致上與本項目的外觀一致。

### Key Plan 索引圖

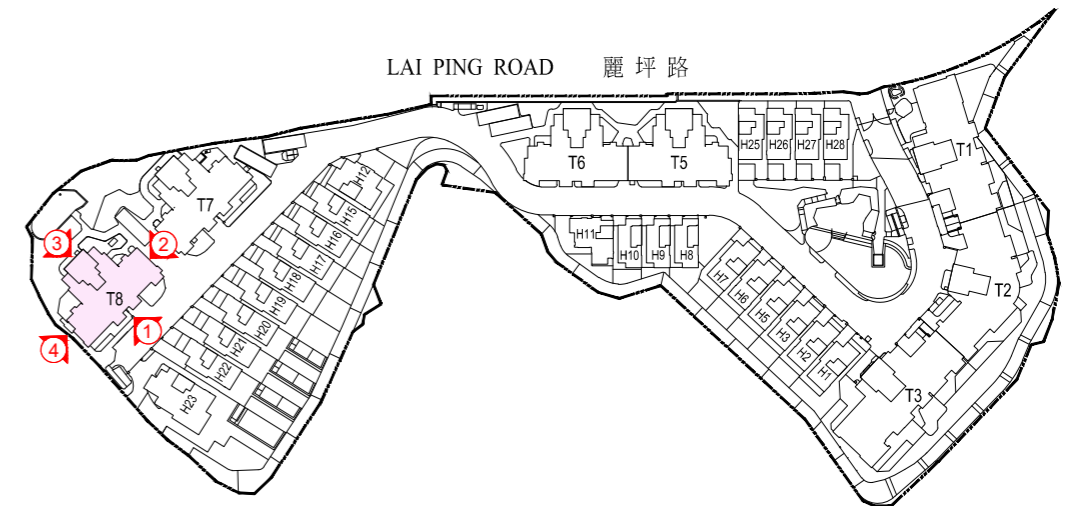

ELEVATION PLAN 1  
立面圖 1



ELEVATION PLAN 2  
立面圖 2



ELEVATION PLAN 3  
立面圖 3



ELEVATION PLAN 4  
立面圖 4

## INFORMATION ON COMMON FACILITIES IN THE DEVELOPMENT

### 發展項目中的公用設施的資料

Category of Common Facilities 公用設施的類別	Covered Area 有蓋面積 sq. m. 平方米 (sq. ft. 平方呎)	Uncovered Area 無蓋面積 sq. m. 平方米 (sq. ft. 平方呎)	Total Area 總面積 sq. m. 平方米 (sq. ft. 平方呎)
Residents' Clubhouse (including any recreational facilities for residents' use) 住客會所 (包括供住客使用的任何康樂設施)	1428.868 (15380)	414.236 (4459)	1843.104 (19839)
Communal garden or play area for residents' use on the roof, or on any floor between the roof and the lowest residential floor, of a building in the Development (whether known as a communal sky garden or otherwise) 位於發展項目中的建築物的天台或在天台和最低一層住宅樓層之間的任何一層的、供住客使用的公用花園或遊樂地方 (不論是稱為公用空中花園或有其他名稱)	Not Applicable 不適用	303.341 (3265)	303.341 (3265)
Communal garden or play area for residents' use below the lowest residential floor of a building in the Development (whether known as a covered and landscaped play area or otherwise) 位於發展項目中的建築物的最低一層住宅樓層以下的、供住客使用的公用花園或遊樂地方 (不論是稱為有蓋及園景的遊樂場或有其他名稱)	298.133 (3209)	2118.667 (22805)	2416.800 (26014)

**Note:**

The areas as specified above in square feet are converted from the area in square metre at a rate of 1 square metre = 10.764 square feet and rounded off to the nearest whole square foot, which may be slightly different from the area presented in square metres.

**備註:**

上述以平方呎表述之面積由以平方米表述之面積以1平方米 = 10.764平方呎換算並四捨五入至整數平方呎之方法計算得出，與以平方米表述之面積可能有些微差異。



## INSPECTION OF PLANS AND DEED OF MUTUAL COVENANT

### 閱覽圖則及公契

1. Copy of the outline zoning plan relating to the Development is available at <http://www.ozp.tpb.gov.hk>
2. A copy of the latest draft of every deed of mutual covenant in respect of the specified residential property as at the date on which the specified residential property is offered to be sold is available for inspection free of charge at the place at which the specified residential properties is offered to be sold.

1. 備有關乎本發展項目的分區計劃大綱圖的文本供閱覽的互聯網網站的網址為 [www.ozp.tpb.gov.hk](http://www.ozp.tpb.gov.hk)。
2. 指明住宅物業的每一公契在將指明住宅物業提供出售的日期的最新擬稿文本存放在指明住宅物業的售樓處，以供免費閱覽。

This page is deliberately left in blank.

此版乃特意留白。

House

1. Exterior Finishes			
Item		Description	
a.	External wall	Type of finishes	Ceramic tiles, curtain walls, aluminium & glass cladding, natural stone claddings
b.	Window	Material of frame	PVF2 aluminium window frame
		Material of glass	Grey tinted glass
c.	Bay window	Material of bay window	Not applicable
		Finishes of window sill	Not applicable
d.	Planter	Type of finishes	Not applicable
e.	Verandah or balcony	Type of finishes	Balcony : Fitted with clear tempered glass balustrade with aluminium handrail
			Floor : Homogeneous floor tiles
			Wall : Aluminium cladding, natural stone cladding
			Ceilings : Emulsion paint to exposed surface of ceiling
		Whether it is covered	Balcony is covered
	Verandah	Not applicable	
f.	Drying facilities for clothing	Type	Not applicable
		Material	Not applicable

2. Interior Finishes			
Item		Description	
a.	Lobby	Type of finishes of Private Lift Lobby on B/F (except House 8-10)	Wall
			Emulsion paint to exposed surface, except: - (a) The exposed surface of House 3 are finished with tiles, stainless steel panel, feature glass (b) The exposed surface of House 20 are finished with timber veneer surface panel, stainless steel panel and feature glass (c) Not applicable for House 23

a.	Lobby	Type of finishes of Private Lift Lobby on B/F (except House 8-10)	Floor	Ceiling
			Engineered timber flooring, except: - (a) House 3 are finished with natural stone (b) House 20 are finished with natural stone and ceramic tiles (c) Not applicable for House 23	Gypsum board false ceiling with emulsion paint to exposed surface, except: - (a) The exposed surface of ceilings of House 3 are equipped with gypsum board false ceiling with emulsion paint and stainless steel panel (b) The exposed surface of ceilings of House 20 are equipped with gypsum board false ceiling with emulsion paint, timber veneer surface panel and feature glass (c) Not applicable for House 23
b.	Internal wall and ceiling	Type of finishes of Living Room & Dining Room	Wall	Ceiling
			Emulsion paint to exposed surface, except: - (a) The exposed wall surface of House 3 are finished with natural stone, stainless steel panel and fabric panel (b) The exposed surface of Living Room of House 20 is finished with natural stone, timber veneer surface panel, stainless steel panel and feature glass (c) The exposed surface of Dining Room of House 20 are finished with timber veneer surface panel and mirror (d) Not applicable for House 23	Exposed surface of ceilings are finished with emulsion paint, some areas are equipped with gypsum board false ceiling with emulsion paint, except: - (a) The exposed surface of ceilings of House 3 are equipped with gypsum board false ceiling with emulsion paint and stainless steel panel (b) The exposed surface of ceilings of Living Room of House 20 are finished with timber veneer surface panel and mirror (c) The exposed surface of ceilings of Dining Room of House 20 are finished with timber veneer surface panel (d) Not applicable for House 23
b.	Internal wall and ceiling	Type of finishes of Bedroom & Ensuite	Emulsion paint to exposed surface, except: - (a) The exposed surface of Master Bedroom of House 3 are finished with natural stone, mirror, stainless steel panel, wall paper, embroidery decorative panel and fabric panel (b) The exposed surface of Ensuite of House 3 are finished with wall paper, mirror and stainless steel panel (c) The exposed surface of House 20 are finished with decorative paint, stainless steel panel, mirror and fabric panel (d) Not applicable for House 23	Exposed surface of ceilings are finished with emulsion paint, some areas are equipped with gypsum board false ceiling with emulsion paint, except: - (a) The exposed surface of House 3 is equipped with gypsum board false ceilings with emulsion paint, feature panel and stainless steel (b) The exposed surface of House 20 is equipped with gypsum board false ceilings with emulsion paint and mirror (c) Not applicable for House 23

# FITTINGS, FINISHES AND APPLIANCES

## 裝置、裝修物料及設備

### 洋房

1. 外部裝修物料			
細項		描述	
a.	外牆	裝修物料的類型	瓷磚、玻璃幕牆、鋁質及玻璃飾板、天然石材飾板
b.	窗	框的用料	氟碳噴塗鋁窗框
		玻璃的用料	灰面強化玻璃
c.	窗台	窗台的用料	不適用
		窗台板的裝修物料	不適用
d.	花槽	裝修物料的類型	不適用
e.	陽台或露台	裝修物料的類型	露台：裝有透明強化玻璃欄配以鋁質扶手
			地台：同心透底瓷磚
			牆身：鋁質飾板、天然石材飾板
			天花：天花外露部份髹上乳膠漆
		是否有蓋	露台有蓋
	陽台	不適用	
f.	乾衣設施	類型	不適用
		用料	不適用

2. 室內裝修物料			
細項		描述	
a.	大堂	地庫電梯大堂裝修物料的類型 (除洋房8至10號)	牆壁
			外露部份髹上乳膠漆。唯:- (a) 3號洋房鋪砌磚、不銹鋼板、特色玻璃 (b) 20號洋房鋪砌木皮飾面板、不銹鋼板及特色玻璃 (c) 不適用於23號洋房

		地板		天花板	
a.	大堂	地庫電梯大堂裝修物料的類型 (除洋房8至10號)	複合木地板。唯:- (a) 3號洋房鋪砌天然石材 (b) 20號洋房鋪砌天然石材及磁磚 (c) 不適用於23號洋房	外露部份鋪砌石膏板假天花，髹上乳膠漆。唯:- (a) (a) 3號洋房的天花板外露部份以石膏板假天花髹上乳膠漆及不銹鋼板鋪砌 (b) 20號洋房的天花板外露部份以石膏板假天花及髹上乳膠漆、木皮飾面板及特色玻璃鋪砌 (c) 不適用於23號洋房	
			b.	室內牆壁及天花板	客廳及飯廳裝修物料的類型
外露部份髹上乳膠漆。唯:- (a) 3號洋房外露部份鋪砌天然石材、不銹鋼板及捫布板 (b) 20號洋房客廳外露部份鋪砌天然石材、木皮飾面板、不銹鋼板及特色玻璃 (c) 20號洋房飯廳外露部份鋪砌木皮飾面板及鏡面 (d) 不適用於23號洋房	天花板外露部份髹乳膠漆，部份天花以石膏板假天花鋪砌及髹上乳膠漆。唯:- (a) 3號洋房天花板外露部份以石膏板髹上乳膠漆及不銹鋼鋪砌 (b) 20號洋房客廳的天花板外露部份以木皮飾面板鋪砌 (c) 20號洋房飯廳的天花板外露部份以木皮飾面板及鏡面鋪砌 (d) 不適用於23號洋房				
		睡房及套房裝修物料的類型	外露部份髹上乳膠漆。唯:- (a) 3號洋房主人睡房鋪砌天然石材、鏡面、不銹鋼板、牆紙、刺繡裝飾板及捫布板 (b) 3號洋房睡房鋪砌牆紙、鏡面及不銹鋼板 (c) 20號洋房髹上裝飾油漆、鋪砌不銹鋼板、鏡面及捫布板 (d) 不適用於23號洋房	天花板外露部份髹乳膠漆，部份天花以石膏板假天花鋪砌及髹上乳膠漆。唯:- (a) 3號洋房天花板外露部份以石膏板髹上乳膠漆、特色板及不銹鋼鋪砌 (b) 20號洋房天花板外露部份以石膏板髹上乳膠漆及鏡面鋪砌 (c) 不適用於23號洋房	



## FITTINGS, FINISHES AND APPLIANCES

### 裝置、裝修物料及設備

#### House

		Floor	Skirting	
c.	Internal floor	Material of Living Room & Dining Room	Engineered timber flooring with natural stone adjoining doors to gardens, except: - (a) House 3 are finished with natural stone with stainless steel (b) The Living Room of House 20 are finished with artificial stone and porcelain tiles (c) The Dining Room of House 20 are finished with natural stone (d) Not applicable for House 23	Timber skirting, except:- (a) House 3 and House 20 are finished with stainless steel skirting (b) Not applicable for House 23
		Material of Bedroom & Ensuite	Engineered timber flooring, natural stone border adjoining doors to balconies and flat roofs, except: - (a) Master Bedroom of House 3 are finished with natural stone and carpet (b) Master Bedroom, Ensuite 1 & 2 of House 20 are finished with porcelain tiles (c) Not applicable for House 23	Timber skirting, except:- (a) House 3 and House 20 are finished with stainless steel skirting (b) Not applicable for House 23
d.	Bathroom	Type of finishes	Wall	Exposed surface of wall are finished with ceramic tiles, natural stone, mirror and feature glass, except: - (a) For House 3, the exposed surface of bathrooms for Ensuites are finished with natural stone, except the master bathrooms are finished with natural stone and mosaic tile (b) The exposed surface of House 11 & 12 are finished with natural stone, mirror and featured glass (c) The exposed surface of bathrooms of House 20 are finished with natural stone (d) Not applicable for House 23
			Floor	Ceramic tiles to exposed surface except: - (a) The exposed surface of House 3, 11 & 12 are finished with natural stone (b) The exposed surface of House 20 are finished with ceramic tiles. (c) Not applicable for House 23
			Ceiling	Gypsum board false ceiling with emulsion paint to exposed surface, except:- (a) The exposed surface of House 3 are equipped with gypsum board false ceilings and feature panel with emulsion paint (b) Not applicable for House 23
		Whether the wall finishes run up to ceiling	Up to level of false ceiling except not applicable for House 23	

		Wall	Floor	
e.	Kitchen	Type of finishes	Exposed surface of wall are finished with feature glass, ceramic tiles and stainless steel panel, except: - (a) The exposed surface of House 11, 12 & 23 are finished with feature glass, natural stone and stainless steel panel (b) The exposed surface of House 3 are finished with natural stone (c) The exposed surface of House 20 are finished with feature glass, stainless steel panel and timber veneered surface panel	Natural stone
		Ceiling	Gypsum board false ceiling with emulsion paint to the exposed surface, except the exposed surface of House 3 are equipped with gypsum board false ceiling with stainless steel	Cooking Bench
		Whether the wall finishes run up to ceiling	Up to level of false ceiling	Solid surface

FITTINGS, FINISHES AND APPLIANCES

裝置、裝修物料及設備

c.	室內地板	客廳及飯廳的用料	地板 複合木地板，花園沿門之地台圍邊鋪砌天然石材。唯： (a) 3號洋房鋪砌天然石材配不銹鋼 (b) 20號洋房客廳鋪砌人造石材及瓷磚 (c) 20號洋房飯廳鋪砌天然石材 (d) 不適用於23號洋房	牆腳線 木牆腳線。唯： (a) 3號洋房及20號洋房鋪砌不銹鋼腳線 (b) 不適用於23號洋房
		睡房及套房的用料	複合木地板，露台及平台沿門之地台圍邊鋪砌天然石材。唯： (a) 3號洋房主人睡房鋪砌天然石材及地毯 (b) 20號洋房主人睡房、套房1及2鋪砌瓷磚 (c) 不適用於23號洋房	木牆腳線。唯： (a) 3號洋房及20號洋房鋪砌不銹鋼腳線 (b) 不適用於23號洋房
d.	浴室	裝修物料的類型	牆壁 外露牆身鋪砌瓷磚、天然石材、鏡面及特色玻璃。唯： (a) 3號洋房除主人浴室鋪砌天然石材及瓷磚外，套房浴室鋪砌天然石材 (b) 11及12洋房的外露牆身鋪砌天然石材、鏡面及特色玻璃 (c) 20號洋房浴室鋪砌天然石材 (d) 不適用於23號洋房	
			地板	天花板
			外露部份鋪砌瓷磚。唯： (a) 3、11及12洋房的外露牆身鋪砌天然石材 (b) 20號洋房的外露牆身鋪砌瓷磚 (c) 不適用於23號洋房	外露部份鋪砌石膏板假天花，塗上乳膠漆。唯： (a) 3號洋房的天花板外露部份以石膏板及特色板鋪砌，並髹上乳膠漆 (b) 不適用於23號洋房
		牆壁的裝修物料是否鋪至天花板	裝飾物料鋪至假天花。唯不適用於23號洋房	

e.	廚房	裝修物料的類型	牆壁 外露牆身鋪砌特色玻璃、瓷磚及不銹鋼板。唯： (a) 11、12及23號洋房的外露牆身鋪砌特色玻璃、天然石材及不銹鋼板 (b) 3號洋房的外露牆身鋪砌天然石材 (c) 20號洋房的外露牆身鋪砌特色玻璃、不銹鋼板及木皮飾面板	地板 天然石材
			天花板	灶台
			外露部份鋪砌石膏板假天花，髹上乳膠漆。唯3號洋房的外露牆身鋪砌石膏板假天花配不銹鋼	
		牆壁的裝修物料是否鋪至天花板	鋪至假天花底	

## FITTINGS, FINISHES AND APPLIANCES

### 裝置、裝修物料及設備

#### House

3. Interior Fittings	
Item	Description
	Material, Finishes and Accessories
	Main Entrance at B/F Solid core timber door finished with timber veneer and fitted with lockset, door viewer, door closer and door stopper
	Door adjacent to staircase at B/F Solid core timber door finished with timber veneer and glass vision panel and fitted with door closer and door stopper
	Door to Lift Lobby at B/F (for House 25, 26, 27 & 28 only) Solid core timber door finished with timber veneer and glass vision panel and fitted with door closer and door stopper
	Rain Door at G/F Entrance (except House 25 - 28) Rain Door at UG/F Entrance (for House 25 - 28 only) Aluminium framed glass door with PVF2 coating, fitted with lockset and door stopper
	Main Entrance at G/F (except House 25 - 28) Main Entrance at UG/F (for House 25 - 28 only) Solid core timber door finished with timber veneer and fitted with lockset, door viewer, door closer and door stopper, except: - (a) House 3 are equipped with steel framed door finished with copper panel and fitted with lockset, door viewer, door closer and door stopper (b) House 20 are equipped with steel framed door with feature glass, mirror panel and stainless steel panel, and fitted with lockset, door viewer, door closer and door stopper
	Door to B/F at G/F (for House 3 only) Hollow core timber door finished with mirror, and fitted with door stopper
	Dining Room at 1/F (for House 20 only) Solid core timber door finished with timber veneer, stainless steel panel & glass panel and fitted with lockset, door closer and door stopper
	Master Bedroom, Bedroom & Ensuite Hollow core timber door finished with timber veneer and fitted with lockset and door stopper, except: - (a) Ensuite 1 of House 20 are equipped with hollow core timber door finished with plastic laminate and lacquered surface and fitted with lockset
	Master Bathroom, Bathroom and Powder Room Hollow core timber door finished with timber veneer and fitted with lockset and door stopper, except: - (a) Timber louvre is provided for Master Bathrooms, Bathrooms and Powder Rooms in the following houses, - Master Bathroom 1 of House 1-2, 5-7, 11, 15-19, 21, 22, 25-28 - Master Bathroom 2 of House 1-2, 5-7, 11, 15-19, 21, 22, 23, 25-28 - Bathroom 1 of House 8-10 - Bathroom 2 of House 8-11 - Powder Room of all houses except House 3 & House 20 (b) The Master Bathrooms of House 3 are equipped with steel framed glass door (c) The Bathroom 1 & Powder Room of House 3 are equipped with hollow core timber door finished with timber veneer and fabric panel and fitted with lockset and door stopper (d) The Master Bathrooms of House 20 are equipped with glass door and fitted with lockset (e) The bathrooms and Powder Rooms of House 20 are equipped with hollow core timber door finished with timber veneer, lacquered surface and fitted with lockset

a.	Doors	Kitchen	Solid core timber door finished with timber veneer and glass vision panel and fitted with door lockset and door stopper, except: - (a) Kitchen of House 3 are equipped with steel framed glass door, and fitted with door lockset and door stopper (b) Kitchen of House 20 are equipped with steel door finished with timber veneer and mirror, and fitted with door lockset and door stopper
		Store Room	Hollow core timber door finished with timber veneer and fitted with lockset and door stopper, except: - (a) the store rooms of the following houses are equipped with hollow core timber door finished with timber veneer and featured glass, and fitted with lockset and door stopper - Store Room of House 8, 9 & 10 - Store Room 2 of House 1-2, 5-7, 11, 12, 15-19, 21 & 22 (b) Store Room 2 of House 3 at G/F are equipped with steel door finished with mirror, and fitted with lockset and door stopper (c) Store Room 1 of House 20 at B/F are equipped with hollow core timber door finished with timber veneer, lacquered surface and stainless steel
		Utility Room	Hollow core timber door finished with timber veneer and fitted with lockset and door stopper, except: - (a) the utility rooms of the following houses are equipped with hollow core timber door finished with timber veneer and featured glass, and fitted with lockset and door stopper - Utility Room of House 25-28 - Utility Room 2 & Utility Room 3 of House 23 (b) Utility Room of House 3 are equipped with hollow core timber door finished with timber veneer and fitted with door stopper (c) Utility Room of House 20 are equipped with hollow core timber door finished with timber veneer, lacquered surface and stainless steel
		Lavatory	Aluminium framed frosted glass door fitted with lockset
		Doors to garden, balcony, flat roof & roof	Aluminium framed glass door with PVF2 coating fitted with lockset and door stopper

洋房

3. 室內裝置		描述	
細項		描述	
a.	門		用料、裝修物料及配件
		地庫洋房入口	木皮飾面實心木門，裝設門鎖、防盜眼、門鼓及門檔
		地庫樓梯旁門	木皮飾面實心木門配玻璃視窗，裝設門鼓及門檔
		地庫門通往電梯大堂 (只供25-28號洋房)	木皮飾面實心木門配玻璃視窗，裝設門鎖及門檔
		地下防雨門 (除25至28號洋房外) 上層地下防雨門 (只供25至28號洋房)	氟炭噴塗鋁質框玻璃門，裝設門鎖及門檔
		地下單位入口 (除25至28號洋房外) 上層地下單位入口 (只供25至28號洋房)	木皮飾面實心木門，配門鎖、防盜眼、門鼓及門檔。唯:- (a) 3號洋房裝設銅飾面板鋼框門，裝設門鎖、防盜眼、門鼓及門檔 (b) 20號洋房裝設特色玻璃、鏡面及不銹鋼板飾面鋼框門，配門鎖、門鼓及門檔
		地下門通往地庫 (只供3號洋房)	鏡面及不銹鋼板飾面空心木門，裝設門檔
		1樓飯廳 (只供20號洋房)	木皮飾面、不銹鋼板實心木門，配門鎖、門鼓及門檔
		主人睡房、睡房及套房	木皮飾面空心木門，裝設門鎖及門檔。唯: (a) 20號洋房的套房1裝設烤漆及膠板飾面空心木門，配門鎖
		主人浴室、浴室及客廳洗手間	木皮飾面空心木門，配門鎖及門檔。唯: (a) 以下洋房之主人浴室、浴室及客廳洗手間門加設木百葉:- - 1至2、5至7、11、15至19、21、22、25至28號洋房的主人浴室1 - 1至2、5至7、11、15至19、21、22、23、25至28號洋房的主人浴室2 - 8至10號洋房的浴室1 - 8至11號洋房的浴室2 - 除3號洋房及20號洋房外，所有洋房的客廳洗手間 (b) 3號洋房的主人浴室裝設鋼框玻璃門 (c) 3號洋房浴室1及客廳洗手間裝設木皮飾面及捫布板飾面空心木門，配門鎖及門檔 (d) 20號洋房的主人浴室裝設玻璃門，配門鎖 (e) 20號洋房的浴室、客廳及飯廳洗手間裝設木皮飾面及烤漆飾面空心木門，配門鎖

a.	門	廚房	木皮飾面實心木門配玻璃視窗，配門鎖及門檔。唯: (a) 3號洋房的廚房裝設鋼框玻璃門，配門鎖及門檔 (b) 20號洋房的廚房裝設木皮飾面及鏡面鋼門，配門鎖及門檔
		儲物室	木皮飾面空心木門，裝設門鎖及門檔。唯: (a) 以下洋房之儲物室裝設木皮飾面及特色玻璃飾面空心木門，配門鎖及門檔: - 8、9及10號洋房的儲物室 - 1至2、5至7、11、12及15至19、21及22號洋房的儲物室2 (b) 地下3號洋房的儲物室2裝設鏡面鋼框門，配門鎖及門檔 (c) 地庫20號洋房的儲物室1裝設木皮飾面、烤漆飾面及不銹鋼飾面空心木門
		工作間	木皮飾面空心木門，配門鎖及門檔。唯: (a) 以下洋房之工作間門裝設木皮飾面及特色玻璃飾面空心木門，配門鎖及門檔: - 25至28號洋房的工作間 - 23號洋房的工作間2及工作間3 (b) 3號洋房的工作間裝設木皮飾面空心木門，裝設門檔 (c) 20號洋房的工作間裝設木皮飾面、烤漆飾面及不銹鋼飾面空心木門
		洗手間	鋁質框半透明玻璃門，裝設門鎖
		門通往花園、露台、平台及天台	氟炭噴塗鋁質框玻璃門，配門鎖及門檔



# FITTINGS, FINISHES AND APPLIANCES

## 裝置、裝修物料及設備

### House

		Fittings & Equipment		Type	Material
b.	Bathroom	(i) Type and material of fittings and equipment	Cabinet	Basin countertop	Natural stone except not applicable to House 23
				Basin cabinet	Wooden cabinet with plastic laminated finish, featured glass panel, except: - (a) Wooden cabinet with stainless steel surface panel is provided for the Master Bathroom 1 of House 3 (b) Wooden cabinet with natural stone surface is provided for the Master Bathroom 2 of House 3 (c) Steel cabinet with stainless steel surface panel and mirror panel is provided for the Bathroom 1 of House 3 (d) Wooden cabinet with leather surface panel is provided for the Bathroom 2 of House 3 (e) Wooden cabinet with lacquered surface panel is provided for the master bathrooms & bathrooms of House 20 (f) Not applicable for House 23
				Mirror cabinet	Wooden cabinet with plastic laminated finish, mirror panel and featured glass panel, except: - (a) Wooden cabinet finished with mirror and stainless steel is provided for master bathrooms and Bathroom 1 of House 3 (b) Wooden cabinet finished with mirror and stainless steel and alabaster is provided for Bathroom 2 of House 3 (c) Steel cabinet finished with mirror is provided for master bathrooms and bathrooms of House 20 (d) Not applicable for House 23
			Bathroom fittings and equipment	Wash basin mixer	Chrome plated, except wash basin mixer with copper plated is provided for Master Bathroom 2 of House 1-3, 5-12, 15-19, 21, 22 & 25-28
				Water closet	Vitreous china
				Wash basin	Vitreous china, except natural stone wash basin for Master Bathroom 2 of House 3
				Shower set	Chrome plated, except shower set with copper plated is provided for Master Bathroom 2 of House 1-2, 5-12, 15-19, 21, 22 & 25-28

b.	Bathroom	(i) Type and material of fittings and equipment	Bathroom fittings and equipment	Shower compartment	Clear tempered glass
				Towel bar	Chrome plated, except:- (a) towel bar with copper plated is provided for Bathroom 1 of House 3 and Master Bathroom 2 of House 1-3, 5-12, 15-19, 21 & 22, 25-28 (b) Not applicable for House 23
				Paper holder	Chrome plated paper holder for all master bedrooms, except: - (a) Paper holder with copper plated for Master Bathroom 2 of House 1-2, 5-12, 15-19, 21, 22, 25-28 (b) Stainless steel paper holder for Master Bathroom 1 of House 1-2, 5-12, 23, 25-28 (c) Stainless steel paper holder for all bathrooms except House 3 and House 20 (d) Not applicable for House 3, House 20 and House 23
				Robe hook	Chrome plated except: - (a) Robe hook with copper plated is provided for Master Bathroom 2 of House 1-2, 5-12, 15-19, 21-22 (b) Not applicable for House 3, House 20 and House 23
				Adjustable mirror	Chrome plated except:- (a) Adjustable mirror with copper plated is provided for Master Bathroom 2 of House 11, 12 & 15-19, 21-22 (b) Not applicable for House 1-3, 5-10, 20, 23, 25-28
		(ii) Type and material of water supply system	Type	Material	
			Cold water supply	Copper water pipes	
		(iii) Type and material of bathing facilities (including shower or bathtub, if applicable)	Hot water supply	Copper water pipes with thermal insulation	
			Shower set	Chrome plated, except shower set with copper plated is provided for Master Bathroom 2 of House 1-2, 5-12, 15-19, 21, 22 & 25-28	
			Shower compartment	Clear tempered glass except not applicable for House 23	
(iv) Size of bathtub	Bathtub	Enameled cast iron except polymarble bathtub is provided for Master Bathroom 1 of House 3 and Master Bathroom 2 of House 11 and House 12			
	please refer to the "Table for the size of bathtub" below				

#### Notes:

- Other than those parts of the conduits concealed within concrete, the rest of them are exposed. The exposed conduits may be covered or hidden by false ceilings, bulkheads, cabinets, claddings, non-concrete partition walls, designated pipe ducts or other materials.
- Other than those parts of the water pipes concealed within concrete, the rest of them are exposed. The exposed water pipes may be covered or hidden by false ceilings, bulkheads, cabinets, claddings, non-concrete partition walls, designated pipe ducts or other materials.



洋房

		裝置及設備		類型	用料
b.	浴室	(i) 裝置及設備的類型及用料	櫃 浴室裝置及設備	洗手盆檯面	天然石材。唯不適用於23號洋房
				洗手盆櫃	膠板及特色玻璃飾面面板木製櫃。 唯： (a) 3號洋房的主人浴室1裝設不銹鋼飾面面板木製櫃 (b) 3號洋房的主人浴室2裝設天然石材飾面木製櫃 (c) 3號洋房的浴室1裝設不銹鋼飾面及鏡面面板鋼製櫃 (d) 3號洋房的浴室2裝設真皮飾面面板木製櫃 (e) 20號洋房的主人浴室及浴室裝設烤漆飾面面板木製櫃 (f) 不適用於23號洋房
				鏡櫃	膠板、鏡面板及特色玻璃飾面木製櫃。唯： (a) 3號洋房的主人浴室及浴室1裝設鏡面及不銹鋼飾面木製櫃 (b) 3號洋房的浴室2裝設鏡面、不銹鋼及仿石透光板飾面木製櫃 (c) 20號洋房的主人浴室及浴室裝設鏡面鋼製櫃 (d) 不適用於23號洋房
				洗手盆水龍頭	鍍鉻。唯1至3、5至12, 15至19, 21, 22及25至28號洋房的主人浴室2裝設鍍銅的洗手盆水龍頭
				坐廁	陶瓷
				洗手盆	陶瓷。唯3號洋房的浴室裝設天然石材洗手盆
				花灑套裝	鍍鉻。唯1至2、5至12及15至19、21、22及25至28號洋房的主人浴室2裝設鍍銅的花灑套裝

b.	浴室	(i) 裝置及設備的類型及用料	浴室裝置及設備	淋浴間	透明強化玻璃
				毛巾棍	鍍鉻。唯： (a) 3號洋房的浴室1、1至3、5至12、15至19、21及22、25至28號洋房的主人浴室2裝設鍍銅的毛巾棍 (b) 不適用於23號洋房
				廁紙架	所有主人浴室裝設鍍鉻廁紙架。唯： (a) 1至2、5至12、15至19、21、22及25至28號洋房的主人浴室2裝設鍍銅的廁紙架 (b) 1至2、5至12、23及25至28號洋房的主人浴室1裝設不銹鋼廁紙架 (c) 除3號洋房及20號洋房外，所有浴室裝設不銹鋼廁紙架 (d) 不適用於3號洋房、20號洋房及23號洋房
				掛勾	鍍鉻，唯： (a) 1至2、5至12、15至19、21及22號洋房的主人浴室2裝設鍍銅的掛勾 (b) 不適用於3號洋房、20號洋房及23號洋房
				可調整鏡	鍍鉻，唯： (a) 11、12、15至19、21及22號洋房的主人浴室2裝設鍍銅的可調整鏡 (b) 不適用於1至3、5至10、20、23及25至28號洋房
			類型	用料	
			(ii) 供水系統的類型及用料	冷水供應	銅喉
				熱水供應	配有隔熱絕緣保護之銅喉
			(iii) 沐浴設施(包括花灑或浴缸，如適用)	花灑套裝	鍍鉻。唯1至2、5至12及15至19、21、22及25至28號洋房的主人浴室2裝設鍍銅的花灑套裝
				淋浴間	透明強化玻璃。唯不適用於23號洋房
		浴缸	瓷釉鑄鐵，唯3號洋房的主人浴室1、11及12號洋房的主人浴室2裝設人造石浴缸		
	(iv) 浴缸大小	請參閱「有關浴缸尺寸之列表」			

備註：

- 除部分隱藏於混凝土內之導管外，其他部分的導管均為外露。外露的導管可能被假天花、假陣、貯存櫃、覆面、非混凝土間牆、指定之槽位或其他物料遮蓋。
- 除部分隱藏於混凝土內之水管外，其他部分的水管均為外露。外露的水管可能被假天花、假陣、貯存櫃、覆面、非混凝土間牆、指定之槽位或其他物料遮蓋。

## FITTINGS, FINISHES AND APPLIANCES

### 裝置、裝修物料及設備

#### House

c.	Kitchen		Material		
		(i) Material of sink unit	Stainless steel		
		(ii) Material of water supply system	Copper water pipes for cold water supply and copper water pipes with thermal insulation for hot water supply		
			Material	Finishes	
		(iii) Material and finishes of kitchen cabinet	Wooden cabinet fitted with wooden cabinet door panel	Glossy lacquered surface door panel and glossy glass surface door panel are equipped with solid surface worktop except the kitchen cabinet of House 20 are equipped with lacquered surface door panel and timber veneer surface panel with solid surface worktop	
	(iv) Type of all other fittings and equipment	Chrome plated sink mixer			
d.	Bedroom		Fittings	Type	Material
		Type of fittings (Including built-in wardrobe)	Not applicable	Not applicable	Not applicable
e.	Telephone	Location and number of connection points	Telephone connection points are provided for living rooms, dining rooms, master bedrooms and ensuite. For location and number of connection points, please refer to the "Schedule of Mechanical & Electrical Provisions".		
f.	Aerials	Location and number of connection points	TV/FM outlets for local TV/FM radio programmers are provided in living rooms, dining rooms, kitchen, master bedroom, master bathrooms and bedrooms. For location and number of connection points, please refer to the "Schedule of Mechanical & Electrical Provisions".		
g.	Electrical installations	(i) Electrical fittings (including safety devices)	Electrical fittings	Faceplate for all switches and power sockets	
			Safety devices	Three phases electricity supply with miniature circuit breaker distribution	
		(ii) Whether conduits are concealed or exposed	Conduits are partly concealed and partly exposed <sup>1</sup>		
		(iii) Location and number of power points and air-conditioner points	Please refer to the "Schedule of Mechanical & Electrical Provisions"		

h.	Gas supply		Fittings
		Type	Towngas
		System	Gas supply pipe is provided and connected to gas cooking hob and gas water heater
		Location	For the location of gas connection points, please refer to the "Schedule of Mechanical & Electrical Provisions"
i.	Washing machine connection point	Location and Design	For the location and design of drain point and water point, please refer to the "Schedule of Mechanical & Electrical Provisions"
j.	Water supply	Material of water pipes	Copper water pipes are provided for cold water supply and copper water pipes with thermal insulation are provided for hot water supply
		Whether water pipes are concealed or exposed	Water pipes are partly concealed and partly exposed <sup>2</sup>
		Whether hot water is available	Hot water supply to all master bathrooms, bathrooms, guest powder rooms, lavatories and kitchen

#### Notes:

- Other than those parts of the conduits concealed within concrete, the rest of them are exposed. The exposed conduits may be covered or hidden by false ceilings, bulkheads, cabinets, claddings, non-concrete partition walls, designated pipe ducts or other materials.
- Other than those parts of the water pipes concealed within concrete, the rest of them are exposed. The exposed water pipes may be covered or hidden by false ceilings, bulkheads, cabinets, claddings, non-concrete partition walls, designated pipe ducts or other materials.

## FITTINGS, FINISHES AND APPLIANCES

### 裝置、裝修物料及設備

#### 洋房

		用料			
c.	廚房	(i) 洗滌盆的用料	不銹鋼		
		(ii) 供水系統的用料	冷水喉採用銅喉及熱水喉採用配有隔熱絕緣保護之銅喉		
			用料	裝修物料	
		(iii) 廚櫃	木製廚櫃體及櫃門板	高光烤漆櫃門和高光玻璃櫃門，配人造實心面板檯面，唯20號洋房的廚櫃配烤漆櫃門、木皮飾面櫃門及人造實心面板檯面	
	(iv) 所有其他裝置及設備的類型	鍍鉻水龍頭			
d.	睡房		裝置	類型	用料
		裝置 (包括嵌入式衣櫃) 的類型及用料	不適用	不適用	不適用
e.	電話	接駁點的位置及數目	客廳、飯廳、主人睡房及套房設有電話插座，有關接駁點的位置及數量請參考「機電裝置位置及數量說明表」		
f.	天線	接駁點的位置及數目	客廳、飯廳、廚房、主人睡房、套房及主人浴室均裝設有可接收本地電視節目及電台節目的電視 / 收音機天線插座，有關接駁點的位置及數量請參考「機電裝置位置及數量說明表」		
g.	電力裝置	(i) 供電附件 (包括安全裝置)	供電附件	提供電制及插座之面板	
			安全裝置	三相電力配電箱並裝置漏電斷路器	
		(ii) 導管是隱藏或外露	導管是部分隱藏及部分外露 <sup>1</sup>		
	(iii) 電插座及空調機接駁點的位置及數目	請參閱「機電裝置位置及數量說明表」			

		裝置	
h.	氣體供應	類型	煤氣
		系統	提供煤氣喉接駁煤氣煮食爐及煤氣熱水爐
		位置	煤氣接駁點的位置請參閱「機電裝置位置及數量說明表」
i.	洗衣機接駁點	位置及設計	有關配備來水及去水接駁點的位置及設計，請參閱「機電裝置位置及數量說明表」
j.	供水	水管的用料	冷水喉採用銅喉及熱水喉採用配有隔熱絕緣保護之銅喉
		水管是隱藏或外露	水管是部分隱藏及部分外露 <sup>2</sup>
		有否熱水供應	所有主人浴室、浴室、客廳洗手間、洗手間及廚房均有熱水供應

#### 備註：

- 除部分隱藏於混凝土內之導管外，其他部分的導管均為外露。外露的導管可能被假天花、假陣、貯存櫃、覆面、非混凝土間牆、指定之槽位或其他物料遮蓋。
- 除部分隱藏於混凝土內之水管外，其他部分的水管均為外露。外露的水管可能被假天花、假陣、貯存櫃、覆面、非混凝土間牆、指定之槽位或其他物料遮蓋。

## FITTINGS, FINISHES AND APPLIANCES

### 裝置、裝修物料及設備

#### House

4. Miscellaneous					
Item		Description			
		Residential lift			
a.	Lifts	(i) Brand name and model number	Brand Name	KONE	
			Model Number	MONOSPACE MX6 (For House 1-3, 5-7, 11, 15-22 & 25-28 only) MONOSPACE MX10 (For House 12 & 23)	
		(ii) Number and floors served by them	Number of lifts	A lift is provided for each house except House 8-10	
			Floor served by the lifts	B/F, G/F to 2/F (For House 1-3, 5-7, 11, 12, 15-23 only) B/F, UG/F, 1/F-2/F (For House 25-28 only)	
b.	Letter box	Material	Metal letter box		
c.	Refuse collection	(i) Means of refuse collection	Refuse will be collected by cleaners and handle at refuse storage and material recovery chamber		
		(ii) Location of refuse room	A refuse storage and material recovery chamber with vehicular access is provided at common area on B/F for collection of refuse		
d.	Water meter, electricity meter and gas meter		Water meter	Electricity meter	Gas meter
		(i) Location	Inside water meter cabinet for individual house	Inside electricity meter cabinet for individual house	Inside kitchen cabinet (For House 1-3, 5-10, 15-22, 25, 26 & 28 only) Inside cabinet adjacent to entrance gate (For House 27 only)
		(ii) Whether they are separate or communal meters for residential properties	Separate meter	Separate meter	Separate meter

5. Security Facilities		
Security system and equipment	Access control system and residential security system	Visitor intercom panel with smart card reader is provided at Development main entrance. Smart card reader is provided at carpark entrance. Motion sensors, security window & door contacts and glass break detectors are provided for G/F of each house. Security alarm signal will be transmitted to caretaker's office
	Video door phone and panic alarm system	Video door phone system with panic alarm button is provided at G/F entrance of each house connecting to video door phone of the house. Panic alarm button is provided for each master bedroom. All panic alarm buttons are connected to caretaker's office.
	Development perimeter security system & CCTV	CCTV cameras are provided at Development main entrance, common landscape area, recreational facilities, driveway, carpark entrance, carpark and replacement access along site perimeter. Perimeter infrared sensors are provided at replacement access along site perimeter. Both system are connected to caretaker's office.

6. Appliances	
Item	Description
Appliances	For brand names and provision of appliance provided, please refer to the "Appliances Schedule"

The vendor undertakes that if lifts or appliances of the specified brand name or model number are not installed in the Development, lifts or appliances of comparable quality will be installed.



## FITTINGS, FINISHES AND APPLIANCES

### 裝置、裝修物料及設備

#### 洋房

4. 雜項					
細項		描述			
		住宅升降機			
a.	升降機	(i) 品牌名稱及產品型號	品牌名稱	通力	
			產品型號	MONOSPACE MX6 (只適用於1至3、5至7、11、15至22及25至28號洋房) MONOSPACE MX10 (只適用於12及23號洋房)	
		(ii) 升降機的數目及到達的樓層	升降機的數目	除8至10號洋房外，各洋房均設有一部升降機。	
			到達的樓層	地庫、地下至2樓 (只適用於1至3、5至7、11、12及15至23號洋房) 地庫、上層地下、1樓及2樓 (只適用於25至28號洋房)	
b.	信箱	用料	金屬信箱		
c.	垃圾收集	(i) 垃圾收集的方法	由清潔工人收集垃圾並於垃圾及物料回收室收集處理		
		(ii) 垃圾房的位置	一個有車輛通道公用垃圾儲存及物料回收房設於地庫之公用地方，以作垃圾收集處理		
d.	水錶、電錶及氣體錶		水錶	電錶	氣體錶
		(i) 位置	安裝於各洋房水錶箱內	安裝於各洋房電錶箱內	安裝於廚櫃內(只適用於1至3、5至10、15至22、25、26及28號洋房) 安裝於正門欄旁的箱內(只適用於27號洋房)
		(ii) 就住宅單位而言是獨立或公用的錶	獨立錶	獨立錶	獨立錶

5. 保安設施		
細項		描述
保安系統及設備	通道控制及保安系統	訪客視象對講系統及智能卡出入系統裝設於屋苑主入口，智能卡出入系統設於停車場入口。洋房地下設有動態感應器、窗戶及出入門之磁力感應器、玻璃破碎感應器，警報訊號均會傳送至管理員辦事處
	視像對講機及警報按鈕系統	各洋房地下入口裝有訪客視像對講機並連接該洋房內之視像對講機連警報按鈕。各洋房內主人睡房均設有求救警報按鈕。所有求救警報按鈕均連接管理員辦事處。
	屋苑邊界保安系統及閉路電視	屋苑主入口、公共園景區、康樂設施、車輛通道、停車場入口、停車場及屋苑邊界公共行人通道裝有閉路電視系統；屋苑邊界公共行人通道裝有紅外線感應器；邊界紅外線感應系統和閉路電視系統均連接管理員辦事處。

6. 裝置	
細項	
裝置	有關裝置和設備的品牌及產品型號，請參閱「裝置說明表」

賣方承諾如該項目中沒有安裝指明的品牌名稱或產品型號的升降機或設備，便會安裝品質相若的升降機或設備。

## FITTINGS, FINISHES AND APPLIANCES

### 裝置、裝修物料及設備

#### Tower

1. Exterior Finishes			
Item		Description	
a.	External wall	Type of finishes	Curtain wall, aluminium cladding, stone cladding, aluminium grilles, artificial granite tiles
b.	Window	Material of frame	PVF2 aluminium window frame
		Material of glass	Clear tempered glass and grey tinted glass
c.	Bay window	Material of bay window	Not applicable
		Finishes of window sill	Not applicable
d.	Planter	Type of finishes	Not applicable
e.	Verandah or balcony	Type of finishes	Balcony : Fitted with clear tempered glass balustrade with aluminium handrail
			Floor : Homogeneous floor tiles
			Wall : Aluminium cladding
			Ceiling : Emulsion paint to exposed surface
		Whether it is covered	Balcony is covered
	Verandah	Not applicable	
f.	Drying facilities for clothing	Type	Not applicable
		Material	Not applicable

2. Interior Finishes				
Item		Description		
a.	Lobby	Type of finishes of Residential Entrance Lobby on B/F	Wall	
			Natural stone, decorative mirror and stainless steel panel to exposed surface	
			Floor	Ceiling
			Natural stone	Gypsum board with mirror panel false ceiling
		Type of finishes of Residential Entrance Lobby on G/F	Wall	
			Natural stone, decorative mirror, wood veneer and stainless steel panel to exposed surface	
			Floor	Ceiling
			Natural stone	Gypsum board with mirror panel and stainless steel false ceiling
		Type of finishes of each floor common lift lobby	Wall	
			Unglazed porcelain tiles and stainless steel panel to exposed surface	
			Floor	Ceiling
			Unglazed porcelain tiles, natural stone and reconstituted stone	Gypsum board false ceiling
Type of finishes of each floor private lift lobby	Wall			
	Decorative mirror and stainless steel to exposed surface, except the exposed surface of Flat B on 9/F of Tower 8 are finished with solid surface panel and stainless steel, some areas are finished with emulsion paint			
	Floor	Ceiling		
	Porcelain tiles and natural stone, except the Flat B on 9/F of Tower 8 are finished with natural stone	Gypsum board false ceiling with emulsion paint, decorative mirror and stainless steel, except: - (a) The exposed surface of ceilings of Flat B on 9/F of Tower 8 are finished with stainless steel		

#### Note:

• “Terrace Apartment”, “Garden Apartment” and “Courtyard Penthouse” are names for marketing purposes only and will not appear in any Deed of Mutual Covenant, the Preliminary Agreement for Sale and Purchase, Agreement for Sale and Purchase, Assignment, or any other title deeds and documents relating to the Development. The names as appearing on the approved building plans are: Flat A on 1/F of Tower 1 for Terrace Apartment on 1/F of Tower 1; Flat B on G/F of Tower 2 for Garden Apartment on G/F of Tower 2; Flat B on G/F of Tower 3 for Garden Apartment on G/F of Tower 3; Flat A on G/F of Tower 7 for Garden Apartment on G/F of Tower 7; Penthouse on 11/F of Tower 7 for Courtyard Penthouse on 11/F of Tower 7; Flat B on G/F of Tower 8 for Garden Apartment on G/F of Tower 8; Penthouse on 11/F of Tower 8 for Courtyard Penthouse on 11/F of Tower 8.

## FITTINGS, FINISHES AND APPLIANCES

### 裝置、裝修物料及設備

#### 大樓

1. 外部裝修物料			
細項		描述	
a.	外牆	裝修物料的類型	玻璃幕牆、鋁質飾板、天然石材飾板、鋁質格柵及仿石磚
b.	窗	框的用料	氟碳噴塗鋁窗框
		玻璃的用料	透明強化玻璃及灰色玻璃
c.	窗台	窗台的用料	不適用
		窗台板的裝修物料	不適用
d.	花槽	裝修物料的類型	不適用
e.	陽台或露台	裝修物料的類型	露台：裝有透明強化玻璃欄配以鋁質扶手
			地台：同心透底地磚
			牆身：鋁質飾板
			天花：天花外露部份髹上乳膠漆
		是否有蓋	露台有蓋
	陽台	不適用	
f.	乾衣設施	類型	不適用
		用料	不適用

2. 室內裝修物料				
細項		描述		
a.	大堂	地下一層住宅入口穿越升降機大堂裝修物料的類型	牆壁	
			外露部份鋪砌天然石材、鏡面裝飾及不銹鋼板	
			地板	天花板
			天然石材	石膏板配鏡面板假天花
		地面層住宅入口穿越升降機大堂裝修物料的類型	牆壁	
			外露部份鋪砌天然石材、裝飾鏡面、木皮飾面及不銹鋼板	
			地板	天花板
			天然石材	石膏板配鏡面板及不銹鋼假天花
		各層升降機公共大堂裝修物料的類型	牆壁	
			外露部份鋪砌無釉瓷磚及不銹鋼板	
			地板	天花板
			無釉瓷磚、天然石材及人造石材	石膏板假天花
各層升降機私人大堂裝修物料的類型	牆壁			
	外露部份鋪砌鏡面裝飾及不銹鋼。唯第8座9樓B單位鋪砌實心人造石板及不銹鋼，部份牆身髹上乳膠漆			
	地板	天花板		
	瓷磚、天然石材。唯第8座9樓B單位鋪砌天然石材	石膏板假天花髹上乳膠漆，配鏡面裝飾及不銹鋼。唯第8座9樓B單位的天花板外露部份以不銹鋼鋪砌		

#### 備註：

• 「Terrace Apartment」、「Garden Apartment」及「Courtyard Penthouse」僅為市場推廣之用的名稱，並不會於關於發展項目的任何公契、臨時買賣合約、買賣合約、轉讓契及契據出現。經批准的建築圖則上顯示的名稱為：第1座1樓A單位（即第1座1樓Terrace Apartment）；第2座地下B單位（即第2座地下Garden Apartment）；第3座地下B單位（即第3座地下Garden Apartment）；第7座地下A單位（即第7座地下Garden Apartment）；第7座11樓Penthouse（即第7座11樓Courtyard Penthouse）；第8座地下B單位（即第8座地下Garden Apartment）；第8座11樓Penthouse（即第8座11樓Courtyard Penthouse）。

## FITTINGS, FINISHES AND APPLIANCES

### 裝置、裝修物料及設備

#### Tower

		Wall	Ceiling
b.	Internal wall and ceiling	Type of Living and Dining Room finishes	Emulsion paint to exposed surface, except: - (a) The exposed surface of Flat B on 7/F of Tower 2 and Flat B on 8/F of Tower 2 are finished with natural stones, featured glass, mirror and featured panel (b) The exposed surface of Flat B on 9/F of Tower 8 are finished with solid surface panel, mirror, lacquered surface panel, stainless steel, some areas are finished with emulsion paint
		Ensuite and Bedroom finishes	Emulsion paint to exposed surface, except: - (a) The exposed surface of Flat B on 7/F of Tower 2 and Flat B on 8/F of Tower 2 are finished with natural stones, mirror, fabric panel and stainless steel
c.	Internal floor	Material of Living Room and Dining Room	Floor Engineered timber flooring, natural stone boarder adjoining doors to gardens and flat roofs: - (a) Flat B on 7/F of Tower 2 and Flat B on 8/F of Tower 2 are finished with artificial stone (b) Flat B on 9/F of Tower 8 are finished with artificial stone
		Material of Ensuite and Bedroom	Skirting Timber skirting except: - (a) Flat B on 7/F of Tower 2 and Flat B on 8/F of Tower 2 are equipped with stainless steel skirting (b) Flat B on 9/F of Tower 8 are equipped with solid surface skirting.
		Material of Living Room and Dining Room	Skirting Timber skirting except :- (a) Flat B on 7/F of Tower 2 and Flat B on 8/F of Tower 2 are equipped with stainless steel skirting (b) Flat B on 9/F of Tower 8 are equipped with solid surface skirting

		Wall	Ceiling
d.	Bathroom	Type of finishes	Exposed surface of ceilings are finished with emulsion paint, some areas are equipped with gypsum board false ceiling with emulsion paint, except: - (a) The exposed surface of ceilings of Flat B on 7/F of Tower 2 and Flat B on 8/F of Tower 2 are finished with emulsion paint, some areas are equipped with gypsum board false ceilings with emulsion paint and feature panel (b) The exposed surface of ceilings of Flat B on 9/F of Tower 8 are equipped with gypsum board false ceilings with emulsion paint and stainless steel
		Whether the wall finishes run up to ceiling	Up to level of false ceiling
e.	Kitchen	Type of finishes	Ceramic tiles, natural stone and featured glass to the exposed surface except:- (a) Flat B on 7/F of Tower 2 and Flat B on 8/F of Tower 2, the exposed surface of Bathroom 1 & 3 are finished with porcelain tiles, the exposed surface of Bathroom 2 are finished with porcelain tiles, natural stone, stainless steel, feature glass; The exposed surface of Master Bathroom are finished with natural stone  (b) The exposed surface of Flat B on 9/F of Tower 8 are finished with artificial stone
		Whether the wall finishes run up to ceiling	Up to level of false ceiling
		Material of Living Room and Dining Room	Skirting Timber skirting except :- (a) Flat B on 7/F of Tower 2 and Flat B on 8/F of Tower 2 are equipped with stainless steel skirting (b) Flat B on 9/F of Tower 8 are equipped with solid surface skirting

#### Note:

• “Terrace Apartment”, “Garden Apartment” and “Courtyard Penthouse” are names for marketing purposes only and will not appear in any Deed of Mutual Covenant, the Preliminary Agreement for Sale and Purchase, Agreement for Sale and Purchase, Assignment, or any other title deeds and documents relating to the Development. The names as appearing on the approved building plans are: Flat A on 1/F of Tower 1 for Terrace Apartment on 1/F of Tower 1; Flat B on G/F of Tower 2 for Garden Apartment on G/F of Tower 2; Flat B on G/F of Tower 3 for Garden Apartment on G/F of Tower 3; Flat A on G/F of Tower 7 for Garden Apartment on G/F of Tower 7; Penthouse on 11/F of Tower 7 for Courtyard Penthouse on 11/F of Tower 7; Flat B on G/F of Tower 8 for Garden Apartment on G/F of Tower 8; Penthouse on 11/F of Tower 8 for Courtyard Penthouse on 11/F of Tower 8.



## FITTINGS, FINISHES AND APPLIANCES

### 裝置、裝修物料及設備

#### 大樓

			牆壁	天花板
			b. 室內牆壁及天花板	客廳及飯廳裝修物料的类型
		套房及睡房裝修物料的类型	外露部份髹上乳膠漆。唯:- (a) 第2座7樓B單位及第2座8樓B單位的外露部份鋪砌天然石材、鏡面、捫布板、特色板及不銹鋼	天花板外露部份髹乳膠漆，部份天花以石膏板鋪砌及髹上乳膠漆
c. 室內地板			地板	牆腳線
		客廳及飯廳的用料	複合木地板，連接花園及平台沿門之地台鋪砌天然石材。唯:- (a) 第2座7樓B單位及第2座8樓B單位鋪砌瓷磚 (b) 第8座9樓B單位鋪砌人造石	木牆腳線。唯:- 第2座7樓B單位及第2座8樓B單位鋪砌不銹鋼腳線 (b) 第8座9樓B單位鋪砌實心人造石腳線
		套房睡房的用料	複合木地板，連接花園、露台、工作平台及平台沿門之地台鋪砌天然石材。唯:- (a) 第2座7樓B單位及第2座8樓B單位鋪砌瓷磚 (b) 第8座9樓B單位鋪砌人造石	木牆腳線。唯:- (a) 第2座7樓B單位及第2座8樓B單位鋪砌不銹鋼腳線 (b) 第8座9樓B單位鋪砌實心人造石腳線

			牆壁		
			d. 浴室	裝修物料的类型	外露部份鋪砌瓷磚、天然石材及特色玻璃。唯:- (a) 第2座7樓B單位及第2座8樓B單位浴室1及3鋪砌瓷磚，浴室2鋪砌瓷磚、天然石材、不銹鋼及特色玻璃，主人浴室鋪砌天然石材 (b) 第8座9樓B單位鋪砌人造石
		套房及睡房裝修物料的类型	石膏板假天花髹上乳膠漆。唯:- (a) 第2座7樓B單位及第2座8樓B單位浴室1及3天花板外露部份以石膏板假天花髹上乳膠漆、鏡面、不銹鋼及特色玻璃鋪砌 (b) 第2座7樓B單位及第2座8樓B單位浴室2及主人浴室鋪砌天然石材 (c) 第8座9樓B單位鋪砌人造石	外露部份鋪砌瓷磚。唯:- (a) 第2座7樓B單位及第2座8樓B單位浴室1及3鋪砌瓷磚 (b) 第2座7樓B單位及第2座8樓B單位浴室2及主人浴室鋪砌天然石材 (c) 第8座9樓B單位鋪砌人造石	石膏板假天花髹上乳膠漆。唯:- (a) 第2座7樓B單位及第2座8樓B單位浴室1及3天花板外露部份以石膏板假天花髹上乳膠漆、鏡面、不銹鋼及特色玻璃鋪砌 (b) 第2座7樓B單位及第2座8樓B單位浴室2及主人浴室鋪砌天然石材 (c) 第8座9樓B單位鋪砌人造石
		牆壁的裝修物料是否鋪至天花板	鋪至假天花底		
e. 廚房		裝修物料的类型	牆壁	地板	
			外露牆身鋪砌特色玻璃、瓷磚及不銹鋼板。唯第8座9樓B單位鋪砌玻璃及烤漆面板	外露牆身鋪砌瓷磚。唯第8座9樓B單位鋪砌人造石	
			天花板	灶台	
			外露部份以石膏板髹上乳膠漆及不銹鋼鋪砌	實心人造石	
		牆壁的裝修物料是否鋪至天花板	鋪至假天花底		

#### 備註：

• 「Terrace Apartment」、「Garden Apartment」及「Courtyard Penthouse」僅為市場推廣之用的名稱，並不會於關於發展項目的任何公契、臨時買賣合約、買賣合約、轉讓契及契據出現。經批准的建築圖則上顯示的名稱為：第1座1樓A單位（即第1座1樓Terrace Apartment）；第2座地下B單位（即第2座地下Garden Apartment）；第3座地下B單位（即第3座地下Garden Apartment）；第7座地下A單位（即第7座地下Garden Apartment）；第7座11樓Penthouse（即第7座11樓Courtyard Penthouse）；第8座地下B單位（即第8座地下Garden Apartment）；第8座11樓Penthouse（即第8座11樓Courtyard Penthouse）。



## FITTINGS, FINISHES AND APPLIANCES

### 裝置、裝修物料及設備

#### Tower

3. Interior Fittings			
Item	Description		
			Material, Finishes and Accessories
a.	Doors	Entrance	Solid core timber door finished with timber veneer and fitted with lockset, door viewer, door closer and door stopper, except:- (a) Flat B on 7/F of Tower 2 and Flat B on 8/F of Tower 2 are equipped with stainless steel framed glass door (b) Flat B on 9/F of Tower 8 are equipped with stainless steel framed glass door and fitted with door lock
		Master Bedroom, Bedroom, Ensuite & Study Room	Hollow core timber door finished with timber veneer and fitted with lockset and door stopper, except:- (a) The Master Bedroom of Flat B on 7/F of Tower 2 and Flat B on 8/F of Tower 2 are equipped with hollow core timber door finished with feature panel and fitted with lockset and door closer (b) The Ensuite 1 of Flat B on 7/F of Tower 2 and Flat B on 8/F of Tower 2 are equipped with hollow core timber door finished with feature panel and fitted with lockset and door closer (c) The Ensuite 2 of Flat B on 7/F of Tower 2 and Flat B on 8/F of Tower 2 are equipped with hollow core timber door finished with feature panel and mirror and fitted with lockset and door closer (d) The Master Bedroom and Bedroom 1 of Flat B on 9/F of Tower 8 are equipped with hollow core timber door finished with lacquered surface and fitted with lockset, door closer and door stopper (e) The Ensuite of Flat B on 9/F of Tower 8 are equipped with hollow core timber door finished with lacquered surface and solid surface and fitted with lockset, door closer and door stopper
		Store Room	Hollow core timber door finished with timber veneer and fitted with lockset and door stopper, except:- (a) The store rooms of the following residential units are equipped with hollow core sliding timber door finished with timber veneer and fitted with lockset and stopper:- <u>Store Room</u> - Spa Duplex A & B on 11/F of Tower 2 <u>Store Room 1</u> - Sky Pool Penthouse on 11/F of Tower 1 & Tower 3 <u>Store Room 2</u> - Garden Duplex on G/F-1/F of Tower 2 - • Garden Apartment on G/F of Tower 3 <u>Store Room 3</u> - Garden Duplex on G/F-1/F of Tower 1 & Tower 3 (b) The store rooms of the following residential units are equipped with hollow core timber door finished with plastic laminated and feature glass and fitted with lockset and stopper:- <u>Store Room 1</u> - Garden Duplex on G/F-1/F of Tower 1 - Tower 3 (c) The store rooms of the following residential units are equipped with steel door finished with artificial granite tiles and fitted with lockset:- <u>Store Room</u> - Sky Pool Penthouse in 11/F of Tower 5 & Tower 6 - • Courtyard Penthouse on 11/F of Tower 7 & Tower 8 <u>Store Room 2</u> - Sky Pool Penthouse in 11/F of Tower 1 & Tower 3

a.	Doors	Bathroom	Hollow core timber door finished with timber veneer and fitted with lockset and door stopper, except: - (a) Timber louvre is provided for bathrooms, powder rooms in the following residential units: - <u>Bathroom 1</u> - Garden Duplex on G/F-1/F of Tower 1 & Tower 3 - • Garden Apartment on G/F of Tower 3 - • Terrace Apartment on 1/F of Tower 1 - Flat B on 1/F of Tower 3 - Flat A & B on 2/F, 3/F, 5/F-10/F of Tower 1 & Tower 3 - Sky Pool Penthouse on 11/F of Tower 1 & Tower 3 - Flat A on 2/F-3/F, 5/F-9/F of Tower 2 - Flat B on 1/F-3/F, 5/F-6/F & 9/F of Tower 2 - Flat A & B on 1/F-3/F, 5/F-10/F of Tower 5, Tower 6 & Tower 7 - Flat A & B on 1/F-3/F, 5/F-8/F & 10/F of Tower 8, Flat A on 9/F of Tower 8 - • Garden Apartment on G/F of Tower 7 & Tower 8 <u>Bathroom 2</u> - • Terrace Apartment at 1/F of Tower 1 - Flat B at 1/F of Tower 3 - Flat A & B on 2/F, 3/F, 5/F-10/F of Tower 1 & Tower 3 - • Garden Apartment on G/F at Tower 2 - Garden Duplex on G/F - 1/F at Tower 2 - Flat A & B on 1/F-3/F, 5/F-10/F of Tower 5 & Tower 6 <u>Bathroom 3</u> - Garden Duplex on G/F-1/F of Tower 1 - • Garden Apartment on G/F of Tower 2 & Tower 3 - Garden Duplex on G/F-1/F of Tower 2 & Tower 3 - Flat A on 2/F-3/F, 5/F-9/F of Tower 2 - Flat B on 1/F-3/F, 5/F-6/F & 9/F of Tower 2 - Spa Duplex A & Spa Duplex B on 11/F of Tower 2 (b) The master bathrooms of the following residential units are equipped with aluminium framed glass door and fitted with lockset and door stopper: - <u>Master Bathroom</u> - Garden Duplex on G/F-1/F of Tower 2 - Spa Duplex A and B on 11/F of Tower 2 - Sky Pool Penthouse on 11/F of Tower 5 & Tower 6 - • Courtyard Penthouse on 11/F of Tower 7 & Tower 8 (c) The Bathroom 1 & 3 of Flat B on 7/F of Tower 2 and Flat B on 8/F of Tower 2 are equipped with hollow core door with feature panel and timber veneered, and fitted with lockset and door stopper (d) The Master Bathroom and Bathroom 2 of Flat B on 7/F of Tower 2 and Flat B on 8/F of Tower 2 are equipped with glass door (e) The Master Bathroom and Bathrooms of Flat B on 9/F of Tower 8 are equipped with hollow core door with lacquered surface
		Back Door (Entrance from common lobbies)	Solid core timber door finished with timber veneer and fitted with lockset, door viewer, door closer and door stopper, except: - (a) Flat B on 9/F of Tower 8 are equipped with solid core timber door finished with lacquered surface and timber veneer, fitted with lockset, door viewer, door closer and door stopper

#### Note:

• “Terrace Apartment”, “Garden Apartment” and “Courtyard Penthouse” are names for marketing purposes only and will not appear in any Deed of Mutual Covenant, the Preliminary Agreement for Sale and Purchase, Agreement for Sale and Purchase, Assignment, or any other title deeds and documents relating to the Development. The names as appearing on the approved building plans are: Flat A on 1/F of Tower 1 for Terrace Apartment on 1/F of Tower 1; Flat B on G/F of Tower 2 for Garden Apartment on G/F of Tower 2; Flat B on G/F of Tower 3 for Garden Apartment on G/F of Tower 3; Flat A on G/F of Tower 7 for Garden Apartment on G/F of Tower 7; Penthouse on 11/F of Tower 7 for Courtyard Penthouse on 11/F of Tower 7; Flat B on G/F of Tower 8 for Garden Apartment on G/F of Tower 8; Penthouse on 11/F of Tower 8 for Courtyard Penthouse on 11/F of Tower 8.

## FITTINGS, FINISHES AND APPLIANCES

### 裝置、裝修物料及設備

#### 大樓

3. 室內裝置			
細項	描述		
			用料、裝修物料及配件
a.	門	單位入口	木皮飾面實心木門，配門鎖、防盜眼、門鼓及門檔。唯:- (a) 第2座7樓B單位及第2座8樓B單位裝設不銹鋼框玻璃門 (b) 第8座9樓B單位裝設不銹鋼框玻璃門，配門鎖
		主人睡房、睡房、套房及書房	木皮飾面實心木門，配門鎖及門檔。唯： (a) 第2座7樓B單位及第2座8樓B單位主人房裝設特色板空心木門，配門鎖及門鼓 (b) 第2座7樓B單位及第2座8樓B單位套房1裝設特色板及木皮飾面空心木門，配門鎖及門鼓 (c) 第2座7樓B單位及第2座8樓B單位套房2裝設特色板及鏡面飾面空心木門，配門鎖及門鼓 (d) 第8座9樓B單位主人睡房及睡房1裝設烤漆飾面空心木門，配門鎖、門鼓及門檔 (e) 第8座9樓B單位套房裝設烤漆面及人造石飾面空心木門，配門鎖、門鼓及門檔
		儲物室	空心木門，木皮飾面空心木門，配門鎖及門檔。唯:- (a) 以下住宅單位之儲物室門配木皮飾面空心趟木門，裝設門鎖及門檔:- 儲物室 - 第2座10樓至11樓 Spa Duplex A and Spa Duplex B 儲物室1 - 第1座及第3座11樓 Sky Pool Penthouse 儲物室2 - 第2座地下至1樓花園 Garden Duplex - 第3座地下· Garden Apartment 儲物室3 - 第1座及第3座地下至1樓 Garden Duplex (b) 以下住宅單位之儲物室的空心木門配膠板及特色玻璃飾面，裝設門鎖及門檔:- 儲物室1 - 第1座至第3座地下至1樓 Garden Duplex (c) 以下住宅單位之儲物室裝設仿石磚飾面鐵門，配門鎖:- 儲物室 - 第5座及第6座11樓 Sky Pool Penthouse - 第7座及第8座11樓· Courtyard Penthouse 儲物室2 - 第1座及第3座11樓 Sky Pool Penthouse

a.	門	浴室	木皮飾面空心木門，配門鎖及門檔，唯:- (a)以下住宅單位之浴室及客廳洗手間門加設木百頁:- 浴室1 - 第1座及第3座地下至1樓Garden Duplex - 第3座地下· Garden Apartment - 第1座1樓· Terrace Apartment - 第3座1樓B單位 - 第1座及第3座2樓、3樓、5樓至10樓A及B單位 - 第1座及第3座11樓Sky Pool Penthouse - 第2座2樓、3樓、5樓至9樓A單位 - 第2座1樓至3樓、5樓至6樓及9樓B單位 - 第5座、第6座及第7座1樓至3樓、5樓至10樓A及B單位 - 第8座1樓至3樓、5樓至8樓及10樓A及B單位，第8座9樓A單位 - 第7座及第8座地下· Garden Apartment 浴室2 - 第1座1樓· Terrace Apartment - 第3座1樓B單位 - 第1座及第3座2樓、3樓、5樓至10樓A及B單位 - 第2座地下· Garden Apartment - 第2座地下至1樓Garden Duplex - 第5座及第6座1樓至3樓、5樓至10樓A及B單位 浴室3 - 第1座地下至1樓Garden Duplex - 第2座及第3座地下· Garden Apartment - 第2座及第3座地下至1樓Garden Duplex - 第2座2樓、3樓、5樓至9樓A單位 - 第2座1樓至3樓、5樓至6樓及9樓B單位 - 第2座11樓Spa Duplex A及Spa Duplex B (b)以下住宅單位之主人浴室門裝設鋁質框玻璃門，配門鎖及門檔:- 主人浴室 - 第2座地下至1樓花園 Garden Duplex - 第2座11樓 Spa Duplex A and B - 第5座及第6座11樓 Sky Pool Penthouse - 第7座及第8座11樓· Courtyard Penthouse (c) 第2座7樓B單位及第2座8樓B單位浴室1及浴室3裝設特色板及木皮飾面空心木門，配門鎖及門鼓 (d) 第2座7樓B單位及第2座8樓B單位主人浴室及浴室2裝設玻璃門 (e) 第8座9樓B單位主人浴室及浴室裝設烤漆飾面空心木門
		後門(連接公共大堂)	木皮飾面實心木門，配門鎖、防盜眼、門鼓及門檔。唯:- (a) 第8座9樓B單位裝設烤漆飾面及木皮飾面實心木門，配門鎖、防盜眼、門鼓及門檔

#### 備註：

• 「Terrace Apartment」、「Garden Apartment」及「Courtyard Penthouse」僅為市場推廣之用的名稱，並不會於關於發展項目的任何公契、臨時買賣合約、買賣合約、轉讓契及契據出現。經批准的建築圖則上顯示的名稱為：第1座1樓A單位（即第1座1樓Terrace Apartment）；第2座地下B單位（即第2座地下Garden Apartment）；第3座地下B單位（即第3座地下Garden Apartment）；第7座地下A單位（即第7座地下Garden Apartment）；第7座11樓Penthouse（即第7座11樓Courtyard Penthouse）；第8座地下B單位（即第8座地下Garden Apartment）；第8座11樓Penthouse（即第8座11樓Courtyard Penthouse）。

**FITTINGS, FINISHES AND APPLIANCES**

**裝置、裝修物料及設備**

**Tower**

a	Doors	Kitchen	Solid core timber door finished with timber veneer and glass vision and fitted with door closer, lockset and door stopper, except: - (a) Flat B on 7/F of Tower 2 and Flat B on 8/F of Tower 2 are equipped with solid core timber door finished with feature panel and timber veneer, and fitted with door closer (b) Flat B on 9/F of Tower 8 are equipped with solid core timber door finished with lacquered surface, and fitted with glass vision, door closer and door stopper
		Powder Room	Hollow core timber door finished with timber veneer and fitted with timber louvers, lockset and door stopper, except: - (a) Timber louvre is provided for powder rooms in the following residential units: - - Garden Duplex on G/F-1/F of Tower 1, Tower 2 & Tower 3 - • Garden Apartment on G/F of Tower 3 - Flat B on 1/F of Tower 2 - Flat A on 2/F, 3/F, 5/F-9/F of Tower 2 - Flat B on 2/F, 3/F, 5/F-6/F & 9/F of Tower 2 - Spa Duplex A & Spa Duplex B on 10/F-11/F of Tower 2 - Sky Pool Penthouse on 11/F of Tower 5 & Tower 6 - • Courtyard Penthouse on 11/F of Tower 7 & Tower 8 (b) Flat B on 8/F of Tower 2 are equipped with hollow core timber door finished with feature panel (c) Flat B on 9/F of Tower 8 are equipped with hollow core timber door finished with solid surface and lacquered surface, fitted with lockset and door stopper
		Lavatory	Aluminium framed frosted glass door fitted with lockset and door stopper, except: - (a) Timber louvre is provided for lavatories in the following residential units: - - Garden Duplex on G/F-1/F of Tower 2 - Spa Duplex A & Spa Duplex B on 10/F-11/F of Tower 2
		Utility Room	Hollow core timber door finished with plastic laminate, feature glass panel and stainless steel panel and fitted with lockset and door stopper, except:- (a) Flat B on 9/F of Tower 8 are equipped with hollow core timber door finished with lacquered surface and fitted with door closer, lockset and door stopper.
		Doors to Balconies, Utility Platforms, Gardens and Flat Roofs	Aluminium framed glass door finished with PVF2 coating fitted with lockset and door stopper

**Note:**

• “Terrace Apartment”, “Garden Apartment” and “Courtyard Penthouse” are names for marketing purposes only and will not appear in any Deed of Mutual Covenant, the Preliminary Agreement for Sale and Purchase, Agreement for Sale and Purchase, Assignment, or any other title deeds and documents relating to the Development. The names as appearing on the approved building plans are: Flat A on 1/F of Tower 1 for Terrace Apartment on 1/F of Tower 1; Flat B on G/F of Tower 2 for Garden Apartment on G/F of Tower 2; Flat B on G/F of Tower 3 for Garden Apartment on G/F of Tower 3; Flat A on G/F of Tower 7 for Garden Apartment on G/F of Tower 7; Penthouse on 11/F of Tower 7 for Courtyard Penthouse on 11/F of Tower 7; Flat B on G/F of Tower 8 for Garden Apartment on G/F of Tower 8; Penthouse on 11/F of Tower 8 for Courtyard Penthouse on 11/F of Tower 8.

## FITTINGS, FINISHES AND APPLIANCES

### 裝置、裝修物料及設備

#### 大樓

a.	門	廚房	木皮飾面實心木門配玻璃視窗，裝設門鼓、門鎖及門檔。唯： (a) 第2座7樓B單位及第2座8樓B單位裝設特色板及木皮飾面實心木門，配門鼓 (b) 第8座9樓B單位裝設烤漆飾面實心門，配玻璃視窗、門鼓及門檔
		客廳洗手間	木皮飾面空心木門，設有木百頁，配門鎖及門檔。唯： (a) 以下住宅單位之主人浴室、浴室及客廳洗手間門加設木百頁： - 第1座、第2座及第3座地下至1樓Garden Duplex - 第3座地下· Garden Apartment - 第2座1樓B單位 - 第2座2樓、3樓、5樓至9樓A單位 - 第2座2樓、3樓、5樓至6樓及9樓B單位 - 第2座10樓至11樓Spa Duplex A及Spa Duplex B - 第5座及第6座11樓Sky Pool Penthouse - 第7座及第8座11樓· Courtyard Penthouse (b) 第2座8樓B單位裝設特色板飾面空心木門 (c) 第8座9樓B單位裝設人造石面及烤漆面飾面空心木門，配門鎖及門檔
		洗手間	鋁質框半透明玻璃門，裝設門鎖及門檔。唯： (a) 以下住宅單位之洗手間門加設木百頁： - 第2座地下至1樓Garden Duplex - 第2座10樓至11樓Spa Duplex A及Spa Duplex B
		工作間	空心木門，配膠板、特色玻璃板及不銹鋼板飾面，裝設木百頁，配門鎖及門檔。唯： (a) 第8座9樓B單位裝設烤漆面飾面空心木門，配門鼓、門鎖及門檔
		通往露台、工作平台、花園及平台門	氟炭噴塗鋁質框玻璃門，裝設門鎖及門檔

#### 備註：

• 「Terrace Apartment」、「Garden Apartment」及「Courtyard Penthouse」僅為市場推廣之用的名稱，並不會於關於發展項目的任何公契、臨時買賣合約、買賣合約、轉讓契及契據出現。經批准的建築圖則上顯示的名稱為：第1座1樓A單位（即第1座1樓Terrace Apartment）；第2座地下B單位（即第2座地下Garden Apartment）；第3座地下B單位（即第3座地下Garden Apartment）；第7座地下A單位（即第7座地下Garden Apartment）；第7座11樓Penthouse（即第7座11樓Courtyard Penthouse）；第8座地下B單位（即第8座地下Garden Apartment）；第8座11樓Penthouse（即第8座11樓Courtyard Penthouse）。



**FITTINGS, FINISHES AND APPLIANCES**

**裝置、裝修物料及設備**

Tower					
				Type	Material
b.	Bathroom	(i) Type and material of fittings and equipment	Cabinets	Basin countertop	Natural stone, except solid surface countertop for Flat B on 9/F of Tower 8
				Basin cabinet	Wooden cabinet with plastic laminate and featured glass panels, except:-  (a) Flat B on 7/F of Tower 2 and Flat B on 8/F of Tower 2 are equipped with wooden cabinet with plastic laminate, stainless steel and glossy lacquered surface panels (b) Flat B on 9/F of Tower 8 are equipped with wooden cabinet with fiberglass panel
				Mirror cabinet	Wooden cabinet with plastic laminate, mirror panels, glass and alabaster, except:-  (a) Flat B on 7/F of Tower 2 and Flat B on 8/F of Tower 2 are equipped with wooden cabinet with plastic laminate, stainless steel (b) Flat B on 9/F of Tower 8 are equipped with wooden cabinet with fiberglass panel
			Bathroom fittings and equipment	Wash basin mixer	Chrome plated except wash basin mixer with copper plated (PVD) for the master bathrooms of the following residential units:- - Garden Duplex on G/F-1/F of Tower 1, Tower 2 and Tower 3 - Sky Pool Penthouse on 11/F of Tower 1, Tower 3, Tower 5 and Tower 6 - • Garden Apartment on G/F of Tower 2 and Tower 3 - Spa Duplex A and B on 10/F-11/F of Tower 2 - • Garden Apartment on G/F of Tower 7 and Tower 8 - • Courtyard Penthouse on 11/F of Tower 7 and Tower 8
				Water closet	Vitreous china
				Wash basin	Vitreous china, except:- (a) Master Bathroom of Flat B on 7/F of Tower 2 and Flat B on 8/F of Tower 2 are equipped with natural stone wash basin (b) Master Bathroom and bathrooms of Flat B on 9/F of Tower 8 are equipped with solid surface wash basin

b.	Bathroom	(i) Type and material of fittings and equipment	Bathroom fittings and equipment	Towel bar	Chrome plated, except:- (a) Towel bar with copper plated for the master bathrooms of the following residential units - Garden Duplex on G/F-1/F of Tower 1, Tower 2 and Tower 3 - Sky Pool Penthouse on 11/F of Tower 1, Tower 3, Tower 5 and Tower 6 - • Garden Apartment on G/F of Tower 2 and Tower 3 - Spa Duplex A and Spa Duplex B on 10/F-11/F of Tower 2 - • Garden Apartment on G/F of Tower 7 and Tower 8 - • Courtyard Penthouse on 11/F of Tower 7 & Tower 8 (b) Copper plated towel bar for the Master Bathroom of Flat B on 7/F of Tower 2 and Flat B on 8/F of Tower 2
				Adjustable mirror	Chrome plated, except:- (a) Adjustable mirror with copper plated for the master bathrooms of the following residential units - Garden Duplex on G/F-1/F of Tower 1, Tower 2 and Tower 3 - Sky Pool Penthouse on 11/F of Tower 1, Tower 3, Tower 5 and Tower 6 - • Garden Apartment on G/F of Tower 2 and Tower 3 - Spa Duplex A and Spa Duplex B on 10/F-11/f of Tower 2 - • Garden Apartment on G/F of Tower 7 and Tower 8 - • Courtyard Penthouse on 11/F of Tower 7 and Tower 8 (b) Not applicable for Flat B on 7/F of Tower 2 and Flat B on 8/F of Tower 2 and Flat B on 9/F of Tower 8

**Note:**

• “Terrace Apartment”, “Garden Apartment” and “Courtyard Penthouse” are names for marketing purposes only and will not appear in any Deed of Mutual Covenant, the Preliminary Agreement for Sale and Purchase, Agreement for Sale and Purchase, Assignment, or any other title deeds and documents relating to the Development. The names as appearing on the approved building plans are: Flat A on 1/F of Tower 1 for Terrace Apartment on 1/F of Tower 1; Flat B on G/F of Tower 2 for Garden Apartment on G/F of Tower 2; Flat B on G/F of Tower 3 for Garden Apartment on G/F of Tower 3; Flat A on G/F of Tower 7 for Garden Apartment on G/F of Tower 7; Penthouse on 11/F of Tower 7 for Courtyard Penthouse on 11/F of Tower 7; Flat B on G/F of Tower 8 for Garden Apartment on G/F of Tower 8; Penthouse on 11/F of Tower 8 for Courtyard Penthouse on 11/F of Tower 8.

FITTINGS, FINISHES AND APPLIANCES

裝置、裝修物料及設備

大樓

		裝置及設備		類型	用料
b	浴室	(i) 裝置及設備的類型及用料	櫃	洗手盆檯面	天然石材。唯第8座9樓B單位配人造石面檯面。
				洗手盆櫃	膠板及特色玻璃板飾面木製櫃。唯： (a) 第2座7樓B單位及第2座8樓B單位配膠板，不銹鋼及高光烤漆飾面木製櫃 (b) 第8座9樓B單位配玻璃纖維板飾面木製櫃
				鏡櫃	膠板、鏡面板、玻璃及仿石透光板飾面木製櫃。唯： (a) 第2座7樓B單位及第2座8樓B單位配膠板，不銹鋼飾面木製櫃 (b) 第8座9樓B單位配玻璃纖維板木製櫃
		浴室裝置及設備	洗手盆水龍頭	鍍鉻，唯 以下住宅單位的主人浴室內裝鍍銅 (PVD處理)可調整鏡： - 第1座、第2座及第3座地下至1樓Garden Duplex - 第1座、第3座、第5座及第6座11樓 Sky Pool Penthouse - 第2座及第3座地下 • Garden Apartment - 第2座10樓至11樓Spa Duplex A及Spa Duplex B - 第7座及第8座地下 • Garden Apartment - 第7座及第8座11樓 • Courtyard Penthouse	
			坐廁	搪瓷	
			洗手盆	搪瓷。唯:- (a) 第2座7樓B單位及第2座8樓B單位主人浴室配天然石材洗手盆 (b) 第8座9樓B單位主人浴室、浴室及客廳洗手間配人造實心洗手盆	

		(i) 裝置及設備的類型及用料	浴室裝置及設備	毛巾棍	鍍鉻，唯:- (a) 以下住宅單位的主人浴室內裝鍍銅 以下住宅單位的主人浴室內裝鍍銅毛巾棍： - 第1座、第2座及第3座地下至1樓 Garden Duplex - 第1座、第3座、第5座及第6座11樓 Sky Pool Penthouse - 第2座及第3座地下 • Garden Apartment - 第2座10樓至11樓Spa Duplex A及Spa Duplex B - 第7座及第8座地下 • Garden Apartment - 第7座及第8座11樓 • Courtyard Penthouse (b) 第2座7樓B單位及第2座8樓B單位主人浴室配鍍銅毛巾棍
				可調整鏡	鍍鉻，唯:- (a) 以下住宅單位的主人浴室內裝鍍銅可調整鏡： - 第1座、第2座及第3座地下至1樓Garden Duplex - 第1座、第3座、第5座及第6座11樓Sky Pool Penthouse - 第2座及第3座地下 • Garden Apartment - 第2座10樓至11樓Spa Duplex A及Spa Duplex B - 第7座及第8座地下 • Garden Apartment - 第7座及第8座11樓 • Courtyard Penthouse (b)不適用於第2座7樓B單位及第2座8樓B單位及第8座9樓B單位

備註：

• 「Terrace Apartment」、「Garden Apartment」及「Courtyard Penthouse」僅為市場推廣之用的名稱，並不會於關於發展項目的任何公契、臨時買賣合約、買賣合約、轉讓契及契據出現。經批准的建築圖則上顯示的名稱為：第1座1樓A單位（即第1座1樓Terrace Apartment）；第2座地下B單位（即第2座地下Garden Apartment）；第3座地下B單位（即第3座地下Garden Apartment）；第7座地下A單位（即第7座地下Garden Apartment）；第7座11樓Penthouse（即第7座11樓Courtyard Penthouse）；第8座地下B單位（即第8座地下Garden Apartment）；第8座11樓Penthouse（即第8座11樓Courtyard Penthouse）。

**FITTINGS, FINISHES AND APPLIANCES**

**裝置、裝修物料及設備**

b	Bathroom	(i) Type and material of fittings and equipment	Bathroom fittings and equipment	Paper holder	Chrome plated, except:- (a) Paper holder with copper plated for the master bathrooms of the following residential units - Garden Duplex on G/F-1/F of Tower 1, Tower 2 and Tower 3 - Sky Pool Penthouse on 11/F of Tower 1, Tower 3, Tower 5 and Tower 6 - • Garden Apartment on G/F of Tower 2 and Tower 3 - Spa Duplex A and Spa Duplex B on 10/F-11/f of Tower 2 - • Garden Apartment on G/F of Tower 7 and Tower 8 - • Courtyard Penthouse on 11/F of Tower 7 and Tower 8 (b) Not applicable for Flat B on 7/F of Tower 2 and Flat B on 8/F of Tower 2	
				Robe hook	Chrome plated, except:- (a) Robe hook with copper plated for the master bathrooms of the following residential units - Garden Duplex on G/F-1/F of Tower 1, Tower 2 and Tower 3 - Sky Pool Penthouse on 11/F of Tower 1, Tower 3, Tower 5 and Tower 6 - • Garden Apartment on G/F of Tower 2 and Tower 3 - Spa Duplex A and Spa Duplex B on 10/F-11/f of Tower 2 - • Garden Apartment on G/F of Tower 7 and Tower 8 - • Courtyard Penthouse on 11/F of Tower 7 and Tower 8 (b) Not applicable for Flat B on 7/F of Tower 2 and Flat B on 8/F of Tower 2 and Flat B on 9/F of Tower 8	
		(ii) Type and material of water supply system		Cold water supply	Copper water pipes	
				Hot water supply	Copper water pipes with thermal insulation	
		(iii) Type and material of bathing facilities (including shower or bath tub, if applicable)		Material, Finishes and Accessories		
				Shower set	Chrome plated, except:- (a) Shower set with copper plated for all master bathrooms except for Flat B on 7/F of Tower 2 and Flat B on 8/F of Tower 2 and Flat B on 9/F of Tower 8	
				Bathtub	Enamelled cast iron, except: (a) The bathtub of the Master bathroom for Flat B on 7/F of Tower 2 and Flat B on 8/F of Tower 2 are finished with polymarble (b) The bathtub of the Master bathroom & bathrooms for Flat B on 9/F of Tower 8 are finished with acrylic	
		(iv) Size of bathtub or Shower		Material, size & location		
				please refer to the "Bathroom Schedule"		

**Note:**

• "Terrace Apartment", "Garden Apartment" and "Courtyard Penthouse" are names for marketing purposes only and will not appear in any Deed of Mutual Covenant, the Preliminary Agreement for Sale and Purchase, Agreement for Sale and Purchase, Assignment, or any other title deeds and documents relating to the Development. The names as appearing on the approved building plans are: Flat A on 1/F of Tower 1 for Terrace Apartment on 1/F of Tower 1; Flat B on G/F of Tower 2 for Garden Apartment on G/F of Tower 2; Flat B on G/F of Tower 3 for Garden Apartment on G/F of Tower 3; Flat A on G/F of Tower 7 for Garden Apartment on G/F of Tower 7; Penthouse on 11/F of Tower 7 for Courtyard Penthouse on 11/F of Tower 7; Flat B on G/F of Tower 8 for Garden Apartment on G/F of Tower 8; Penthouse on 11/F of Tower 8 for Courtyard Penthouse on 11/F of Tower 8.

## FITTINGS, FINISHES AND APPLIANCES

### 裝置、裝修物料及設備

b	浴室	(i) 裝置及設備的類型及用料	浴室裝置及設備	廁紙架	鍍鉻，唯： (a) 以下住宅單位的主人浴室內裝鍍銅廁紙架： -第1座、第2座及第3座地下至1樓 Garden Duplex -第1座、第3座、第5座及第6座11樓 Sky Pool Penthouse -第2座及第3座地下・ Garden Apartment -第2座10樓至 11樓Spa Duplex A及 Spa Duplex B -第7座及第8座地下・ Garden Apartment -第7座及第8座11樓・ Courtyard Penthouse (b) 不適用於第2座7樓B單位及第2座8樓B單位
				毛巾勾	鍍鉻，唯:- (a) 以下住宅單位的主人浴室內裝鍍銅毛巾勾： -第1座、第2座及第3座地下至1樓 Garden Duplex -第1座、第3座、第5座及第6座11樓 Sky Pool Penthouse -第2座及第3座地下・ Garden Apartment -第2座10樓至11樓Spa Duplex A及 Spa Duplex B -第7座及第8座地下・ Garden Apartment -第7座及第8座11樓・ Courtyard Penthouse (b) 不適用於第2座7樓B單位及第2座8樓B單位及第8座9樓B單位
		(ii) 供水系統的類型及用料	冷水供應	銅喉	
			熱水供應	配有隔熱絕緣保護之銅喉	
		(iii) 沐浴設施(包括花灑或浴缸，如適用)	花灑套裝	鍍鉻，唯:- (a) 除第2座7樓B單位及第2座8樓B單位及第8座9樓B單位外，所有主人浴室內裝鍍銅花灑套裝	
			浴缸	瓷釉鑄鐵。唯： (a) 第2座7樓B單位及第2座8樓B單位主人浴室配人造石浴缸 (b) 第8座9樓B單位主人浴室配壓克力浴缸	
			用料、尺寸及位置		
		(iv) 浴缸大小	請參閱「浴室說明表」		

#### 備註：

• 「Terrace Apartment」、「Garden Apartment」及「Courtyard Penthouse」僅為市場推廣之用的名稱，並不會於關於發展項目的任何公契、臨時買賣合約、買賣合約、轉讓契及契據出現。經批准的建築圖則上顯示的名稱為：第1座1樓A單位（即第1座1樓Terrace Apartment）；第2座地下B單位（即第2座地下Garden Apartment）；第3座地下B單位（即第3座地下Garden Apartment）；第7座地下A單位（即第7座地下Garden Apartment）；第7座11樓Penthouse（即第7座11樓Courtyard Penthouse）；第8座地下B單位（即第8座地下Garden Apartment）；第8座11樓Penthouse（即第8座11樓Courtyard Penthouse）。



## FITTINGS, FINISHES AND APPLIANCES

### 裝置、裝修物料及設備

#### Tower

		Material		
c.	Kitchen	(i) Materials of sink unit	Stainless steel	
		(ii) Material of water supply system	Copper water pipes for cold water supply and copper water pipes with thermal insulation for hot water supply	
			Material	Finishes
		(iii) Materials and finishes of kitchen cabinet	Wooden cabinet fitted with wooden cabinet door panel	Glossy lacquered surface door panel and plastic laminate door panel, are equipped with solid surface worktop, except:- (a) the kitchen cabinet of following residential units are finished with glossy lacquered surface door panel and equipped with solid surface worktop:- - Garden Duplex on G/F-1/F of Tower 1, Tower 2 and Tower 3 - Sky Pool Penthouse on 11/F of Tower 1, Tower 3, Tower 5 and Tower 6 - • Garden Apartment on G/F of Tower 2 and Tower 3 - Spa Duplex A and Spa Duplex B on 10/F-11/f of Tower 2 - • Garden Apartment on G/F of Tower 7 and Tower 8 - • Courtyard Penthouse on 11/F of Tower 7 and Tower 8 - Flat B on 9/F of Tower 8
	(iv) Type of all other fittings and equipment	Chrome plated sink mixer		

#### Notes:

- Other than those parts of the conduits concealed within concrete, the rest of them are exposed. The exposed conduits may be covered or hidden by false ceilings, bulkheads, cabinets, claddings, non-concrete partition walls, designated pipe ducts or other materials.
- Other than those parts of the water pipes concealed within concrete, the rest of them are exposed. The exposed water pipes may be covered or hidden by false ceilings, bulkheads, cabinets, claddings, non-concrete partition walls, designated pipe ducts or other materials.
- “Terrace Apartment”, “Garden Apartment” and “Courtyard Penthouse” are names for marketing purposes only and will not appear in any Deed of Mutual Covenant, the Preliminary Agreement for Sale and Purchase, Agreement for Sale and Purchase, Assignment, or any other title deeds and documents relating to the Development. The names as appearing on the approved building plans are: Flat A on 1/F of Tower 1 for Terrace Apartment on 1/F of Tower 1; Flat B on G/F of Tower 2 for Garden Apartment on G/F of Tower 2; Flat B on G/F of Tower 3 for Garden Apartment on G/F of Tower 3; Flat A on G/F of Tower 7 for Garden Apartment on G/F of Tower 7; Penthouse on 11/F of Tower 7 for Courtyard Penthouse on 11/F of Tower 7; Flat B on G/F of Tower 8 for Garden Apartment on G/F of Tower 8; Penthouse on 11/F of Tower 8 for Courtyard Penthouse on 11/F of Tower 8.

		Fittings	Type	Material	
d.	Bedroom	Type of fittings (Including built-in wardrobe)	Not applicable	Not applicable	Not applicable
e.	Telephone	Location and number of connection points	Telephone connection points are provided for living rooms, dining rooms, master bedrooms, bedrooms and ensuite. For location and number of connection points, please refer to the "Schedule of Mechanical & Electrical Provisions"		
f.	Aerials	Location and number of connection points	TV/FM outlets for local TV/FM radio programmes are provided in living rooms, dining rooms, kitchen, master bedrooms, bedrooms, ensuite and master bathrooms. For location and number of connection points, please refer to the "Schedule of Mechanical & Electrical Provisions"		
g.	Electrical installations	(i) Electrical fittings (including safety devices)	Electrical fittings	Faceplate for all switches and power sockets	
			Safety devices	Three phases electricity supply with miniature circuit breaker distribution boards completed with residual-current device	
		(ii) Whether conduits are concealed or exposed	Whether conduits are concealed or exposed		
		(iii) Location and number of power points and air conditioner points	Please refer to the "Schedule of Mechanical & Electrical Provisions"		
h.	Gas supply		Fittings		
		Type	Towngas		
		System	Gas supply pipe is provided and connected to gas cooking hob and gas water heater		
	Location	For the location of gas connection points, please refer to the "Schedule of Mechanical & Electrical Provisions"			
i.	Washing machine connection point	Location and Design	For the location and design of drain point and water point, please refer to the "Schedule of Mechanical & Electrical Provisions"		
j.	Water supply	Material of water pipes	Copper water pipes are provided for cold water supply and copper water pipes with thermal insulation are provided for hot water supply		
		Whether water pipes are concealed or exposed	Water pipes are partly concealed and partly exposed <sup>2</sup>		
		Whether hot water is available	Hot water supply to all master bathrooms, bathrooms, powder rooms, lavatories and kitchens		

## FITTINGS, FINISHES AND APPLIANCES

### 裝置、裝修物料及設備

#### 大樓

		用料	
c. 廚房	(i) 洗滌盆的用料	不銹鋼	
	(ii) 供水系統的用料	冷水喉採用銅喉及熱水喉採用配有隔熱絕緣保護之銅喉	
		用料	裝修物料
	(iii) 廚櫃的用料及裝修物料	木製廚櫃及木櫃門板	高光烤漆面櫃門板和膠板櫃門板並配有實心人造石檯面，唯:- (a) 以下住宅單位的廚房廚櫃由高光烤漆面櫃門板組成，並配有實心人造面板檯面 - 第1座、第2座及第3座地下至1樓Garden Duplex - 第1座、第3座、第5座及第6座11樓Sky Pool Penthouse - 第2座及第3座地下 • Garden Apartment - 第2座10樓至11樓Spa Duplex A及Spa Duplex B - 第7座及第8座地下 • Garden Apartment - 第7座及第8座11樓 • Courtyard Penthouse - 第8座9樓B單位
(iv) 所有其他裝置及設備的類型	鍍鉻水龍頭		

		裝置	類型	用料
d.	睡房	裝置 (包括嵌入式衣櫃) 的類型及用料	不適用	不適用
e.	電話	接駁點的位置及數目	客廳、飯廳、主人睡房、睡房及套房設有電話插座，有關接駁點的位置及數量請參考「機電裝置位置及數量說明表」	
f.	天線	接駁點的位置及數目	客廳、飯廳、主人睡房、睡房及套房設有電話插座，有關接駁點的位置及數量請參考「機電裝置位置及數量說明表」	
g.	電力裝置	(i) 供電附件(包括安全裝置)	供電附件	提供電制及插座之面板
			安全裝置	三相電力配電箱並裝置漏電斷路器
		(ii) 導管是隱藏或外露		導管是部分隱藏及部分外露 <sup>1</sup>
		(iii) 電插座及空調機接駁點的位置及數目	請參閱「機電裝置位置及數量說明表」	
h.	氣體供應		裝置	
		類型	煤氣	
		系統	提供煤氣喉接駁煤氣煮食爐及煤氣熱水爐	
		位置	煤氣接駁點的位置請參閱「機電裝置位置及數量說明表」	
i.	洗衣機接駁點	位置及設計	有關配備來水及去水接駁點的位置及設計，請參閱「機電裝置位置及數量說明表」	
j.	供水	水管的用料	冷水喉採用銅喉及熱水喉採用配有隔熱絕緣保護之銅喉	
		水管是隱藏或外露	水管是部分隱藏及部分外露 <sup>2</sup>	
		有否熱水供應	所有浴室、客人洗手間、洗手間及廚房均有熱水供應	

#### 備註：

- 除部分隱藏於混凝土內之導管外，其他部分的導管均為外露。外露的導管可能被假天花、假陣、貯存櫃、覆面、非混凝土間牆、指定之槽位或其他物料遮蓋。
- 除部分隱藏於混凝土內之水管外，其他部分的水管均為外露。外露的水管可能被假天花、假陣、貯存櫃、覆面、非混凝土間牆、指定之槽位或其他物料遮蓋。
- 「Terrace Apartment」、「Garden Apartment」及「Courtyard Penthouse」僅為市場推廣之用的名稱，並不會於關於發展項目的任何公契、臨時買賣合約、買賣合約、轉讓契及契據出現。經批准的建築圖則上顯示的名稱為：第1座1樓A單位（即第1座1樓Terrace Apartment）；第2座地下B單位（即第2座地下Garden Apartment）；第3座地下B單位（即第3座地下Garden Apartment）；第7座地下A單位（即第7座地下Garden Apartment）；第7座11樓Penthouse（即第7座11樓Courtyard Penthouse）；第8座地下B單位（即第8座地下Garden Apartment）；第8座11樓Penthouse（即第8座11樓Courtyard Penthouse）。

**FITTINGS, FINISHES AND APPLIANCES**

**裝置、裝修物料及設備**

**Tower**

4. Miscellaneous									
Item		Description							
a.	Lifts	Brand Name	KONE						
		Model Number, Number of Lifts and Floors Served	Residential Lift			Fireman's Lift			
			Tower	Number of Lift for each Tower	Model Number	Floor Served by the Lifts	Number of Lift for each Tower	Model Number	Floor Served by the Lifts
			Tower 1 & Tower 3	2	Minispace MX18	The following floors are served by lift respectively:- - B/F, G/F, 2/F, 3/F, 5/F -11/F - B/F, G/F, 1/F - 3/F, 5/F - 10/F	1	Minispace MX14	B/F, G/F, 1/F-3/F, 5/F-11/F
			Tower 2	2	Minispace MX14	The following floors are served by lift respectively:- B/F, G/F, 2/F, 3/F, 5/F - 10/F B/F, G/F, 1/F - 3/F, 5/F - 10/F			
Tower 5, Tower 6, Tower 7 & Tower 8	1	Minispace MX14	All served B/F, G/F, 1/F-3/F, 5/F-11/F						
b.	Letter box	Material	Stainless steel letter box						
c.	Refuse collection	(i) Means of refuse collection	Collected by cleaners and handle at refuse storage and material recovery room						
		(ii) Location of refuse room	Refuse storage and material recovery room is provided in the common area of each residential floor of towers						
d.	Water meter, electricity meter and gas meter		Water meter	Electricity meter	Gas meter				
		(i) Location	Inside common water meter cabinet	Inside electricity meter at common electricity meter room on respective residential floor	please refer to "Schedule of Mechanical & Electrical Provision"				
		(ii) Whether they are separate or communal meters for residential properties	Separate meter	Separate meter	Separate meter				

The vendor undertakes that if lifts or appliances of the specified brand name or model number are not installed in the Development, lifts or appliances of comparable quality will be installed.

## FITTINGS, FINISHES AND APPLIANCES

### 裝置、裝修物料及設備

#### 大樓

4. 雜項											
細項		品牌名稱		描述							
a.	升降機	品牌名稱		通力							
		產品型號、升降機數量及可到達的樓層		住宅升降機				消防員升降機			
				座數	每座提供的升降機數量	產品型號	可到達的樓層	每座提供的升降機數量	產品型號	可到達的樓層	
				第1座及第3座	2	Minispace MX18	兩部住宅升降機分別穿梭以下樓層：- - B/F, G/F, 2/F, 3/F, 5/F-11/F - B/F, G/F, 1/F-3/F, 5/F-10/F	1	Minispace MX14	B/F, G/F, 1/F-3/F, 5/F-11/F	
第2座	2	Minispace MX14	兩部住宅升降機分別穿梭以下樓層：- - B/F, G/F, 2/F, 3/F, 5/F-10/F - B/F, G/F, 1/F-3/F, 5/F-10/F								
第5座、第6座、第7座及第8座	1	Minispace MX14	B/F, G/F, 1/F-3/F, 5/F-11/F								
b.	信箱	用料		不銹鋼信箱							
c.	垃圾收集	(i) 垃圾收集的方法		由清潔工人收集垃圾並於物料回收房收集處理							
		(ii) 垃圾房的位置		垃圾及物料回收室位於大廈每層住宅樓層之公用地方							
d.	水錶、電錶及氣體錶			水錶		電錶		氣體錶			
		(i) 位置		設於公共用水錶箱內		設於大廈住宅樓層之公共電錶櫃內		請參閱「機電裝置數量說明表」			
		(ii) 就住宅單位而言是獨立或公用的錶		獨立錶		獨立錶		獨立錶			

賣方承諾如該項目中沒有安裝指明的品牌名稱或產品型號的升降機或設備，便會安裝品質相若的升降機或設備。



## FITTINGS, FINISHES AND APPLIANCES

### 裝置、裝修物料及設備

#### Tower

5. Security Facilities		
Item	Description	
Security system and equipment	Access control and security system	Visitor intercom panel with smart card reader is provided at Development main entrance and main entrance lobbies of each residential tower. Smart card access control is provided.
	Video, door phone and panic alarm system	Door phone is provided at each residential unit, except the following residential unit are equipped with video door phone :- <ul style="list-style-type: none"><li>- • Terrace Apartment on 1/F of Tower 1</li><li>- Garden Duplex on G/F - 1/F of Tower 1, Tower 2 &amp; Tower 3</li><li>- • Garden Apartment on G/F of Tower 2, Tower 3, Tower 7 &amp; Tower 8</li><li>- Sky Pool Penthouse on 11/F of Tower 1, Tower 3, Tower 5 &amp; Tower 6</li><li>- Spa Duplex A &amp; Spa Duplex B on 10/F-11/F of Tower 2</li><li>- • Courtyard Penthouse on 11/F of Tower 7 &amp; Tower 8</li></ul> Panic alarm button is provided for master bedrooms of all residential units. Panic alarms system are connected to the caretaker's office, except the motion sensors, security window & door contacts and glass break detector are added to the following residential units at G/F. <ul style="list-style-type: none"><li>- Garden Duplex on G/F-1/F of Tower 1, Tower 2, Tower 3</li><li>- • Garden Apartment on G/F of Tower 2 &amp; Tower 3</li></ul>
	Perimeter Security System & CCTV	CCTV cameras are provided at Development main entrance, common landscape area, recreational facilities, driveway, carpark entrance, carpark and replacement access along site perimeter. Perimeter infrared sensors are provided at replacement access along site perimeter. Both system are connected to caretaker's office.

6. Appliances	
Item	Description
Appliances	For brand names and model number of appliance provided, please refer to the "Appliances Schedule".

#### Note:

• "Terrace Apartment", "Garden Apartment" and "Courtyard Penthouse" are names for marketing purposes only and will not appear in any Deed of Mutual Covenant, the Preliminary Agreement for Sale and Purchase, Agreement for Sale and Purchase, Assignment, or any other title deeds and documents relating to the Development. The names as appearing on the approved building plans are: Flat A on 1/F of Tower 1 for Terrace Apartment on 1/F of Tower 1; Flat B on G/F of Tower 2 for Garden Apartment on G/F of Tower 2; Flat B on G/F of Tower 3 for Garden Apartment on G/F of Tower 3; Flat A on G/F of Tower 7 for Garden Apartment on G/F of Tower 7; Penthouse on 11/F of Tower 7 for Courtyard Penthouse on 11/F of Tower 7; Flat B on G/F of Tower 8 for Garden Apartment on G/F of Tower 8; Penthouse on 11/F of Tower 8 for Courtyard Penthouse on 11/F of Tower 8.

## FITTINGS, FINISHES AND APPLIANCES

### 裝置、裝修物料及設備

#### 大樓

5. 保安設施		
細項	描述	
保安系統及設備	通道控系統及住宅保安系統	訪客對講系統及智能卡系統裝設於屋苑主入口及各住宅大廈的主入口，智能卡出入系統設於停車場入口。
	視像對講機及警報按鈕系統	各住宅單位均裝有對講機並連接住宅大廈大堂入口的對講機，唯以下住宅單位裝有視象對講機：- - 第1座1樓 • Terrace Apartment - 第1座、第2座及第3座地下至1樓 • Garden Duplex - 第2座、第3座、第7座及第8座地下 • Garden Apartment - 第1座、第3座、第5座及第6座11樓Sky Pool Penthouse - 第2座10樓至11樓Spa Duplex A 及 Spa Duplex B - 第7座及第8座11樓 • Courtyard Penthouse 各住宅單位主人睡房均設有求救警報按鈕。所有求救警報按鈕均連接管理員辦事處。唯以下住宅單位地下加設動態感應器、紅外線感應器、窗戶及出入門之磁力感應器、玻璃破碎感應器：- - 第1座、第2座及第3座地下至1樓 • Garden Duplex - 第2座及第3座 • Garden Apartment
	屋苑邊界保安系統及閉路電視	屋苑主入口、公共園景區、康樂設施、車輛通道、停車場入口、停車場及屋苑邊界公共行人通道裝有閉路電視系統；屋苑邊界公共行人通道裝有紅外線感應器；邊界紅外線感應系統和閉路電視系統均連接管理員辦事處。

6. 裝置	
細項	描述
裝置	有關裝置和設備的品牌及產品型號，請參閱「裝置說明表」。

#### 備註：

• 「Terrace Apartment」、「Garden Apartment」及「Courtyard Penthouse」僅為市場推廣之用的名稱，並不會於關於發展項目的任何公契、臨時買賣合約、買賣合約、轉讓契及契據出現。經批准的建築圖則上顯示的名稱為：第1座1樓A單位（即第1座1樓Terrace Apartment）；第2座地下B單位（即第2座地下Garden Apartment）；第3座地下B單位（即第3座地下Garden Apartment）；第7座地下A單位（即第7座地下Garden Apartment）；第7座11樓Penthouse（即第7座11樓Courtyard Penthouse）；第8座地下B單位（即第8座地下Garden Apartment）；第8座11樓Penthouse（即第8座11樓Courtyard Penthouse）。

## FITTINGS, FINISHES AND APPLIANCES

### 裝置、裝修物料及設備

#### Appliances Schedule - Air-conditioner 設備說明表-冷氣機

##### House 洋房

Location 位置	Appliances 設備		Model Number 產品型號	House 洋房										
				House 1 - 2, 5 - 7 1至2、5至7號 洋房	House 3 3號洋房	House 8 - 10 8至10號洋房	House 11 11號洋房	House 12 12號洋房	House 15 - 19 & House 21- 22 15至19號洋房及 21至22號洋房	House 20 20號洋房	House 23 23號洋房	House 25 - 28 25至28號洋房		
Living Room & Dining Room, Master Bedroom 1, 2 & 3, Ensuite 1, 2 & 3, Kitchen, Utility Room 1, 2 & 3, Corridor, Store Room 1 & 2, Staircase (if applicable) 客廳及飯廳、 主人睡房1、2及3、 套房1、2及3、 廚房、工作間 1、2及3、 走廊、儲物室 1及2、 樓梯 (如適用)	VRF Air-conditioner 變頻中央空調系 統	Indoor Unit 室內機	General 珍寶	ASHA07GACH	2	2	2	2	2	2	2	2	5	2
				ASHA09GACH	—	—	—	—	—	—	—	—	1	—
				ARXB09GALH	1	1	1	1	1	1	2	2	1	1
				ASHA14GACH	—	—	2	4	2	2	2	1	2	
				ASHA18GACH	2	—	2	1	2	—	—	1	—	
				ARXB18GALH	3	5	3	—	4	—	2	—	3	
		ASHA24GACH		2	—	—	1	2	2	1	4	2		
		ARXB24GALH		—	2	—	3	—	3	3	4	—		
		AJHA72LALH		1	1	2	—	—	1	1	—	2		
		AJHA90LALH		1	1	—	2	2	1	1	—	—		
		AJH126LALH		—	—	—	—	—	—	—	2	—		

The vendor undertakes that if lifts or appliances of the specified brand name or model number are not installed in the Development, lifts or appliances of comparable quality will be installed.

##### Notes:

1. The number as shown in the above table denotes the number of appliance(s) is/are provided and/or installed in the residential property.
2. The symbol “—” as shown in the above table denotes “Not provided”.
3. The symbol “ / ” as shown in the above table denotes “Not applicable”.

賣方承諾如該發展項目中沒有安裝指明的品牌名稱或產品型號的升降機或設備，便會安裝品質相若的升降機或設備。

##### 備註:

1. 上表內之數字代表此設備數量於該住宅物業內提供及 / 或安裝。
2. 上表內之「—」代表「不提供」。
3. 上表內之「 / 」代表「不適用」。

# FITTINGS, FINISHES AND APPLIANCES

## 裝置、裝修物料及設備

### Appliances Schedule - Air-conditioner

#### 設備說明表-冷氣機

#### Tower 1 第1座

Location 位置	Appliances 設備		Model Number 產品型號		Flat 單位				
					G/F - 1/F 地下至1樓	1/F 1樓	2/F - 3/F, 5/F - 10/F 2樓至3樓、5樓至10樓	2/F - 3/F, 5/F - 10/F 2樓至3樓、5樓至10樓	11/F - R/F 11樓至天台
					Garden Duplex	• Terrace Apartment	Flat A A單位	Flat B B單位	Sky Pool Penthouse
Living Room & Dining Room, Master Bedroom, Ensuite 1 客廳及飯廳、主人睡房、套房 1	Split Type Air-conditioner 分體式冷氣機	Indoor Unit 室內機	ASWG18LFCB	/	1	1	1	/	
			ASWG24LFCB	/	3	3	3	/	
		Outdoor Unit 室外機	AOWG18LFCB	/	1	1	1	/	
			AOWG24LFCB	/	3	3	3	/	
Ensuite 2 & 3, Kitchen, Store Room 1 套房 2 及 3、廚房、 儲物室 1	Multi Split Type Air-conditioner 多聯分體式冷氣機	Indoor Unit 室內機	ASHG07LMCA	/	1	1	1	/	
			ARHG09LLTA	/	1	1	1	/	
		Outdoor Unit 室外機	ASHG14LMCA	/	2	2	2	/	
			AOHG18LAT3	/	2	2	2	/	
Living Room & Dining Room, Master Bedroom, Ensuite 1, 2 & 3, Family Room, Kitchen, Store Room 1 客廳及飯廳, 主人睡房、套房 1、2 及 3、 家庭室、廚房、儲物室 1	VRF Air-conditioner 變頻中央空調系統	Indoor Unit 室內機	ASHA07GACH	1	/	/	/	1	
			ARXB09GALH	1	/	/	/	1	
			ASHA14GACH	4	/	/	/	3	
			ASHA18GACH	1	/	/	/	2	
			ASHA24GACH	2	/	/	/	—	
			ARXB24GALH	3	/	/	/	4	
			AJH108LALH	2	/	/	/	1	
		AJH126LALH	—	/	/	/	1		
		Outdoor Unit 室外機							

The vendor undertakes that if lifts or appliances of the specified brand name or model number are not installed in the Development, lifts or appliances of comparable quality will be installed.

Notes:

- The number as shown in the above table denotes the number of appliance(s) is/are provided and/or installed in the residential property.
- The symbol “—” as shown in the above table denotes “Not provided”.
- The symbol “/” as shown in the above table denotes “Not applicable”.
- “Terrace Apartment”, “Garden Apartment” and “Courtyard Penthouse” are names for marketing purposes only and will not appear in any Deed of Mutual Covenant, the Preliminary Agreement for Sale and Purchase, Agreement for Sale and Purchase, Assignment, or any other title deeds and documents relating to the Development. The names as appearing on the approved building plans are: Flat A on 1/F of Tower 1 for Terrace Apartment on 1/F of Tower 1; Flat B on G/F of Tower 2 for Garden Apartment on G/F of Tower 2; Flat B on G/F of Tower 3 for Garden Apartment on G/F of Tower 3; Flat A on G/F of Tower 7 for Garden Apartment on G/F of Tower 7; Penthouse on 11/F of Tower 7 for Courtyard Penthouse on 11/F of Tower 7; Flat B on G/F of Tower 8 for Garden Apartment on G/F of Tower 8; Penthouse on 11/F of Tower 8 for Courtyard Penthouse on 11/F of Tower 8.

賣方承諾如該發展項目中沒有安裝指明的品牌名稱或產品型號的升降機或設備，便會安裝品質相若的升降機或設備。

備註：

- 上表內之數字代表此設備數量於該住宅物業內提供及 / 或安裝。
- 上表內之「—」代表「不提供」。
- 上表內之「/」代表「不適用」。
- 「Terrace Apartment」、「Garden Apartment」及「Courtyard Penthouse」僅為市場推廣之用的名稱，並不會於關於發展項目的任何公契、臨時買賣合約、買賣合約、轉讓契及契據出現。經批准的建築圖則上顯示的名稱為：第 1 座 1 樓 A 單位（即第 1 座 1 樓 Terrace Apartment）；第 2 座地下 B 單位（即第 2 座地下 Garden Apartment）；第 3 座地下 B 單位（即第 3 座地下 Garden Apartment）；第 7 座地下 A 單位（即第 7 座地下 Garden Apartment）；第 7 座 11 樓 Penthouse（即第 7 座 11 樓 Courtyard Penthouse）；第 8 座地下 B 單位（即第 8 座地下 Garden Apartment）；第 8 座 11 樓 Penthouse（即第 8 座 11 樓 Courtyard Penthouse）。



# FITTINGS, FINISHES AND APPLIANCES

## 裝置、裝修物料及設備

### Appliances Schedule - Air-conditioner

#### 設備說明表-冷氣機

#### Tower 2 第2座

Location 位置	Appliances 設備		Model Number 產品型號	Flat 單位				
				G/F - 1/F 地下至1樓	G/F 地下	2/F - 3/F, 5/F - 10/F 2樓至3樓、5樓至10樓	1/F - 3/F, 5/F-10/F 1樓至3樓、5樓至10樓	10/ F - R/F 10樓至天台
				Garden Duplex	• Garden Apartment	Flat A A單位	Flat B B單位	Spa Duplex A & Spa Duplex B
Living Room & Dining Room, Master Bedroom, Ensuite 1 客廳及飯廳、主人睡房、套房 1	Split Type Air-conditioner 分體式冷氣機	Indoor Unit 室內機	ASWG18LFCB			1	1	
		Outdoor Unit 室外機	ASWG24LFCB			3	3	
			AOWG18LFCB			1	1	
		AOWG24LFCB			3	3		
Ensuite 2 & 3, Kitchen, Utility Room 套房 2 及 3、廚房、 工作間	Multi Split Type Air-conditioner 多聯分體式冷氣機	Indoor Unit 室內機	ASHG07LMCA			1	1	
		Outdoor Unit 室外機	ARHG09LLTA			1	1	
			ASHG14LMCA			2	2	
		AOHG18LAT3			2	2		
Living Room & Dining Room, Master Bedroom, Ensuite 1, 2 & 3, Study Room, Utility Room, Kitchen, Store Room 1 (if applicable) 客廳及飯廳、 主人睡房、套房 1 及 2 及 3、書 房、工作間、廚房、儲物室 1 (如適用)	VRF Air-conditioner 變頻中央空調系統	Indoor Unit 室內機	ASHA07GACH	1	1			1
			ARXB09GALH	1	1			1
			ASHA09GACH	—	—			2
			ASHA14GACH	4	2			2
			ASHA18GACH	2	1			1
			ASHA24GACH	1	1			2
		Outdoor Unit 室外機	ARXB24GALH	4	—			—
			ARXB30GALH	—	2			4
			AJHA72LALH	—	2			—
			AJH108LALH	1	—			1
			AJH126LALH	1	—			1
			General 珍寶					

The vendor undertakes that if lifts or appliances of the specified brand name or model number are not installed in the Development, lifts or appliances of comparable quality will be installed.

Notes:

- The number as shown in the above table denotes the number of appliance(s) is/are provided and/or installed in the residential property.
- The symbol “—” as shown in the above table denotes “Not provided”.
- The symbol “/” as shown in the above table denotes “Not applicable”.
- “Terrace Apartment”, “Garden Apartment” and “Courtyard Penthouse” are names for marketing purposes only and will not appear in any Deed of Mutual Covenant, the Preliminary Agreement for Sale and Purchase, Agreement for Sale and Purchase, Assignment, or any other title deeds and documents relating to the Development. The names as appearing on the approved building plans are: Flat A on 1/F of Tower 1 for Terrace Apartment on 1/F of Tower 1; Flat B on G/F of Tower 2 for Garden Apartment on G/F of Tower 2; Flat B on G/F of Tower 3 for Garden Apartment on G/F of Tower 3; Flat A on G/F of Tower 7 for Garden Apartment on G/F of Tower 7; Penthouse on 11/F of Tower 7 for Courtyard Penthouse on 11/F of Tower 7; Flat B on G/F of Tower 8 for Garden Apartment on G/F of Tower 8; Penthouse on 11/F of Tower 8 for Courtyard Penthouse on 11/F of Tower 8.

賣方承諾如該發展項目中沒有安裝指明的品牌名稱或產品型號的升降機或設備，便會安裝品質相若的升降機或設備。

備註:

- 上表內之數字代表此設備數量於該住宅物業內提供及 / 或安裝。
- 上表內之「—」代表「不提供」。
- 上表內之「/」代表「不適用」。
- 「Terrace Apartment」、「Garden Apartment」及「Courtyard Penthouse」僅為市場推廣之用的名稱，並不會於關於發展項目的任何公契、臨時買賣合約、買賣合約、轉讓契及契據出現。經批准的建築圖則上顯示的名稱為：第 1 座 1 樓 A 單位（即第 1 座 1 樓 Terrace Apartment）；第 2 座地下 B 單位（即第 2 座地下 Garden Apartment）；第 3 座地下 B 單位（即第 3 座地下 Garden Apartment）；第 7 座地下 A 單位（即第 7 座地下 Garden Apartment）；第 7 座 11 樓 Penthouse（即第 7 座 11 樓 Courtyard Penthouse）；第 8 座地下 B 單位（即第 8 座地下 Garden Apartment）；第 8 座 11 樓 Penthouse（即第 8 座 11 樓 Courtyard Penthouse）。

# FITTINGS, FINISHES AND APPLIANCES

## 裝置、裝修物料及設備

### Appliances Schedule - Air-conditioner

#### 設備說明表-冷氣機

#### Tower 3 第3座

Location 位置	Appliances 設備		Model Number 產品型號		Flat 單位				
					G/F - 1/F 地下至1樓	G/F 地下	2/F - 3/F, 5/F - 10/F 2樓至3樓、5樓至10樓	1/F - 3/F, 5/F-10/F 1樓至3樓, 5樓至10樓	11/ F - R/F 11樓至天台
					Garden Duplex	• Garden Apartment	Flat A A單位	Flat B B單位	Sky Pool Penthouse
Living Room & Dining Room, Master Bedroom, Ensuite 1 客廳及飯廳、主人睡房、套房 1	Split Type Air-conditioner 分體式冷氣機	Indoor Unit 室內機	General 珍寶	ASWG18LFCB			1	1	
				ASWG24LFCB			3	3	
		Outdoor Unit 室外機		AOWG18LFCB			1	1	
				AOWG24LFCB			3	3	
Ensuite 2 & 3, Kitchen, Utility Room 套房 2 及 3、廚房、 工作間	Multi Split Type Air-conditioner 多聯分體式冷氣機	Indoor Unit 室內機	ASHG07LMCA			1	1		
			ARHG09LLTA			1	1		
		Outdoor Unit 室外機	ASHG14LMCA			2	2		
			AOHG18LAT3			2	2		
Living Room & Dining Room, Master Bedroom, Ensuite 1, 2 & 3, Utility Room, Lavatory, Kitchen, Store Room 1 (if applicable) 客廳及飯廳、 主人睡房、套房 1 及 2 及 3、 工作間、洗手間、 廚房、儲物室 1 (如適用)	VRF Air-conditioner 變頻中央空調系統	Indoor Unit 室內機	ASHA07GACH	1	1			1	
			ARXB09GALH	1	1			1	
			ASHA14GACH	4	2			3	
			ASHA18GACH	1	1			2	
			ASHA24GACH	2	4			—	
		Outdoor Unit 室外機	ARXB24GALH	3	—			4	
			AJHA72LALH	—	1			—	
			AJHA90LALH	—	1			—	
			AJH108LALH	2	—			1	
			AJH126LALH	—	—			1	

The vendor undertakes that if lifts or appliances of the specified brand name or model number are not installed in the Development, lifts or appliances of comparable quality will be installed.

Notes:

- The number as shown in the above table denotes the number of appliance(s) is/are provided and/or installed in the residential property.
- The symbol “—” as shown in the above table denotes “Not provided”.
- The symbol “/” as shown in the above table denotes “Not applicable”.
- “Terrace Apartment”, “Garden Apartment” and “Courtyard Penthouse” are names for marketing purposes only and will not appear in any Deed of Mutual Covenant, the Preliminary Agreement for Sale and Purchase, Agreement for Sale and Purchase, Assignment, or any other title deeds and documents relating to the Development. The names as appearing on the approved building plans are: Flat A on 1/F of Tower 1 for Terrace Apartment on 1/F of Tower 1; Flat B on G/F of Tower 2 for Garden Apartment on G/F of Tower 2; Flat B on G/F of Tower 3 for Garden Apartment on G/F of Tower 3; Flat A on G/F of Tower 7 for Garden Apartment on G/F of Tower 7; Penthouse on 11/F of Tower 7 for Courtyard Penthouse on 11/F of Tower 7; Flat B on G/F of Tower 8 for Garden Apartment on G/F of Tower 8; Penthouse on 11/F of Tower 8 for Courtyard Penthouse on 11/F of Tower 8.

賣方承諾如該發展項目中沒有安裝指明的品牌名稱或產品型號的升降機或設備，便會安裝品質相若的升降機或設備。

備註:

- 上表內之數字代表此設備數量於該住宅物業內提供及 / 或安裝。
- 上表內之“—”代表「不提供」。
- 上表內之“/”代表「不適用」。
- 「Terrace Apartment」、「Garden Apartment」及「Courtyard Penthouse」僅為市場推廣之用的名稱，並不會於關於發展項目的任何公契、臨時買賣合約、買賣合約、轉讓契及契據出現。經批准的建築圖則上顯示的名稱為：第 1 座 1 樓 A 單位（即第 1 座 1 樓 Terrace Apartment）；第 2 座地下 B 單位（即第 2 座地下 Garden Apartment）；第 3 座地下 B 單位（即第 3 座地下 Garden Apartment）；第 7 座地下 A 單位（即第 7 座地下 Garden Apartment）；第 7 座 11 樓 Penthouse（即第 7 座 11 樓 Courtyard Penthouse）；第 8 座地下 B 單位（即第 8 座地下 Garden Apartment）；第 8 座 11 樓 Penthouse（即第 8 座 11 樓 Courtyard Penthouse）。

**FITTINGS, FINISHES AND APPLIANCES**
**裝置、裝修物料及設備**
**Appliances Schedule - Air-conditioner**
**設備說明表-冷氣機**
**Tower 5 第5座**

Location 位置	Appliances 設備		Model Number 產品型號		Flat 單位		
					1/F - 3/F, 5/F - 10/F 1樓至3樓、5樓至10樓	1/F - 3/F, 5/F - 10/F 1樓至3樓、5樓至10樓	11/F - R/F 11樓至天台
					Flat A A單位	Flat B B單位	Sky Pool Penthouse
Living Room & Dining Room, Master Bedroom, Ensuite 客廳及飯廳、主人睡房、套房	Split Type Air-conditioner 分體式冷氣機	Indoor Unit 室內機	General 珍寶	ASWG18LFCB	3	3	
				ASWG24LFCB	1	1	
		Outdoor Unit 室外機		AOWG18LFCB	3	3	
				AOWG24LFCB	1	1	
Bedroom 1 & 2, Kitchen, Utility Room 睡房 1 及 2、廚房、 工作間	Multi Split Type Air-conditioner 多聯分體式冷氣機	Indoor Unit 室內機		ASHG07LMCA	1	1	
				ARHG09LLTA	1	1	
		Outdoor Unit 室外機		ASHG14LMCA	2	2	
				AOHG18LAT3	3	3	
Living Room & Dining Room, Master Bedroom, Ensuite 1, 2 & 3, Utility Room, Kitchen, Store Room 客廳及飯廳、 主人睡房、套房 1、2 及 3、 工作間、廚房、儲物室	VRF Air-conditioner 變頻中央空調系統	Indoor Unit 室內機	ASHA07GACH			1	
			ARXB09GALH			1	
			ASHA14GACH			3	
			ASHA24GACH			1	
			ARXB30GALH			4	
		Outdoor Unit 室外機	AJH108LALH			2	

The vendor undertakes that if lifts or appliances of the specified brand name or model number are not installed in the Development, lifts or appliances of comparable quality will be installed.

**Notes:**

1. The number as shown in the above table denotes the number of appliance(s) is/are provided and/or installed in the residential property.
2. The symbol “—” as shown in the above table denotes “Not provided”.
3. The symbol “/” as shown in the above table denotes “Not applicable”.

賣方承諾如該發展項目中沒有安裝指明的品牌名稱或產品型號的升降機或設備，便會安裝品質相若的升降機或設備。

**備註:**

1. 上表內之數字代表此設備數量於該住宅物業內提供及 / 或安裝。
2. 上表內之「—」代表「不提供」。
3. 上表內之「/」代表「不適用」。

**FITTINGS, FINISHES AND APPLIANCES**
**裝置、裝修物料及設備**
**Appliances Schedule - Air-conditioner**
**設備說明表-冷氣機**
**Tower 6 第6座**

Location 位置	Appliances 設備		Model Number 產品型號		Flat 單位		
					1/F - 3/F, 5/F - 10/F 1樓至3樓、5樓至10樓	1/F - 3/F, 5/F - 10/F 1樓至3樓、5樓至10樓	11/F - R/F 11樓至天台
					Flat A A單位	Flat B B單位	Sky Pool Penthouse
Living Room & Dining Room, Master Bedroom, Ensuite 客廳及飯廳、主人睡房、套房	Split Type Air-conditioner 分體式冷氣機	Indoor Unit 室內機	General 珍寶	ASWG18LFCB	3	3	
				ASWG24LFCB	1	1	
		Outdoor Unit 室外機		AOWG18LFCB	3	3	
				AOWG24LFCB	1	1	
Bedroom 1 & 2, Kitchen, Utility Room 睡房 1 及 2、廚房、工作間	Multi Split Type Air-conditioner 多聯分體式冷氣機	Indoor Unit 室內機		ASHG07LMCA	1	1	
				ARHG09LLTA	1	1	
		Outdoor Unit 室外機		ASHG14LMCA	2	2	
				AOHG18LAT3	3	3	
Living Room & Dining Room, Master Bedroom, Ensuite 1, 2 & 3, Utility Room, Kitchen, Store Room 1 客廳及飯廳、 主人睡房、套房 1、2 及 3、 工作間、廚房、儲物室 1	VRF Air-conditioner 變頻中央空調系統	Indoor Unit 室內機	ASHA07GACH			1	
			ARXB09GALH			1	
			ASHA14GACH			3	
			ASHA24GACH			1	
			ARXB30GALH			4	
		Outdoor Unit 室外機	AJH108LALH			2	

The vendor undertakes that if lifts or appliances of the specified brand name or model number are not installed in the Development, lifts or appliances of comparable quality will be installed.

**Notes:**

1. The number as shown in the above table denotes the number of appliance(s) is/are provided and/or installed in the residential property.
2. The symbol “—” as shown in the above table denotes “Not provided”.
3. The symbol “/” as shown in the above table denotes “Not applicable”.

賣方承諾如該發展項目中沒有安裝指明的品牌名稱或產品型號的升降機或設備，便會安裝品質相若的升降機或設備。

**備註:**

1. 上表內之數字代表此設備數量於該住宅物業內提供及 / 或安裝。
2. 上表內之「—」代表「不提供」。
3. 上表內之「/」代表「不適用」。



# FITTINGS, FINISHES AND APPLIANCES

## 裝置、裝修物料及設備

### Appliances Schedule - Air-conditioner

#### 設備說明表-冷氣機

#### Tower 7 第7座

Location 位置	Appliances 設備		Model Number 產品型號		Flat 單位			
					G/F 地下	1/F - 3/F, 5/F - 10/F 1樓至3樓、5樓至10樓	1/F - 3/F, 5/F - 10/F 1樓至3樓、5樓至10樓	11/F - R/F 11樓至天台
					• Garden Apartment	Flat A A單位	Flat B B單位	• Courtyard Penthouse
Living Room & Dining Room, Master Bedroom, Ensuite 客廳及飯廳、主人睡房、套房	Split Type Air-conditioner 分體式冷氣機	Indoor Unit 室內機	ASWG18LFCB		3	3		
		Outdoor Unit 室外機	ASWG24LFCB		1	1		
	Multi Split Type Air-conditioner 多聯分體式冷氣機	Indoor Unit 室內機	AOWG18LFCB		3	3		
		Outdoor Unit 室外機	AOWG24LFCB		1	1		
Bedroom 1 & 2, Kitchen, Utility Room 睡房 1 及 2、廚房、 工作間	Multi Split Type Air-conditioner 多聯分體式冷氣機	Indoor Unit 室內機	ASHG07LMCA		1	1		
		Outdoor Unit 室外機	ARHG09LLTA		1	1		
	VRF Air-conditioner 變頻中央空調系統	Indoor Unit 室內機	ASHG14LMCA		2	2		
		Outdoor Unit 室外機	AOHG18LAT3		3	3		
Living Room & Dining Room, Master Bedroom, Ensuite 1, 2 & 3, Utility Room, Ensuite, Bedroom 1 & 2, Kitchen, Store Room, (if applicable) 客廳及飯廳、 主人睡房、套房 1、2 及 3、 工作間、套房、睡房1及2、 廚房、儲物室 (如適用)	Indoor Unit 室內機	ASHA07GACH		1		1		
		ARXB09GALH		1		1		
		ASHA14GACH		3		3		
		ASHA18GACH		2		—		
	Outdoor Unit 室外機	ASHA24GACH		1		1		
		ARXB30GALH		—		5		
		AJHA72LALH		2		—		
		AJH108LALH		—		1		
AJH126LALH		—		1				

The vendor undertakes that if lifts or appliances of the specified brand name or model number are not installed in the Development, lifts or appliances of comparable quality will be installed.

Notes:

- The number as shown in the above table denotes the number of appliance(s) is/are provided and/or installed in the residential property.
- The symbol “—” as shown in the above table denotes “Not provided”.
- The symbol “/” as shown in the above table denotes “Not applicable”.
- “Terrace Apartment”, “Garden Apartment” and “Courtyard Penthouse” are names for marketing purposes only and will not appear in any Deed of Mutual Covenant, the Preliminary Agreement for Sale and Purchase, Agreement for Sale and Purchase, Assignment, or any other title deeds and documents relating to the Development. The names as appearing on the approved building plans are: Flat A on 1/F of Tower 1 for Terrace Apartment on 1/F of Tower 1; Flat B on G/F of Tower 2 for Garden Apartment on G/F of Tower 2; Flat B on G/F of Tower 3 for Garden Apartment on G/F of Tower 3; Flat A on G/F of Tower 7 for Garden Apartment on G/F of Tower 7; Penthouse on 11/F of Tower 7 for Courtyard Penthouse on 11/F of Tower 7; Flat B on G/F of Tower 8 for Garden Apartment on G/F of Tower 8; Penthouse on 11/F of Tower 8 for Courtyard Penthouse on 11/F of Tower 8.

賣方承諾如該發展項目中沒有安裝指明的品牌名稱或產品型號的升降機或設備，便會安裝品質相若的升降機或設備。

備註：

- 上表內之數字代表此設備數量於該住宅物業內提供及 / 或安裝。
- 上表內之「—」代表「不提供」。
- 上表內之「/」代表「不適用」。
- 「Terrace Apartment」、「Garden Apartment」及「Courtyard Penthouse」僅為市場推廣之用的名稱，並不會於關於發展項目的任何公契、臨時買賣合約、買賣合約、轉讓契及契據出現。經批准的建築圖則上顯示的名稱為：第1座1樓A單位（即第1座1樓Terrace Apartment）；第2座地下B單位（即第2座地下Garden Apartment）；第3座地下B單位（即第3座地下Garden Apartment）；第7座地下A單位（即第7座地下Garden Apartment）；第7座11樓Penthouse（即第7座11樓Courtyard Penthouse）；第8座地下B單位（即第8座地下Garden Apartment）；第8座11樓Penthouse（即第8座11樓Courtyard Penthouse）。



# FITTINGS, FINISHES AND APPLIANCES

## 裝置、裝修物料及設備

### Appliances Schedule - Air-conditioner

#### 設備說明表-冷氣機

#### Tower 8 第8座

Location 位置	Appliances 設備		Model Number 產品型號		Flat 單位					
					G/F 地下	1/F - 3/F, 5/F - 10/F 1樓至3樓、5樓至10樓	1/F - 3/F, 5/F - 8/F &10/F 1樓至3樓、5樓至8樓及10樓	9/F 9樓		11/F 11樓
					• Garden Apartment	Flat A A單位	Flat B B單位	Flat A A單位	Flat B B單位	• Courtyard Penthouse
Living Room & Dining Room, Master Bedroom, Ensuite 客廳及飯廳、主人睡房、套房	Split Type Air-conditioner 分體式冷氣機	Indoor Unit 室內機	ASWG18LFCB	/	3	3	3	3	/	
		Outdoor Unit 室外機	AOWG18LFCB	/	3	3	3	3	/	
	Multi Split Type Air-conditioner 多聯分體式冷氣機	Indoor Unit 室內機	ASHG07LMCA	/	1	1	1	1	/	
		Outdoor Unit 室外機	AOHG18LAT3	/	3	3	3	3	/	
Living Room & Dining Room, Master Bedroom, Ensuite 1, 2 & 3, Utility Room, Ensuite, Bedroom 1 & 2, Kitchen, Store Room (if applicable) 客廳及飯廳、 主人睡房, 套房 1、2 及 3、 工作間、套房、 睡房1及2、廚房、儲物室 (如適用)	VRF Air-conditioner 變頻中央空調系統	Indoor Unit 室內機	ARHG09LLTA	/	1	1	1	2	/	
			ASHG14LMCA	/	2	2	2	2	/	
			ASHA07GACH	1	/	/	/	/	1	
			ARXB09GALH	1	/	/	/	/	1	
		Outdoor Unit 室外機	AJHA72LALH	2	/	/	/	/	/	
			AJH108LALH	-	/	/	/	/	1	
			AJH126LALH	-	/	/	/	/	1	
			ASHA14GACH	3	/	/	/	/	3	
ASHA18GACH	2	/	/	/	/	-				
ASHA24GACH	1	/	/	/	/	1				

The vendor undertakes that if lifts or appliances of the specified brand name or model number are not installed in the Development, lifts or appliances of comparable quality will be installed.

Notes:

- The number as shown in the above table denotes the number of appliance(s) is/are provided and/or installed in the residential property.
- The symbol “-” as shown in the above table denotes “Not provided”.
- The symbol “/” as shown in the above table denotes “Not applicable”.
- “Terrace Apartment”, “Garden Apartment” and “Courtyard Penthouse” are names for marketing purposes only and will not appear in any Deed of Mutual Covenant, the Preliminary Agreement for Sale and Purchase, Agreement for Sale and Purchase, Assignment, or any other title deeds and documents relating to the Development. The names as appearing on the approved building plans are: Flat A on 1/F of Tower 1 for Terrace Apartment on 1/F of Tower 1; Flat B on G/F of Tower 2 for Garden Apartment on G/F of Tower 2; Flat B on G/F of Tower 3 for Garden Apartment on G/F of Tower 3; Flat A on G/F of Tower 7 for Garden Apartment on G/F of Tower 7; Penthouse on 11/F of Tower 7 for Courtyard Penthouse on 11/F of Tower 7; Flat B on G/F of Tower 8 for Garden Apartment on G/F of Tower 8; Penthouse on 11/F of Tower 8 for Courtyard Penthouse on 11/F of Tower 8.

賣方承諾如該發展項目中沒有安裝指明的品牌名稱或產品型號的升降機或設備，便會安裝品質相若的升降機或設備。

備註：

- 上表內之數字代表此設備數量於該住宅物業內提供及 / 或安裝。
- 上表內之“-”代表「不提供」。
- 上表內之“/”代表「不適用」。
- 「Terrace Apartment」、「Garden Apartment」及「Courtyard Penthouse」僅為市場推廣之用的名稱，並不會於關於發展項目的任何公契、臨時買賣合約、買賣合約、轉讓契及契據出現。經批准的建築圖則上顯示的名稱為：第1座1樓A單位（即第1座1樓Terrace Apartment）；第2座地下B單位（即第2座地下Garden Apartment）；第3座地下B單位（即第3座地下Garden Apartment）；第7座地下A單位（即第7座地下Garden Apartment）；第7座11樓Penthouse（即第7座11樓Courtyard Penthouse）；第8座地下B單位（即第8座地下Garden Apartment）；第8座11樓Penthouse（即第8座11樓Courtyard Penthouse）。

**FITTINGS, FINISHES AND APPLIANCES**
**裝置、裝修物料及設備**
**Appliances Schedule**
**設備說明表**

Location 位置	Appliances 設備	Brand Name 品牌名稱	House 1, 2, 5-7 1、2、5至7號洋房	House 3 3號洋房	House 8 - 10 8至10號洋房	House 11 11號洋房	House 12 12號洋房
			Model Number 產品型號	Model Number 產品型號	Model Number 產品型號	Model Number 產品型號	Model Number 產品型號
Kitchen 廚房	Wall mounted cooker hood 掛牆式抽油煙機	Miele	DA429-6C	DA429-6C	DA429-6C	DA429-6C	DA429-6C
	2-burner Gas hob 雙頭氣體煮食爐	Miele	CS1013-1	CS1013-1	CS1013-1	CS1013-1	CS1013-1
	Wok-burner Gas hob 炒鑊氣體煮食爐	Miele	CS1018	CS1018	CS1018	CS1018	CS1018
	2-zone Induction hob 雙頭電磁爐	Miele	CS1212-li	CS1212-li	CS1212-li	CS1212-li	CS1212-li
	Microwave oven 微波爐	Miele	M6262	M6262	M6262	M6262	M6262
	Steam Oven 蒸爐	Miele	DG6200	DG6200	DG6200	DG6200	DG6200
	Oven 焗爐	Miele	H6260B	H6260B	H6260B	H6260B	H6260B
	Wine conditioning unit 酒櫃	Miele	KWT6321UG	KWT6321UG	KWT6321UG	KWT 1612Vi	KWT 1602Vi
	Refrigerator 雪櫃	Gaggenau	RY492 301	RY492 301	RY492 301	RF 411 301 & RC 472 301	RF 411 301 & RC 472 301
	Dishwasher 洗碗碟機	Miele	—	—	—	G6660SCVi	G6660SCVi
	Exhaust Fan 抽氣扇	Ostberg 奧斯博格	DFE 133-20 ErP AC	DFE 133-20 ErP AC	DFE 133-20 ErP AC	DFE 133-20 ErP AC	DFE 133-20 ErP AC
	Gas Water Heater 煤氣熱水爐	TGC	—	—	—	—	—
Master Bedroom 主人睡房	Projector 投影機	Acer	—	—	—	—	
Master Bedroom 1 主人睡房1	Smart TV 智能電視	Samsung 三星	—	UA49NU7100J	—	—	
Master Bedroom 2 主人睡房2	Smart TV 智能電視	Samsung 三星	—	UA49NU7100J	—	—	

The vendor undertakes that if lifts or appliances of the specified brand name or model number are not installed in the Development, lifts or appliances of comparable quality will be installed.

Notes:

1. The symbol “—” as shown in the above table denotes “Not provided”
2. The symbol “/” as shown in the above table denotes “Not applicable”

賣方承諾如該發展項目中沒有安裝指明的品牌名稱或產品型號的升降機或設備，便會安裝品質相若的升降機或設備。

備註：

1. 上表內之「—」代表「不提供」。
2. 上表內之「/」代表「不適用」。

**FITTINGS, FINISHES AND APPLIANCES**
**裝置、裝修物料及設備**
**Appliances Schedule**
**設備說明表**

Location 位置	Appliances 設備	Brand Name 品牌名稱	House 15-19, 21 & 22 15至19、21及22號洋房	House 20 20號洋房	House 23 23號洋房	House 25 - 28 25至28號洋房
			Model Number 產品型號	Model Number 產品型號	Model Number 產品型號	Model Number 產品型號
Kitchen 廚房	Wall mounted cooker hood 掛牆式抽油煙機	Miele	DA429-6C	DA429-6C	DA429-6C	DA429-6C
	2-burner Gas hob 雙頭氣體煮食爐	Miele	CS1013-1	CS1013-1	CS1013-1	CS1013-1
	Wok-burner Gas hob 炒鑊氣體煮食爐	Miele	CS1018	CS1018	CS1018	CS1018
	2-zone Induction hob 雙頭電磁爐	Miele	CS1212-li	CS1212-li	CS1212-li	CS1212-li
	Microwave oven 微波爐	Miele	M6262	M6262	M6262	M6262
	Steam Oven 蒸爐	Miele	DG6200	DG6200	DG6200	DG6200
	Oven 焗爐	Miele	H6260B	H6260B	H6260B	H6260B
	Wine conditioning unit 酒櫃	Miele	KWT6321UG	KWT6321UG	KWT 1602Vi	KWT6321UG
	Refrigerator 雪櫃	Gaggenau	RY492 301	RY492 301	RF 411 301 & RC 472 301	RY492 301
	Dishwasher 洗碗碟機	Miele	—	—	G6660SCVi	—
	Exhaust Fan 抽氣扇	Ostberg 奧斯博格	DFE 133-20 ErP AC	DFE 133-20 ErP AC	RK400X200C1	DFE 133-20 ErP AC
	Gas Water Heater 煤氣熱水爐	TGC	—	—	—	—
Master Bedroom 主人睡房	Projector 投影機	Acer	—	H-7860	—	—
Master Bedroom 1 主人睡房1	Smart TV 智能電視	Samsung 三星	—	—	—	—
Master Bedroom 2 主人睡房2	Smart TV 智能電視	Samsung 三星	—	—	—	—

The vendor undertakes that if lifts or appliances of the specified brand name or model number are not installed in the Development, lifts or appliances of comparable quality will be installed.

Notes:

1. The symbol “—” as shown in the above table denotes “Not provided”
2. The symbol “/” as shown in the above table denotes “Not applicable”

賣方承諾如該發展項目中沒有安裝指明的品牌名稱或產品型號的升降機或設備，便會安裝品質相若的升降機或設備。

備註：

1. 上表內之「—」代表「不提供」。
2. 上表內之「/」代表「不適用」。

**FITTINGS, FINISHES AND APPLIANCES**
**裝置、裝修物料及設備**
**Appliances Schedule**
**設備說明表**

Location 位置	Appliances 設備	Brand Name 品牌名稱	House 1, 2, 5-7 1、2、5至7號洋房	House 3 3號洋房	House 8 - 10 8至10號洋房	House 11 11號洋房	House 12 12號洋房
			Model Number 產品型號	Model Number 產品型號	Model Number 產品型號	Model Number 產品型號	Model Number 產品型號
Ensuite 1 套房 1	Smart TV 智能電視	Samsung 三星	—	—	—	—	—
Ensuite 2 套房 2	Smart TV 智能電視	Samsung 三星	—	—	—	—	—
Master Bathroom 主人浴室	Exhaust Fan 抽氣扇	Ostberg 奧斯博格					
	Thermo-ventilator 浴室寶	Panasonic					
Master Bathroom 1 主人浴室 1	LED TV LED電視	Oolaa	BTV 15 (MG)	BTV 15 (MG)	BTV 15 (MG)	BTV 15 (MG)	BTV 15 (MG)
	Exhaust Fan 抽氣扇	Ostberg 奧斯博格	LPK 125 B	LPK 125 B	—	—	LPK 125 B
	Thermo-ventilator 浴室寶	Panasonic	FV-40BE2H	—	FV-40BE2H	FV-40BE2H	FV-40BE2H
Master Bathroom 2 主人浴室 2	LED TV LED電視	Oolaa	BTV 15 (MG)	BTV 15 (MG)	BTV 15 (MG)	BTV 15 (MG)	BTV 15 (MG)
	Exhaust Fan 抽氣扇	Ostberg 奧斯博格	LPK 125 B	LPK 125 B	—	LPK 125 B	LPK 125 B
	Thermo-ventilator 浴室寶	Panasonic	FV-40BE2H	—	FV-40BE2H	FV-40BE2H	FV-40BE2H
Master Bathroom 3 主人浴室 3	LED TV LED電視	Oolaa					
	Exhaust Fan 抽氣扇	Ostberg 奧斯博格					
	Thermo-ventilator 浴室寶	Panasonic					
Bathroom 1 浴室1	Exhaust Fan 抽氣扇	Ostberg 奧斯博格	LPK 125 A	LPK 125 A	LPK 125 A	LPK 125 A	LPK 125 A

The vendor undertakes that if lifts or appliances of the specified brand name or model number are not installed in the Development, lifts or appliances of comparable quality will be installed.

Notes:

1. The symbol “—” as shown in the above table denotes “Not provided”
2. The symbol “/” as shown in the above table denotes “Not applicable”

賣方承諾如該發展項目中沒有安裝指明的品牌名稱或產品型號的升降機或設備，便會安裝品質相若的升降機或設備。

備註：

1. 上表內之「—」代表「不提供」。
2. 上表內之「/」代表「不適用」。

**FITTINGS, FINISHES AND APPLIANCES**
**裝置、裝修物料及設備**
**Appliances Schedule**
**設備說明表**

Location 位置	Appliances 設備	Brand Name 品牌名稱	House 15-19, 21 & 22 15至19、21及22號洋房	House 20 20號洋房	House 23 23號洋房	House 25 - 28 25至28號洋房
			Model Number 產品型號	Model Number 產品型號	Model Number 產品型號	Model Number 產品型號
Ensuite 1 套房 1	Smart TV 智能電視	Samsung 三星	—	Q6FNA	—	—
Ensuite 2 套房 2	Smart TV 智能電視	Samsung 三星	—	Q6FNA	—	—
Master Bathroom 主人浴室	Exhaust Fan 抽氣扇	Ostberg 奧斯博格		LPK 125 A		
	Thermo-ventilator 浴室寶	Panasonic		FV-40BE2H		
Master Bathroom 1 主人浴室 1	LED TV LED電視	Oolaa	BTV 15 (MG)		—	BTV 15 (MG)
	Exhaust Fan 抽氣扇	Ostberg 奧斯博格	—		LPK 125 B	LPK 125 B
	Thermo-ventilator 浴室寶	Panasonic	FV-40BE2H		FV-40BE2H	FV-40BE2H
Master Bathroom 2 主人浴室 2	LED TV LED電視	Oolaa	BTV 15 (MG)		—	BTV 15 (MG)
	Exhaust Fan 抽氣扇	Ostberg 奧斯博格	—		LPK 125 B	LPK 125 B
	Thermo-ventilator 浴室寶	Panasonic	FV-40BE2H		FV-40BE2H	FV-40BE2H
Master Bathroom 3 主人浴室 3	LED TV LED電視	Oolaa			—	
	Exhaust Fan 抽氣扇	Ostberg 奧斯博格			DFE 133-20EvPAC	
	Thermo-ventilator 浴室寶	Panasonic			FV-40BE2H	
Bathroom 1 浴室1	Exhaust Fan 抽氣扇	Ostberg 奧斯博格	LPK 125 A	LPK 125 A	LPK 125 A	LPK 125 A

The vendor undertakes that if lifts or appliances of the specified brand name or model number are not installed in the Development, lifts or appliances of comparable quality will be installed.

Notes:

1. The symbol “—” as shown in the above table denotes “Not provided”
2. The symbol “/” as shown in the above table denotes “Not applicable”

賣方承諾如該發展項目中沒有安裝指明的品牌名稱或產品型號的升降機或設備，便會安裝品質相若的升降機或設備。

備註：

1. 上表內之「—」代表「不提供」。
2. 上表內之「/」代表「不適用」。



## FITTINGS, FINISHES AND APPLIANCES

### 裝置、裝修物料及設備

#### Appliances Schedule

#### 設備說明表

Location 位置	Appliances 設備	Brand Name 品牌名稱	House 1-2, 5-7 1至2、5至7號洋房	House 3 3號洋房	House 8 - 10 8至10號洋房	House 11 11號洋房	House 12 12號洋房
			Model Number 產品型號	Model Number 產品型號	Model Number 產品型號	Model Number 產品型號	Model Number 產品型號
Bathroom 2 浴室2	LED TV LED電視	Oolaa	—	BTV 15 (MG)	—	—	—
	Exhaust Fan 抽氣扇	Ostberg 奧斯博格	LPK 125 A	LPK 125 A	LPK 125 A	LPK 125 A	LPK 125 A
Bathroom 3 浴室3	Exhaust Fan 抽氣扇	Ostberg 奧斯博格	/	/	/	LPK 125 A	LPK 125 A
Lavatory 洗手間	Exhaust Fan 抽氣扇	Ostberg 奧斯博格	LPK 100 A	LPK 100 A	/	LPK 100 A	LPK 100 A
Powder Room at G/F 地下客廳洗手間	Exhaust Fan 抽氣扇	Ostberg 奧斯博格	LPK 100 A	LPK 100 A	LPK 100 A	LPK 100 A	LPK 100 A
Powder Room at 1/F 一樓客廳洗手間	Exhaust Fan 抽氣扇	Ostberg 奧斯博格	/	/	/	/	/
Roof 天台	Gas Water Heater 煤氣熱水爐	TGC	TNJW221TFQL	TNJW221TFQL	TNJW221TFQL	TNJW221TFQL	TNJW221TFQL
Utility Room 工作間	Washing machine 洗衣機	Miele	WDA 101	WDA 101	WDA 101	WDA 101	WDA 101
	Tumble dryer 乾衣機	Miele	TDA140C	TDA140C	TDA140C	TDA140C	TDA140C

The vendor undertakes that if lifts or appliances of the specified brand name or model number are not installed in the Development, lifts or appliances of comparable quality will be installed.

Notes:

1. The symbol “—” as shown in the above table denotes “Not provided”
2. The symbol “/” as shown in the above table denotes “Not applicable”

賣方承諾如該發展項目中沒有安裝指明的品牌名稱或產品型號的升降機或設備，便會安裝品質相若的升降機或設備。

備註：

1. 上表內之「—」代表「不提供」。
2. 上表內之「/」代表「不適用」。

## FITTINGS, FINISHES AND APPLIANCES

### 裝置、裝修物料及設備

#### Appliances Schedule

#### 設備說明表

Location 位置	Appliances 設備	Brand Name 品牌名稱	House 15-19, 21 & 22 15至19、21及22號洋房	House 20 20號洋房	House 23 23號洋房	House 25 - 28 25至28號洋房
			Model Number 產品型號	Model Number 產品型號	Model Number 產品型號	Model Number 產品型號
Bathroom 2 浴室2	LED TV LED電視	Oolaa	—	—	—	—
	Exhaust Fan 抽氣扇	Ostberg 奧斯博格	LPK 125 A	LPK 125 A	LPK 125 A	LPK 125 A
Bathroom 3 浴室3	Exhaust Fan 抽氣扇	Ostberg 奧斯博格	/	/	LPK 125A	/
Lavatory 洗手間	Exhaust Fan 抽氣扇	Ostberg 奧斯博格	LPK 100 A	LPK 100 A	LPK 100 A	LPK 100 A
Powder Room at G/F 地下客廳洗手間	Exhaust Fan 抽氣扇	Ostberg 奧斯博格	LPK 100 A	LPK 100 A	LPK 125A	LPK 100 A
Powder Room at 1/F 一樓客廳洗手間	Exhaust Fan 抽氣扇	Ostberg 奧斯博格	/	LPK 125 A	/	/
Roof 天台	Gas Water Heater 煤氣熱水爐	TGC	TN JW221TFQL	TN JW221TFQL	TN JW221TFQL	TN JW221TFQL
Utility Room 工作間	Washing machine 洗衣機	Miele	WDA 101	WDA 101	WDA 101	WDA 101
	Tumble dryer 乾衣機	Miele	TDA140C	TDA140C	TDA140C	TDA140C

The vendor undertakes that if lifts or appliances of the specified brand name or model number are not installed in the Development, lifts or appliances of comparable quality will be installed.

Notes:

1. The symbol “—” as shown in the above table denotes “Not provided”
2. The symbol “/” as shown in the above table denotes “Not applicable”

賣方承諾如該發展項目中沒有安裝指明的品牌名稱或產品型號的升降機或設備，便會安裝品質相若的升降機或設備。

備註：

1. 上表內之「—」代表「不提供」。
2. 上表內之「/」代表「不適用」。

## FITTINGS, FINISHES AND APPLIANCES

### 裝置、裝修物料及設備

#### Appliances Schedule

#### 設備說明表

Location 位置	Appliances 設備	Brand Name 品牌名稱	Tower 1 第 1 座			
			G/F - 1/F 地下至1樓	1/F 1樓	2/F - 3/F, 5/F - 10/F 2樓至3樓、5樓至10樓	11/F 11樓
			Garden Duplex	• Terrace Apartment	Flat A & Flat B A及B單位	Sky Pool Penthouse
			Model Number 產品型號	Model Number 產品型號	Model Number 產品型號	Model Number 產品型號
Kitchen 廚房	Wall mounted Cooker Hood 掛牆式抽油煙機	Miele	PUR 98W	PUR 98W	PUR 98W	PUR 98W
	2-burner Gas hob 雙頭氣體煮食爐	Miele	CS 1013-1	CS 1013-1	CS 1013-1	CS 1013-1
	Wok-burner Gas hob 炒鑊氣體煮食爐	Miele	CS 1018	CS 1018	CS 1018	CS 1018
	2-zone Induction hob 雙頭電磁爐	Miele	CS 1212-li	CS 1212-li	CS 1212-li	CS 1212-li
	Microwave oven 微波爐	Miele	M 6262	M 6032	M 6032	M 6262
	Steam Oven 蒸爐	Miele	DG 6200	DG 6030	DG 6030	DG 6200
	Oven 焗爐	Miele	H 2661B	H 2661B	H 2661B	H 2661B
	Wine conditioning unit 酒櫃	Miele	KWT 1602 Vi	KWT 6321 UG	KWT 6321 UG	KWT 1612 Vi
	Refrigerator 雪櫃	Miele	KFN 14827 SDE ed/cs-2 K 14820 SD ed/cs	KFN 14827 SDE ed/cs-2 K 14820 SD ed/cs	KFN 14827 SDE ed/cs-2 K 14820 SD ed/cs	KFN 14827 SDE ed/cs-2 K 14820 SD ed/cs
	Washing machine 洗衣機	Miele	WDA 101	WDA 101	WDA 101	WDA 101
	Tumble dryer 乾衣機	Miele	TDA 140C	TDA 140C	TDA 140C	TDA 140C
	Dish Washer 洗碗碟機	Miele	G 6660 SCVi	—	—	G 6660 SCVi
Exhaust Fan 抽氣扇	Ostberg 奧斯博格	DFE 133-24 AC	DFE 133-24 AC	DFE 133-24 AC	RK500X250D1	

The vendor undertakes that if lifts or appliances of the specified brand name or model number are not installed in the Development, lifts or appliances of comparable quality will be installed.

Notes:

- The symbol “—” as shown in the above table denotes “Not provided”
- The symbol “—” as shown in the above table denotes “Not applicable”
- “Terrace Apartment”, “Garden Apartment” and “Courtyard Penthouse” are names for marketing purposes only and will not appear in any Deed of Mutual Covenant, the Preliminary Agreement for Sale and Purchase, Agreement for Sale and Purchase, Assignment, or any other title deeds and documents relating to the Development. The names as appearing on the approved building plans are: Flat A on 1/F of Tower 1 for Terrace Apartment on 1/F of Tower 1; Flat B on G/F of Tower 2 for Garden Apartment on G/F of Tower 2; Flat B on G/F of Tower 3 for Garden Apartment on G/F of Tower 3; Flat A on G/F of Tower 7 for Garden Apartment on G/F of Tower 7; Penthouse on 11/F of Tower 7 for Courtyard Penthouse on 11/F of Tower 7; Flat B on G/F of Tower 8 for Garden Apartment on G/F of Tower 8; Penthouse on 11/F of Tower 8 for Courtyard Penthouse on 11/F of Tower 8.

賣方承諾如該發展項目中沒有安裝指明的品牌名稱或產品型號的升降機或設備，便會安裝品質相若的升降機或設備。

備註：

- 上表內之「—」代表「不提供」。
- 上表內之「—」代表「不適用」。
- 「Terrace Apartment」、「Garden Apartment」及「Courtyard Penthouse」僅為市場推廣之用的名稱，並不會於關於發展項目的任何公契、臨時買賣合約、買賣合約、轉讓契及契據出現。經批准的建築圖則上顯示的名稱為：第1座1樓A單位（即第1座1樓Terrace Apartment）；第2座地下B單位（即第2座地下Garden Apartment）；第3座地下B單位（即第3座地下Garden Apartment）；第7座地下A單位（即第7座地下Garden Apartment）；第7座11樓Penthouse（即第7座11樓Courtyard Penthouse）；第8座地下B單位（即第8座地下Garden Apartment）；第8座11樓Penthouse（即第8座11樓Courtyard Penthouse）。

## FITTINGS, FINISHES AND APPLIANCES

### 裝置、裝修物料及設備

#### Appliances Schedule

#### 設備說明表

Location 位置	Appliances 設備	Brand Name 品牌名稱	Tower 1 第 1 座			
			G/F - 1/F 地下至1樓	1/F 1樓	2/F - 3/F, 5/F - 10/F 2樓至3樓、5樓至10樓	11/F 11樓
			Garden Duplex	• Terrace Apartment	Flat A & Flat B A及B單位	Sky Pool Penthouse
			Model Number 產品型號	Model Number 產品型號	Model Number 產品型號	Model Number 產品型號
Master Bathroom 主人浴室	LED TV LED電視	Oolaa	BTV 15 (MG)	BTV 15 (MG)	BTV 15 (MG)	BTV 15 (MG)
	Exhaust Fan 抽氣扇	Ostberg 奧斯博格	LPK 125 B	LPK 125 B	LPK 125 B	DFE 133-20 ErP AC
	Thermo-ventilator 浴室寶	Panasonic	FV-40BE2H	FV-40BE2H	FV-40BE2H	FV-40BE2H
Bathroom 1 浴室1	Exhaust Fan 抽氣扇	Ostberg 奧斯博格	LPK 125 A	LPK 125 A	LPK 125 A	LPK 125 A
Bathroom 2 浴室2	Exhaust Fan 抽氣扇	Ostberg 奧斯博格	LPK 125 A	LPK 125 A	LPK 125 A	LPK 125 A
Bathroom 3 浴室3	Exhaust Fan 抽氣扇	Ostberg 奧斯博格	LPK 125 A	LPK 125 A	LPK 125 A	LPK 125 A
Powder Room 客廳洗手間	Exhaust Fan 抽氣扇	Ostberg 奧斯博格	LPK 100 A	LPK 125 A	LPK 125 A	LPK 125 A
Lavatory inside Store Room 1 儲物室1內洗手間	Exhaust Fan 抽氣扇	Ostberg 奧斯博格	LPK 100 A			
	Gas Water Heater 煤氣熱水爐	TGC	TNJW221TFQL			
Lavatory inside Utility Room 工作間內洗手間	Exhaust Fan 抽氣扇	Ostberg 奧斯博格		LPK 100 A	LPK 100 A	LPK 100 A
	Gas Water Heater 煤氣熱水爐	TGC		TNJW221TFQL	TNJW221TFQL	TNJW221TFQL

The vendor undertakes that if lifts or appliances of the specified brand name or model number are not installed in the Development, lifts or appliances of comparable quality will be installed.

Notes:

- The symbol “—” as shown in the above table denotes “Not provided”
- The symbol “/” as shown in the above table denotes “Not applicable”
- “Terrace Apartment”, “Garden Apartment” and “Courtyard Penthouse” are names for marketing purposes only and will not appear in any Deed of Mutual Covenant, the Preliminary Agreement for Sale and Purchase, Agreement for Sale and Purchase, Assignment, or any other title deeds and documents relating to the Development. The names as appearing on the approved building plans are: Flat A on 1/F of Tower 1 for Terrace Apartment on 1/F of Tower 1; Flat B on G/F of Tower 2 for Garden Apartment on G/F of Tower 2; Flat B on G/F of Tower 3 for Garden Apartment on G/F of Tower 3; Flat A on G/F of Tower 7 for Garden Apartment on G/F of Tower 7; Penthouse on 11/F of Tower 7 for Courtyard Penthouse on 11/F of Tower 7; Flat B on G/F of Tower 8 for Garden Apartment on G/F of Tower 8; Penthouse on 11/F of Tower 8 for Courtyard Penthouse on 11/F of Tower 8.

賣方承諾如該發展項目中沒有安裝指明的品牌名稱或產品型號的升降機或設備，便會安裝品質相若的升降機或設備。

- 備註：
- 上表內之「—」代表「不提供」。
  - 上表內之「/」代表「不適用」。
  - 「Terrace Apartment」、「Garden Apartment」及「Courtyard Penthouse」僅為市場推廣之用的名稱，並不會於關於發展項目的任何公契、臨時買賣合約、買賣合約、轉讓契及契據出現。經批准的建築圖則上顯示的名稱為：第1座1樓A單位（即第1座1樓Terrace Apartment）；第2座地下B單位（即第2座地下Garden Apartment）；第3座地下B單位（即第3座地下Garden Apartment）；第7座地下A單位（即第7座地下Garden Apartment）；第7座11樓Penthouse（即第7座11樓Courtyard Penthouse）；第8座地下B單位（即第8座地下Garden Apartment）；第8座11樓Penthouse（即第8座11樓Courtyard Penthouse）。

# FITTINGS, FINISHES AND APPLIANCES

## 裝置、裝修物料及設備

### Appliances Schedule

#### 設備說明表

Location 位置	Appliances 設備	Brand Name 品牌名稱	Tower 2 第 2 座					
			G/F - 1/F 地下至1樓	G/F 地下	1/F 1樓	2/F - 3/F, 5/F - 9/F 2樓至3樓、5樓至9樓	10/F - 11/F 10樓至11樓	
			Garden Duplex	• Garden Apartment	Flat B B 單位	Flat A & B A 及 B 單位	Spa Duplex A	Spa Duplex B
			Model Number 產品型號	Model Number 產品型號	Model Number 產品型號	Model Number 產品型號	Model Number 產品型號	Model Number 產品型號
Kitchen 廚房	Wall mounted cooker hood 掛牆式抽油煙機	Miele	PUR 98W	PUR 98W	PUR 98W	PUR 98W	PUR 98W	PUR 98W
	2-burner Gas hob 雙頭氣體煮食爐	Miele	CS 1013-1	CS 1013-1	CS 1013-1	CS 1013-1	CS 1013-1	CS 1013-1
	Wok-burner Gas hob 炒鑊氣體煮食爐	Miele	CS 1018	CS 1018	CS 1018	CS 1018	CS 1018	CS 1018
	2-zone Induction hob 雙頭電磁爐	Miele	CS 1212-li	CS 1212-li	CS 1212-li	CS 1212-li	CS 1212-li	CS 1212-li
	Microwave oven 微波爐	Miele	M 6262	M 6262	M 6032	M 6032	M 6262	M 6262
	Steam Oven 蒸爐	Miele	DG 6200	DG 6200	DG 6030	DG 6030	DG 6200	DG 6200
	Oven 焗爐	Miele	H 2661B	H 2661B	H 2661B	H 2661B	H 2661B	H 2661B
	Wine conditioning unit 酒櫃	Miele	KWT 1612 Vi	KWT 6321 UG	KWT 6321 UG	KWT 6321 UG	KWT 1612 Vi	KWT 1602 Vi
	Refrigerator 雪櫃	Miele	KFN 14827 SDE ed/cs-2 K 14820 SD ed/cs	KFN 14827 SDE ed/cs-2 K 14820 SD ed/cs	—	—	KFN 14827 SDE ed/cs-2 K 14820 SD ed/cs	KFN 14827 SDE ed/cs-2 K 14820 SD ed/cs
		Bosch	—	—	KAN92VI35	KAN92VI35	—	—
	Washing machine 洗衣機	Miele	WDA 101	WDA 101	WDA 101	WDA 101	WDA 101	WDA 101
	Tumble dryer 乾衣機	Miele	TDA 140C	TDA 140C	TDA 140C	TDA 140C	TDA 140C	TDA 140C
	Dishwasher 洗碗碟機	Miele	G 6660 SCVi	G 6660 SCVi	—	—	G 6660 SCVi	G 6660 SCVi
Exhaust Fan 抽氣扇	Ostberg 奧斯博格	DFE 133-24 AC	DFE 133-24 AC	DFE 133-20 ErP AC	DFE 133-20 ErP AC	DFE 133-20 ErP AC	DFE 133-20 ErP AC	

The vendor undertakes that if lifts or appliances of the specified brand name or model number are not installed in the Development, lifts or appliances of comparable quality will be installed.

Notes:

- The symbol “—” as shown in the above table denotes “Not provided”
- The symbol “—/—” as shown in the above table denotes “Not applicable”
- “Terrace Apartment”, “Garden Apartment” and “Courtyard Penthouse” are names for marketing purposes only and will not appear in any Deed of Mutual Covenant, the Preliminary Agreement for Sale and Purchase, Agreement for Sale and Purchase, Assignment, or any other title deeds and documents relating to the Development. The names as appearing on the approved building plans are: Flat A on 1/F of Tower 1 for Terrace Apartment on 1/F of Tower 1; Flat B on G/F of Tower 2 for Garden Apartment on G/F of Tower 2; Flat B on G/F of Tower 3 for Garden Apartment on G/F of Tower 3; Flat A on G/F of Tower 7 for Garden Apartment on G/F of Tower 7; Penthouse on 11/F of Tower 7 for Courtyard Penthouse on 11/F of Tower 7; Flat B on G/F of Tower 8 for Garden Apartment on G/F of Tower 8; Penthouse on 11/F of Tower 8 for Courtyard Penthouse on 11/F of Tower 8.

賣方承諾如該發展項目中沒有安裝指明的品牌名稱或產品型號的升降機或設備，便會安裝品質相若的升降機或設備。

- 備註：
- 上表內之「—」代表「不提供」。
  - 上表內之「—/—」代表「不適用」。
  - 「Terrace Apartment」、「Garden Apartment」及「Courtyard Penthouse」僅為市場推廣之用的名稱，並不會於關於發展項目的任何公契、臨時買賣合約、買賣合約、轉讓契及契據出現。經批准的建築圖則上顯示的名稱為：第 1 座 1 樓 A 單位（即第 1 座 1 樓 Terrace Apartment）；第 2 座地下 B 單位（即第 2 座地下 Garden Apartment）；第 3 座地下 B 單位（即第 3 座地下 Garden Apartment）；第 7 座地下 A 單位（即第 7 座地下 Garden Apartment）；第 7 座 11 樓 Penthouse（即第 7 座 11 樓 Courtyard Penthouse）；第 8 座地下 B 單位（即第 8 座地下 Garden Apartment）；第 8 座 11 樓 Penthouse（即第 8 座 11 樓 Courtyard Penthouse）。



# FITTINGS, FINISHES AND APPLIANCES

## 裝置、裝修物料及設備

### Appliances Schedule

#### 設備說明表

Location 位置	Appliances 設備	Brand Name 品牌名稱	Tower 2 第2座					
			G/F - 1/F 地下至1樓	G/F 地下	1/F 1樓	2/F - 3/F, 5/F - 9/F 2樓至3樓、5樓至9樓	10/F - 11/F 10樓至11樓	
			Garden Duplex	• Garden Apartment	Flat B B單位	Flat A & B A及B單位	Spa Duplex A	Spa Duplex B
			Model Number 產品型號	Model Number 產品型號	Model Number 產品型號	Model Number 產品型號	Model Number 產品型號	Model Number 產品型號
Master Bathroom 主人浴室	LED TV LED電視	Oolaa	BTV 15 (MG)	BTV 15 (MG)	BTV 15 (MG)	BTV 15 (MG)	BTV 15 (MG)	BTV 15 (MG)
	Exhaust Fan 抽氣扇	Ostberg 奧斯博格	LPK 125 B	LPK 125 B	LPK 125 B	LPK 125 B	LPK 125 B	LPK 125 B
	Thermo-ventilator 浴室寶	Panasonic	FV-40BE2H	FV-40BE2H	FV-40BE2H	FV-40BE2H (Except Flat B on 7/F & Flat B on 8/F)	FV-40BE2H	FV-40BE2H
Bathroom 1 浴室1	Exhaust Fan 抽氣扇	Ostberg 奧斯博格	LPK 125 A	LPK 125 A	LPK 125 A	LPK 125 A	LPK 125 A	LPK 125 A
Bathroom 2 浴室2	Exhaust Fan 抽氣扇	Ostberg 奧斯博格	LPK 125 A	LPK 125 A	LPK 125 A	LPK 125 A	LPK 125 A	LPK 125 A
Bathroom 3 浴室3	Exhaust Fan 抽氣扇	Ostberg 奧斯博格	LPK 125 A	LPK 125 A	LPK 125 A	LPK 125 A	LPK 125 A	LPK 125 A
Powder Room 客廳洗手間	Exhaust Fan 抽氣扇	Ostberg 奧斯博格	LPK 125 A	LPK 125 A	LPK 125 A	LPK 125 A (Except Flat B on 7/F & Flat B on 8/F)	LPK 125 A	LPK 125 A
	Gas Water Heater 煤氣熱水爐	TGC	—	TNJW221TFQL	—	—	—	—
Bathroom 4 浴室4	Exhaust Fan 抽氣扇	Ostberg 奧斯博格	LPK 125 B	/	/	/	/	/
Lavatory inside Utility Room 工作間內洗手間	Exhaust Fan 抽氣扇	Ostberg 奧斯博格	—	LPK 100 A	LPK 100 A	LPK 100 A	LPK 100 A	LPK 100 A
	Gas Water Heater 煤氣熱水爐	TGC	—	TNJW221TFQL	TNJW221TFQL	TNJW221TFQL	TNJW221TFQL	TNJW221TFQL
Lavatory inside Master Bedroom 主人房內洗手間	Exhaust Fan 抽氣扇	Ostberg 奧斯博格	LPK 125 B	/	/	/	LPK 125 A	LPK 125 A
Lavatory inside Store Room 1 儲物室1內洗手間	Gas Water Heater 煤氣熱水爐	TGC	TNJW221TFQL	/	/	/	/	/
	Exhaust Fan 抽氣扇	Ostberg 奧斯博格	LPK 100 A	—	—	—	—	—

The vendor undertakes that if lifts or appliances of the specified brand name or model number are not installed in the Development, lifts or appliances of comparable quality will be installed.

Notes:

- The symbol “—” as shown in the above table denotes “Not provided”
- The symbol “/” as shown in the above table denotes “Not applicable”
- “Terrace Apartment”, “Garden Apartment” and “Courtyard Penthouse” are names for marketing purposes only and will not appear in any Deed of Mutual Covenant, the Preliminary Agreement for Sale and Purchase, Agreement for Sale and Purchase, Assignment, or any other title deeds and documents relating to the Development. The names as appearing on the approved building plans are: Flat A on 1/F of Tower 1 for Terrace Apartment on 1/F of Tower 1; Flat B on G/F of Tower 2 for Garden Apartment on G/F of Tower 2; Flat B on G/F of Tower 3 for Garden Apartment on G/F of Tower 3; Flat A on G/F of Tower 7 for Garden Apartment on G/F of Tower 7; Penthouse on 11/F of Tower 7 for Courtyard Penthouse on 11/F of Tower 7; Flat B on G/F of Tower 8 for Garden Apartment on G/F of Tower 8; Penthouse on 11/F of Tower 8 for Courtyard Penthouse on 11/F of Tower 8.

賣方承諾如該發展項目中沒有安裝指明的品牌名稱或產品型號的升降機或設備，便會安裝品質相若的升降機或設備。

備註:

- 上表內之“—”代表「不提供」。
- 上表內之“/”代表「不適用」。
- 「Terrace Apartment」、「Garden Apartment」及「Courtyard Penthouse」僅為市場推廣之用的名稱，並不會於關於發展項目的任何公契、臨時買賣合約、買賣合約、轉讓契及契據出現。經批准的建築圖則上顯示的名稱為：第1座1樓A單位（即第1座1樓Terrace Apartment）；第2座地下B單位（即第2座地下Garden Apartment）；第3座地下B單位（即第3座地下Garden Apartment）；第7座地下A單位（即第7座地下Garden Apartment）；第7座11樓Penthouse（即第7座11樓Courtyard Penthouse）；第8座地下B單位（即第8座地下Garden Apartment）；第8座11樓Penthouse（即第8座11樓Courtyard Penthouse）。

# FITTINGS, FINISHES AND APPLIANCES

## 裝置、裝修物料及設備

### Appliances Schedule

#### 設備說明表

Location 位置	Appliances 設備	Brand Name 品牌名稱	Tower 3 第3座				
			G/F - 1/F 地下至1樓	G/F 地下	1/ F - 10/F 1樓至10樓	2/F - 3/F, 5/F - 10/F 2樓至3樓、5樓至10樓	11/F 11樓
			Garden Duplex	• Garden Apartment	Flat B B 單位	Flat A A單位	Sky Pool Penthouse
			Model Number 產品型號	Model Number 產品型號	Model Number 產品型號	Model Number 產品型號	Model Number 產品型號
Kitchen 廚房	Wall mounted cooker hood 掛牆式抽油煙機	Miele	PUR 98W	PUR 98W	PUR 98W	PUR 98W	PUR 98W
	2-burner Gas hob 雙頭氣體煮食爐	Miele	CS 1013-1	CS 1013-1	CS 1013-1	CS 1013-1	CS 1013-1
	Wok-burner Gas hob 炒鑊氣體煮食爐	Miele	CS 1018	CS 1018	CS 1018	CS 1018	CS 1018
	2-zone Induction hob 雙頭電磁爐	Miele	CS 1212-1i	CS 1212-1i	CS 1212-1i	CS 1212-1i	CS 1212-1i
	Microwave oven 微波爐	Miele	M 6262	M 6262	M 6032	M 6032	M 6262
	Steam Oven 蒸爐	Miele	DG 6200	DG 6200	DG 6030	DG 6030	DG 6200
	Oven 焗爐	Miele	H 2661B	H 2661B	H 2661B	H 2661B	H 2661B
	Wine conditioning unit 酒櫃	Miele	KWT 1612 Vi	KWT 6321 UG	KWT 6321 UG	KWT 6321 UG	KWT 1602 Vi
	Refrigerator 雪櫃	Miele	KFN 14827 SDE ed/cs-2 K 14820 SD ed/cs	KFN 14827 SDE ed/cs-2 K 14820 SD ed/cs	KFN 14827 SDE ed/cs-2 K 14820 SD ed/cs	KFN 14827 SDE ed/cs-2 K 14820 SD ed/cs	KFN 14827 SDE ed/cs-2 K 14820 SD ed/cs
	Washing machine 洗衣機	Miele	WDA 101	WDA 101	WDA 101	WDA 101	WDA 101
	Tumble dryer 乾衣機	Miele	TDA 140C	TDA 140C	TDA 140C	TDA 140C	TDA 140C
	Dishwasher 洗碗碟機	Miele	G 6660 SCVi	G 6660 SCVi	—	—	G 6660 SCVi
Exhaust Fan 抽氣扇	Ostberg 奧斯博格	DFE 133-24 AC	DFE 133-24 AC	DFE 133-24 AC	DFE 133-24 AC	RK500X250D1	

The vendor undertakes that if lifts or appliances of the specified brand name or model number are not installed in the Development, lifts or appliances of comparable quality will be installed.

Notes:

1. The symbol “—” as shown in the above table denotes “Not provided”
2. The symbol “/” as shown in the above table denotes “Not applicable”
3. • “Terrace Apartment”, “Garden Apartment” and “Courtyard Penthouse” are names for marketing purposes only and will not appear in any Deed of Mutual Covenant, the Preliminary Agreement for Sale and Purchase, Agreement for Sale and Purchase, Assignment, or any other title deeds and documents relating to the Development. The names as appearing on the approved building plans are: Flat A on 1/F of Tower 1 for Terrace Apartment on 1/F of Tower 1; Flat B on G/F of Tower 2 for Garden Apartment on G/F of Tower 2; Flat B on G/F of Tower 3 for Garden Apartment on G/F of Tower 3; Flat A on G/F of Tower 7 for Garden Apartment on G/F of Tower 7; Penthouse on 11/F of Tower 7 for Courtyard Penthouse on 11/F of Tower 7; Flat B on G/F of Tower 8 for Garden Apartment on G/F of Tower 8; Penthouse on 11/F of Tower 8 for Courtyard Penthouse on 11/F of Tower 8.

賣方承諾如該發展項目中沒有安裝指明的品牌名稱或產品型號的升降機或設備，便會安裝品質相若的升降機或設備。

備註：

1. 上表內之「—」代表「不提供」。
2. 上表內之「/」代表「不適用」。
3. • 「Terrace Apartment」、「Garden Apartment」及「Courtyard Penthouse」僅為市場推廣之用的名稱，並不會於關於發展項目的任何公契、臨時買賣合約、買賣合約、轉讓契及契據出現。經批准的建築圖則上顯示的名稱為：第1座1樓A單位（即第1座1樓Terrace Apartment）；第2座地下B單位（即第2座地下Garden Apartment）；第3座地下B單位（即第3座地下Garden Apartment）；第7座地下A單位（即第7座地下Garden Apartment）；第7座11樓Penthouse（即第7座11樓Courtyard Penthouse）；第8座地下B單位（即第8座地下Garden Apartment）；第8座11樓Penthouse（即第8座11樓Courtyard Penthouse）。

## FITTINGS, FINISHES AND APPLIANCES

### 裝置、裝修物料及設備

#### Appliances Schedule

#### 設備說明表

Location 位置	Appliances 設備	Brand Name 品牌名稱	Tower 3 第3座				
			G/F - 1/F 地下至1樓	G/F 地下	1/F - 10/F 1樓至10樓	2/F - 3/F, 5/F - 10/F 2樓至3樓、5樓至10樓	11/F 11樓
			Garden Duplex	• Garden Apartment	Flat B B單位	Flat A A單位	Sky Pool Penthouse
			Model Number 產品型號	Model Number 產品型號	Model Number 產品型號	Model Number 產品型號	Model Number 產品型號
Master Bathroom 主人浴室	LED TV LED電視	Oolaa	BTV 15 (MG)	BTV 15 (MG)	BTV 15 (MG)	BTV 15 (MG)	BTV 15 (MG)
	Exhaust Fan 抽氣扇	Ostberg 奧斯博格	LPK 125 B	LPK 125 B	LPK 125 B	LPK 125 B	DFE 133-20 ErP AC
	Thermo-ventilator 浴室寶	Panasonic	FV-40BE2H	FV-40BE2H	FV-40BE2H	FV-40BE2H	FV-40BE2H
Bathroom 1 浴室1	Exhaust Fan 抽氣扇	Ostberg 奧斯博格	LPK 125 A	LPK 125 A	LPK 125 A	LPK 125 A	LPK 125 A
Bathroom 2 浴室2	Exhaust Fan 抽氣扇	Ostberg 奧斯博格	LPK 125 A	LPK 125 A	LPK 125 A	LPK 125 A	LPK 125 A
Bathroom 3 浴室3	Exhaust Fan 抽氣扇	Ostberg 奧斯博格	LPK 125 A	LPK 125 A	LPK 125 A	LPK 125 A	LPK 125 A
Powder Room 客廳洗手間	Exhaust Fan 抽氣扇	Ostberg 奧斯博格	LPK 100 A	LPK 100 A	LPK 125 A	LPK 125 A	LPK 125 A
Lavatory inside Store Room 1 儲物室1內洗手間	Exhaust Fan 抽氣扇	Ostberg 奧斯博格	LPK 100 A				
	Gas Water Heater 煤氣熱水爐	TGC	TN JW221TFQL				
Lavatory inside Utility Room 工作間內 洗手間	Exhaust Fan 抽氣扇	Ostberg 奧斯博格		LPK 100 A	LPK 100 A	LPK 100 A	LPK 100 A
	Gas Water Heater 煤氣熱水爐	TGC		TN JW221TFQL	TN JW221TFQL	TN JW221TFQL	TN JW221TFQL

The vendor undertakes that if lifts or appliances of the specified brand name or model number are not installed in the Development, lifts or appliances of comparable quality will be installed.

Notes:

1. The symbol “—” as shown in the above table denotes “Not provided”
2. The symbol “/” as shown in the above table denotes “Not applicable”
3. • “Terrace Apartment”, “Garden Apartment” and “Courtyard Penthouse” are names for marketing purposes only and will not appear in any Deed of Mutual Covenant, the Preliminary Agreement for Sale and Purchase, Agreement for Sale and Purchase, Assignment, or any other title deeds and documents relating to the Development. The names as appearing on the approved building plans are: Flat A on 1/F of Tower 1 for Terrace Apartment on 1/F of Tower 1; Flat B on G/F of Tower 2 for Garden Apartment on G/F of Tower 2; Flat B on G/F of Tower 3 for Garden Apartment on G/F of Tower 3; Flat A on G/F of Tower 7 for Garden Apartment on G/F of Tower 7; Penthouse on 11/F of Tower 7 for Courtyard Penthouse on 11/F of Tower 7; Flat B on G/F of Tower 8 for Garden Apartment on G/F of Tower 8; Penthouse on 11/F of Tower 8 for Courtyard Penthouse on 11/F of Tower 8.

賣方承諾如該發展項目中沒有安裝指明的品牌名稱或產品型號的升降機或設備，便會安裝品質相若的升降機或設備。

備註：

1. 上表內之「—」代表「不提供」。
2. 上表內之「/」代表「不適用」。
3. • 「Terrace Apartment」、「Garden Apartment」及「Courtyard Penthouse」僅為市場推廣之用的名稱，並不會於關於發展項目的任何公契、臨時買賣合約、買賣合約、轉讓契及契據出現。經批准的建築圖則上顯示的名稱為：第1座1樓A單位（即第1座1樓Terrace Apartment）；第2座地下B單位（即第2座地下Garden Apartment）；第3座地下B單位（即第3座地下Garden Apartment）；第7座地下A單位（即第7座地下Garden Apartment）；第7座11樓Penthouse（即第7座11樓Courtyard Penthouse）；第8座地下B單位（即第8座地下Garden Apartment）；第8座11樓Penthouse（即第8座11樓Courtyard Penthouse）。

**FITTINGS, FINISHES AND APPLIANCES**
**裝置、裝修物料及設備**
**Appliances Schedule**
**設備說明表**

Location 位置	Appliances 設備	Brand Name 品牌名稱	Tower 5 第 5 座		Tower 6 第 6 座	
			1F - 3/F, 5/F - 10/F 1樓至3樓、5樓至10樓	11/F 11樓	1F - 3/F, 5/F - 10/F 1樓至3樓、5樓至10樓	11/F 11樓
			Flat A & B A 及 B 單位	Sky Pool Penthouse	Flat A & B A 及 B 單位	Sky Pool Penthouse
			Model Number 產品型號	Model Number 產品型號	Model Number 產品型號	Model Number 產品型號
Kitchen 廚房	Wall mounted cooker hood 掛牆式抽油煙機	Miele	PUR 98W	—	PUR 98W	—
	Island cooker hood 吊掛式抽油煙機	Miele	—	DA6690D	—	DA6690D
	2-burner Gas hob 雙頭氣體煮食爐	Miele	CS 1013-1	CS 1013-1	CS 1013-1	CS 1013-1
	Wok-burner Gas hob 炒鑊氣體煮食爐	Miele	CS 1018	CS 1018	CS 1018	CS 1018
	2-zone Induction hob 雙頭電磁爐	Miele	CS 1212-li	CS 1212-li	CS 1212-li	CS 1212-li
	Microwave oven 微波爐	Miele	M 6032	M 6262	M 6032	M 6262
	Steam Oven 蒸爐	Miele	DG 6030	DG 6200	DG 6030	DG 6200
	Oven 焗爐	Miele	H 2661B	H 2661B	H 2661B	H 2661B
	Wine conditioning unit 酒櫃	Miele	KWT 6321 UG	KWT 6833 SG	KWT 6321 UG	KWT 6833 SG
	Refrigerator 雪櫃	Miele	—	KFN 14827 SDE ed/cs-2 K 14820 SD ed/cs	—	KFN 14827 SDE ed/cs-2 K 14820 SD ed/cs
		Bosch	KAN92VI35	—	KAN92VI35	—
	Washing machine 洗衣機	Miele	WDA 101	WDA 101	WDA 101	WDA 101
	Tumble dryer 乾衣機	Miele	TDA 140C	TDA 140C	TDA 140C	TDA 140C
	Dishwasher 洗碗碟機	Miele	—	G 6660 SCVi	—	G 6660 SCVi
	Exhaust Fan 抽氣扇	Ostberg 奧斯博格	DFE 133-20 ErP AC	DFE 133-24 AC	DFE 133-20 ErP AC	DFE 133-24 AC
Gas Water Heater 煤氣熱水爐	TGC	TNJW221TFQL	—	TNJW221TFQL	—	

The vendor undertakes that if lifts or appliances of the specified brand name or model number are not installed in the Development, lifts or appliances of comparable quality will be installed.

Notes:

1. The symbol “ — ” as shown in the above table denotes “Not provided”
2. The symbol “ — ” as shown in the above table denotes “Not applicable”

賣方承諾如該發展項目中沒有安裝指明的品牌名稱或產品型號的升降機或設備，便會安裝品質相若的升降機或設備。

備註：

1. 上表內之「 — 」代表「不提供」。
2. 上表內之「 — 」代表「不適用」。

**FITTINGS, FINISHES AND APPLIANCES**
**裝置、裝修物料及設備**
**Appliances Schedule**
**設備說明表**

Location 位置	Appliances 設備	Brand Name 品牌名稱	Tower 5 第 5 座		Tower 6 第 6 座	
			1F - 3/F, 5/F - 10/F 1樓至3樓、5樓至10樓	11/F 11樓	1F - 3/F, 5/F - 10/F 1樓至3樓、5樓至10樓	11/F 11樓
			Flat A & B A 及 B 單位	Sky Pool Penthouse	Flat A & B A 及 B 單位	Sky Pool Penthouse
			Model Number 產品型號	Model Number 產品型號	Model Number 產品型號	Model Number 產品型號
Master Bathroom 主人浴室	LED TV LED電視	Oolaa	BTV 15 (MG)	BTV 15 (MG)	BTV 15 (MG)	BTV 15 (MG)
	Exhaust Fan 抽氣扇	Ostberg 奧斯博格	—	LPK 125 B	—	LPK 125 B
	Thermo-ventilator 浴室寶	Panasonic	FV-40BE2H	FV-40BE2H	FV-40BE2H	FV-40BE2H
Bathroom 1 浴室1	Exhaust Fan 抽氣扇	Ostberg 奧斯博格	LPK 125 A	LPK 125 A	LPK 125 A	LPK 125 A
Bathroom 2 浴室2	Exhaust Fan 抽氣扇	Ostberg 奧斯博格	LPK 125 A	LPK 125 A	LPK 125 A	LPK 125 A
Bathroom 3 浴室3	Exhaust Fan 抽氣扇	Ostberg 奧斯博格	／	LPK 125 A	／	LPK 125 A
Powder Room 客廳洗手間	Exhaust Fan 抽氣扇	Ostberg 奧斯博格	／	LPK 125 A	／	LPK 125 A
Lavatory inside Utility Room 工作間內洗手間	Exhaust Fan 抽氣扇	Ostberg 奧斯博格	LPK 100 A	LPK 100 A	LPK 100 A	LPK 100 A
	Gas Water Heater 煤氣熱水爐	TGC	TNJW221TFQL	TNJW221TFQL	TNJW221TFQL	TNJW221TFQL

The vendor undertakes that if lifts or appliances of the specified brand name or model number are not installed in the Development, lifts or appliances of comparable quality will be installed.

Notes:

1. The symbol “—” as shown in the above table denotes “Not provided”
2. The symbol “／” as shown in the above table denotes “Not applicable”

賣方承諾如該發展項目中沒有安裝指明的品牌名稱或產品型號的升降機或設備，便會安裝品質相若的升降機或設備。

備註：

1. 上表內之「—」代表「不提供」。
2. 上表內之「／」代表「不適用」。



# FITTINGS, FINISHES AND APPLIANCES

## 裝置、裝修物料及設備

### Appliances Schedule

#### 設備說明表

Location 位置	Appliances 設備	Brand Name 品牌名稱	Tower 7 第 7 座		
			G/F 地下	1/F - 3/F, 5/F - 10/F 1樓至3樓、5樓至10樓	11/F 11樓
			• Garden Apartment	Flat A & B A 及 B 單位	• Courtyard Penthouse
			Model Number 產品型號	Model Number 產品型號	Model Number 產品型號
Kitchen 廚房	Wall mounted cooker hood 掛牆式抽油煙機	Miele	PUR 98W	PUR 98W	—
	Island Cooker Hood 吊掛式抽油煙機	Miele	—	—	DA 6690 D
	2-burner Gas hob 雙頭氣體煮食爐	Miele	CS 1013-1	CS 1013-1	CS 1013-1
	Wok-burner Gas hob 炒鑊氣體煮食爐	Miele	CS 1018	CS 1018	CS 1018
	2-zone Induction hob 雙頭電磁爐	Miele	CS 1212-li	CS 1212-li	CS 1212-li
	Microwave oven 微波爐	Miele	M 6262	M 6032	M 6262
	Steam Oven 蒸爐	Miele	DG 6200	DG 6030	DG 6200
	Oven 焗爐	Miele	H 2661B	H 2661B	H 2661B
	Wine conditioning unit 酒櫃	Miele	KWT 6321 UG	KWT 6321 UG	KWT 6833 SG
	Refrigerator 雪櫃	Miele	KFN 14827 SDE ed/cs-2 K 14820 SD ed/cs	—	KFN 14827 SDE ed/cs-2 K 14820 SD ed/cs
		Bosch	—	KAN92VI35	—
	Washing machine 洗衣機	Miele	WDA 101	WDA 101	WDA 101
	Tumble dryer 乾衣機	Miele	TDA 140C	TDA 140C	TDA 140C
	Dishwasher 洗碗碟機	Miele	G 6660 SCVi	—	G 6660 SCVi

The vendor undertakes that if lifts or appliances of the specified brand name or model number are not installed in the Development, lifts or appliances of comparable quality will be installed.

Notes:

- The symbol “—” as shown in the above table denotes “Not provided”
- The symbol “/” as shown in the above table denotes “Not applicable”
- “Terrace Apartment”, “Garden Apartment” and “Courtyard Penthouse” are names for marketing purposes only and will not appear in any Deed of Mutual Covenant, the Preliminary Agreement for Sale and Purchase, Agreement for Sale and Purchase, Assignment, or any other title deeds and documents relating to the Development. The names as appearing on the approved building plans are: Flat A on 1/F of Tower 1 for Terrace Apartment on 1/F of Tower 1; Flat B on G/F of Tower 2 for Garden Apartment on G/F of Tower 2; Flat B on G/F of Tower 3 for Garden Apartment on G/F of Tower 3; Flat A on G/F of Tower 7 for Garden Apartment on G/F of Tower 7; Penthouse on 11/F of Tower 7 for Courtyard Penthouse on 11/F of Tower 7; Flat B on G/F of Tower 8 for Garden Apartment on G/F of Tower 8; Penthouse on 11/F of Tower 8 for Courtyard Penthouse on 11/F of Tower 8.

賣方承諾如該發展項目中沒有安裝指明的品牌名稱或產品型號的升降機或設備，便會安裝品質相若的升降機或設備。

- 備註：
- 上表內之「—」代表「不提供」。
  - 上表內之「/」代表「不適用」。
  - 「Terrace Apartment」、「Garden Apartment」及「Courtyard Penthouse」僅為市場推廣之用的名稱，並不會於關於發展項目的任何公契、臨時買賣合約、買賣合約、轉讓契及契據出現。經批准的建築圖則上顯示的名稱為：第 1 座 1 樓 A 單位（即第 1 座 1 樓 Terrace Apartment）；第 2 座地下 B 單位（即第 2 座地下 Garden Apartment）；第 3 座地下 B 單位（即第 3 座地下 Garden Apartment）；第 7 座地下 A 單位（即第 7 座地下 Garden Apartment）；第 7 座 11 樓 Penthouse（即第 7 座 11 樓 Courtyard Penthouse）；第 8 座地下 B 單位（即第 8 座地下 Garden Apartment）；第 8 座 11 樓 Penthouse（即第 8 座 11 樓 Courtyard Penthouse）。

## FITTINGS, FINISHES AND APPLIANCES

### 裝置、裝修物料及設備

#### Appliances Schedule

#### 設備說明表

Location 位置	Appliances 設備	Brand Name 品牌名稱	Tower 7 第 7 座		
			G/F 地下	1/F - 3/F, 5/F - 10/F 1樓至3樓、5樓至10樓	11/F 11樓
			• Garden Apartment	Flat A & B A 及 B 單位	• Courtyard Penthouse
			Model Number 產品型號	Model Number 產品型號	Model Number 產品型號
Kitchen 廚房	Exhaust Fan 抽氣扇	Ostberg 奧斯博格	DFE 133-20 ErP AC	DFE 133-20 ErP AC	DFE 133-24 AC
	Gas Water Heater 煤氣熱水爐	TGC	—	TNJW221TFQL	—
Master Bathroom 主人浴室	LED TV LED電視	Oolaa	BTV 15 (MG)	BTV 15 (MG)	BTV 15 (MG)
	Thermo-ventilator 浴室寶	Panasonic	FV-40BE2H	FV-40BE2H	FV-40BE2H
Bathroom 1 浴室1	Exhaust Fan 抽氣扇	Ostberg 奧斯博格	LPK 125 A	LPK 125 A	LPK 125 A
Bathroom 2 浴室2	Exhaust Fan 抽氣扇	Ostberg 奧斯博格	LPK 125 A	LPK 125 A	LPK 125 A
Bathroom 3 浴室3	Exhaust Fan 抽氣扇	Ostberg 奧斯博格			LPK 125 A
Powder Room 客廳洗手間	Exhaust Fan 抽氣扇	Ostberg 奧斯博格			LPK 125 A
Lavatory inside Utility Room 工作間內洗手間	Exhaust Fan 抽氣扇	Ostberg 奧斯博格	LPK 100 A	LPK 100 A	LPK 100 A
	Gas Water Heater 煤氣熱水爐	TGC	TNJW221TFQL	TNJW221TFQL	TNJW221TFQL

The vendor undertakes that if lifts or appliances of the specified brand name or model number are not installed in the Development, lifts or appliances of comparable quality will be installed.

Notes:

- The symbol “—” as shown in the above table denotes “Not provided”
- The symbol “/” as shown in the above table denotes “Not applicable”
- “Terrace Apartment”, “Garden Apartment” and “Courtyard Penthouse” are names for marketing purposes only and will not appear in any Deed of Mutual Covenant, the Preliminary Agreement for Sale and Purchase, Agreement for Sale and Purchase, Assignment, or any other title deeds and documents relating to the Development. The names as appearing on the approved building plans are: Flat A on 1/F of Tower 1 for Terrace Apartment on 1/F of Tower 1; Flat B on G/F of Tower 2 for Garden Apartment on G/F of Tower 2; Flat B on G/F of Tower 3 for Garden Apartment on G/F of Tower 3; Flat A on G/F of Tower 7 for Garden Apartment on G/F of Tower 7; Penthouse on 11/F of Tower 7 for Courtyard Penthouse on 11/F of Tower 7; Flat B on G/F of Tower 8 for Garden Apartment on G/F of Tower 8; Penthouse on 11/F of Tower 8 for Courtyard Penthouse on 11/F of Tower 8.

賣方承諾如該發展項目中沒有安裝指明的品牌名稱或產品型號的升降機或設備，便會安裝品質相若的升降機或設備。

- 備註：
- 上表內之「—」代表「不提供」。
  - 上表內之「/」代表「不適用」。
  - 「Terrace Apartment」、「Garden Apartment」及「Courtyard Penthouse」僅為市場推廣之用的名稱，並不會於關於發展項目的任何公契、臨時買賣合約、買賣合約、轉讓契及契據出現。經批准的建築圖則上顯示的名稱為：第 1 座 1 樓 A 單位（即第 1 座 1 樓 Terrace Apartment）；第 2 座地下 B 單位（即第 2 座地下 Garden Apartment）；第 3 座地下 B 單位（即第 3 座地下 Garden Apartment）；第 7 座地下 A 單位（即第 7 座地下 Garden Apartment）；第 7 座 11 樓 Penthouse（即第 7 座 11 樓 Courtyard Penthouse）；第 8 座地下 B 單位（即第 8 座地下 Garden Apartment）；第 8 座 11 樓 Penthouse（即第 8 座 11 樓 Courtyard Penthouse）。

# FITTINGS, FINISHES AND APPLIANCES

## 裝置、裝修物料及設備

### Appliances Schedule

#### 設備說明表

Location 位置	Appliances 設備	Brand Name 品牌名稱	Tower 8 第 8 座				
			G/F 地下	1/F - 3/F, 5/F - 8/F & 10/F 1樓至3樓、5樓至8樓及10樓	9/F 9樓		11/F 11樓
			• Garden Apartment	Flat A & B A 及 B 單位	Flat A A 單位	Flat B B 單位	• Courtyard Penthouse
			Model Number 產品型號	Model Number 產品型號	Model Number 產品型號	Model Number 產品型號	Model Number 產品型號
Kitchen 廚房	Wall mounted cooker hood 掛牆式抽油煙機	Miele	PUR 98W	PUR 98W	PUR 98W	—	—
		Gaggenau	—	—	—	AW240 - 190	—
	Island Cooker Hood 吊掛式抽油煙機	Miele	—	—	—	—	DA 6690 D
	2-burner Gas hob 雙頭氣體煮食爐	Miele	CS 1013-1	CS 1013-1	CS 1013-1	—	CS 1013-1
		Gaggenau	—	—	—	VG232	—
	Wok-burner Gas hob 炒鑊氣體煮食爐	Miele	CS 1018	CS 1018	CS 1018	—	CS 1018
		Gaggenau	—	—	—	VG231	—
	2-zone Induction hob 雙頭電磁爐	Miele	CS 1212-li	CS 1212-li	CS 1212-li	—	CS 1212-li
		Gaggenau	—	—	—	VI230	—
	Microwave oven 微波爐	Miele	M 6262	M 6032	M 6032	—	M 6262
		Gaggenau	—	—	—	BM450	—
	Steam Oven 蒸爐	Miele	DG 6200	DG 6030	DG 6030	—	DG 6200
		Gaggenau	—	—	—	BS450	—
	Oven 焗爐	Miele	H 2661B	H 2661B	H 2661B	—	H 2661B
		Gaggenau	—	—	—	BO450	—

The vendor undertakes that if lifts or appliances of the specified brand name or model number are not installed in the Development, lifts or appliances of comparable quality will be installed.

Notes:

1. The symbol “—” as shown in the above table denotes “Not provided”
2. The symbol “/” as shown in the above table denotes “Not applicable”
3. • “Terrace Apartment”, “Garden Apartment” and “Courtyard Penthouse” are names for marketing purposes only and will not appear in any Deed of Mutual Covenant, the Preliminary Agreement for Sale and Purchase, Agreement for Sale and Purchase, Assignment, or any other title deeds and documents relating to the Development. The names as appearing on the approved building plans are: Flat A on 1/F of Tower 1 for Terrace Apartment on 1/F of Tower 1; Flat B on G/F of Tower 2 for Garden Apartment on G/F of Tower 2; Flat B on G/F of Tower 3 for Garden Apartment on G/F of Tower 3; Flat A on G/F of Tower 7 for Garden Apartment on G/F of Tower 7; Penthouse on 11/F of Tower 7 for Courtyard Penthouse on 11/F of Tower 7; Flat B on G/F of Tower 8 for Garden Apartment on G/F of Tower 8; Penthouse on 11/F of Tower 8 for Courtyard Penthouse on 11/F of Tower 8.

賣方承諾如該發展項目中沒有安裝指明的品牌名稱或產品型號的升降機或設備，便會安裝品質相若的升降機或設備。

備註：

1. 上表內之「—」代表「不提供」。
2. 上表內之「/」代表「不適用」。
3. • 「Terrace Apartment」、「Garden Apartment」及「Courtyard Penthouse」僅為市場推廣之用的名稱，並不會於關於發展項目的任何公契、臨時買賣合約、買賣合約、轉讓契及契據出現。經批准的建築圖則上顯示的名稱為：第 1 座 1 樓 A 單位（即第 1 座 1 樓 Terrace Apartment）；第 2 座地下 B 單位（即第 2 座地下 Garden Apartment）；第 3 座地下 B 單位（即第 3 座地下 Garden Apartment）；第 7 座地下 A 單位（即第 7 座地下 Garden Apartment）；第 7 座 11 樓 Penthouse（即第 7 座 11 樓 Courtyard Penthouse）；第 8 座地下 B 單位（即第 8 座地下 Garden Apartment）；第 8 座 11 樓 Penthouse（即第 8 座 11 樓 Courtyard Penthouse）。

## FITTINGS, FINISHES AND APPLIANCES

### 裝置、裝修物料及設備

#### Appliances Schedule

#### 設備說明表

Location 位置	Appliances 設備	Brand Name 品牌名稱	Tower 8 第 8 座					
			G/F 地下	1/F - 3/F, 5/F - 8/F & 10/F 1樓至3樓、5樓至8樓及10樓	9/F 9樓		11/F 11樓	
			• Garden Apartment	Flat A & B A 及 B 單位	Flat A A 單位	Flat B B 單位	• Courtyard Penthouse	
			Model Number 產品型號	Model Number 產品型號	Model Number 產品型號	Model Number 產品型號	Model Number 產品型號	
Kitchen 廚房	Wine Conditioning Unit 酒櫃	Miele	KWT 6321 UG	KWT 6321 UG	KWT 6321 UG	—	KWT 6833 SG	
		Gaggenau	—	—	—	RW 404	—	
	Warming Drawer 暖盤機	Gaggenau	—	—	—	WS461	—	
	Built-in Coffee Machine 嵌入式咖啡機	Gaggenau	—	—	—	CM450	—	
	Refrigerator 雪櫃	Miele	KFN 14827 SDE ed/cs-2 K 14820 SD ed/cs	—	—	—	—	KFN 14827 SDE ed/cs-2 K 14820 SD ed/cs
		Bosch	—	KAN92VI35	KAN92VI35	—	—	—
		Gaggenau	—	—	—	RC462 - 301 RF411 - 301	—	—
	Washing machine 洗衣機	Miele	WDA 101	WDA 101	WDA 101	—	WDA 101	
	Tumble dryer 乾衣機	Miele	TDA 140C	TDA 140C	TDA 140C	—	TDA 140C	
	Washer-dryer 洗衣乾衣機	Gaggenau	—	—	—	WD200 - 140	—	
	Dishwasher 洗碗碟機	Miele	G 6660 SCVi	—	—	—	G 6660 SCVi	
	Exhaust Fan 抽氣扇	Ostberg 奧斯博格	DFE 133-20 ErP AC	DFE 133-20 ErP AC	DFE 133-20 ErP AC	DFE 133-20 ErP AC	DFE 133-24 AC	
Gas Water Heater 煤氣熱水爐	TGC	—	TNJW221TFQL	TNJW221TFQL	TNJW221TFQL	—		
Living Room & Dining Room 客廳及飯廳	Smart TV 智能電視	Samsung 三星	—	—	—	QA65Q7FNAJXZK	—	

The vendor undertakes that if lifts or appliances of the specified brand name or model number are not installed in the Development, lifts or appliances of comparable quality will be installed.

Notes:

- The symbol “—” as shown in the above table denotes “Not provided”
- The symbol “/” as shown in the above table denotes “Not applicable”
- “Terrace Apartment”, “Garden Apartment” and “Courtyard Penthouse” are names for marketing purposes only and will not appear in any Deed of Mutual Covenant, the Preliminary Agreement for Sale and Purchase, Agreement for Sale and Purchase, Assignment, or any other title deeds and documents relating to the Development. The names as appearing on the approved building plans are: Flat A on 1/F of Tower 1 for Terrace Apartment on 1/F of Tower 1; Flat B on G/F of Tower 2 for Garden Apartment on G/F of Tower 2; Flat B on G/F of Tower 3 for Garden Apartment on G/F of Tower 3; Flat A on G/F of Tower 7 for Garden Apartment on G/F of Tower 7; Penthouse on 11/F of Tower 7 for Courtyard Penthouse on 11/F of Tower 7; Flat B on G/F of Tower 8 for Garden Apartment on G/F of Tower 8; Penthouse on 11/F of Tower 8 for Courtyard Penthouse on 11/F of Tower 8.

賣方承諾如該發展項目中沒有安裝指明的品牌名稱或產品型號的升降機或設備，便會安裝品質相若的升降機或設備。

備註：

- 上表內之「—」代表「不提供」。
- 上表內之「/」代表「不適用」。
- 「Terrace Apartment」、「Garden Apartment」及「Courtyard Penthouse」僅為市場推廣之用的名稱，並不會於關於發展項目的任何公契、臨時買賣合約、買賣合約、轉讓契及契據出現。經批准的建築圖則上顯示的名稱為：第 1 座 1 樓 A 單位（即第 1 座 1 樓 Terrace Apartment）；第 2 座地下 B 單位（即第 2 座地下 Garden Apartment）；第 3 座地下 B 單位（即第 3 座地下 Garden Apartment）；第 7 座地下 A 單位（即第 7 座地下 Garden Apartment）；第 7 座 11 樓 Penthouse（即第 7 座 11 樓 Courtyard Penthouse）；第 8 座地下 B 單位（即第 8 座地下 Garden Apartment）；第 8 座 11 樓 Penthouse（即第 8 座 11 樓 Courtyard Penthouse）。

# FITTINGS, FINISHES AND APPLIANCES

## 裝置、裝修物料及設備

### Appliances Schedule

#### 設備說明表

Location 位置	Appliances 設備	Brand Name 品牌名稱	Tower 8 第 8 座				
			G/F 地下	1/F - 3/F, 5/F - 8/F & 10/F 1樓至3樓、5樓至8樓及10樓	9/F 9樓		11/F 11樓
			• Garden Apartment	Flat A & B A 及 B 單位	Flat A A 單位	Flat B B 單位	• Courtyard Penthouse
			Model Number 產品型號	Model Number 產品型號	Model Number 產品型號	Model Number 產品型號	Model Number 產品型號
Master Bedroom 主人睡房	Smart TV 智能電視	Samsung 三星	—	—	—	UA49NU8000JXZK	—
Ensuite 套房	Smart TV 智能電視	Samsung 三星	—	—	—	UA49NU8000JXZK	—
Bedroom 1 睡房 1	Smart TV 智能電視	Samsung 三星	—	—	—	UA49NU8000JXZK	—
Master Bathroom 主人浴室	LED TV LED電視	Oolaa	BTV 15 (MG)	BTV 15 (MG)	BTV 15 (MG)	—	BTV 15 (MG)
	Exhaust Fan 抽氣扇	Ostberg 奧斯博格	—	—	—	LPK 125 A	—
	Thermo-ventilator 浴室寶	Panasonic	FV-40BE2H	FV-40BE2H	FV-40BE2H	—	FV-40BE2H
Bathroom 1 浴室1	Exhaust Fan 抽氣扇	Ostberg 奧斯博格	LPK 125 A	LPK 125 A	LPK 125 A	LPK 125 A	LPK 125 A
Bathroom 2 浴室2	Exhaust Fan 抽氣扇	Ostberg 奧斯博格	LPK 125 A	LPK 125 A	LPK 125 A	LPK 125 A	LPK 125 A
Bathroom 3 浴室3	Exhaust Fan 抽氣扇	Ostberg 奧斯博格			—	—	LPK 125 A
Powder Room 客廳洗手間	Exhaust Fan 抽氣扇	Ostberg 奧斯博格			—	—	LPK 125 A
Lavatory inside Utility Room 工作間內洗手間	Exhaust Fan 抽氣扇	Ostberg 奧斯博格	LPK 100 A	LPK 100 A	LPK 100 A	LPK 100 A	LPK 100 A
	Gas Water Heater 煤氣熱水爐	TGC	TNJW221TFQL	TNJW221TFQL	TNJW221TFQL	TNJW221TFQL	TNJW221TFQL

The vendor undertakes that if lifts or appliances of the specified brand name or model number are not installed in the Development, lifts or appliances of comparable quality will be installed.

Notes:

1. The symbol “—” as shown in the above table denotes “Not provided”
2. The symbol “/” as shown in the above table denotes “Not applicable”
3. • “Terrace Apartment”, “Garden Apartment” and “Courtyard Penthouse” are names for marketing purposes only and will not appear in any Deed of Mutual Covenant, the Preliminary Agreement for Sale and Purchase, Agreement for Sale and Purchase, Assignment, or any other title deeds and documents relating to the Development. The names as appearing on the approved building plans are: Flat A on 1/F of Tower 1 for Terrace Apartment on 1/F of Tower 1; Flat B on G/F of Tower 2 for Garden Apartment on G/F of Tower 2; Flat B on G/F of Tower 3 for Garden Apartment on G/F of Tower 3; Flat A on G/F of Tower 7 for Garden Apartment on G/F of Tower 7; Penthouse on 11/F of Tower 7 for Courtyard Penthouse on 11/F of Tower 7; Flat B on G/F of Tower 8 for Garden Apartment on G/F of Tower 8; Penthouse on 11/F of Tower 8 for Courtyard Penthouse on 11/F of Tower 8.

賣方承諾如該發展項目中沒有安裝指明的品牌名稱或產品型號的升降機或設備，便會安裝品質相若的升降機或設備。

備註：

1. 上表內之「—」代表「不提供」。
2. 上表內之「/」代表「不適用」。
3. • 「Terrace Apartment」、「Garden Apartment」及「Courtyard Penthouse」僅為市場推廣之用的名稱，並不會於關於發展項目的任何公契、臨時買賣合約、買賣合約、轉讓契及契據出現。經批准的建築圖則上顯示的名稱為：第 1 座 1 樓 A 單位（即第 1 座 1 樓 Terrace Apartment）；第 2 座地下 B 單位（即第 2 座地下 Garden Apartment）；第 3 座地下 B 單位（即第 3 座地下 Garden Apartment）；第 7 座地下 A 單位（即第 7 座地下 Garden Apartment）；第 7 座 11 樓 Penthouse（即第 7 座 11 樓 Courtyard Penthouse）；第 8 座地下 B 單位（即第 8 座地下 Garden Apartment）；第 8 座 11 樓 Penthouse（即第 8 座 11 樓 Courtyard Penthouse）。



# FITTINGS, FINISHES AND APPLIANCES

## 裝置、裝修物料及設備

### Bathroom Schedule

#### 浴室說明

		House 洋房				
		House 1 - 2, 5 - 7 1至2、5至7號洋房	House 3 3號洋房	House 8 - 10 8至10號洋房	House 11 11號洋房	House 12 12號洋房
Master Bathroom 1 主人浴室 1	Bathtub 浴缸 1700mm(L) (長) x 750mm (W) (闊) x 420mm (H) (高)	—	—	—	✓	✓
	Bathtub 浴缸 1600mm(L) (長) x 750mm (W) (闊) x 420mm (H) (高)	✓	—	✓	—	—
	Free Standing Bathtub 獨立式浴缸 1660mm(L) (長) x 750mm (W) (闊) x 535mm (H) (高)	—	✓	—	—	—
	Shower Room 淋浴間	✓	✓	✓	—	✓
Master Bathroom 2 主人浴室 2	Bathtub 浴缸 1700mm(L) (長) x 750mm (W) (闊) x 420mm (H) (高)	—	—	—	—	—
	Bathtub 浴缸 1600mm(L) (長) x 750mm (W) (闊) x 420mm (H) (高)	✓	✓	✓	—	—
	Free Standing Bathtub 獨立式浴缸 1690mm(L) (長) x 925mm (W) (闊) x 550mm (H) (高)	—	—	—	✓	✓
	Shower Room 淋浴間	✓	✓	✓	✓	✓
Master Bathroom 3 主人浴室 3	Free Standing Bathtub 獨立式浴缸 1690mm(L) (長) x 925mm (W) (闊) x 550mm (H) (高)	/	/	/	/	/
	Shower Room 淋浴間	/	/	/	/	/
Bathroom 1 浴室 1	Bathtub 浴缸 1700mm(L) (長) x 750mm (W) (闊) x 420mm (H) (高)	—	—	—	—	—
	Shower Room 淋浴間	✓	✓	✓	✓	✓
Bathroom 2 浴室 2	Bathtub 浴缸 1700mm(L) (長) x 750mm (W) (闊) x 420mm (H) (高)	—	—	—	✓	—
	Bathtub 浴缸 1600mm(L) (長) x 750mm (W) (闊) x 420mm (H) (高)	✓	✓	—	—	—
	Bathtub 浴缸 1500mm(L) (長) x 750mm (W) (闊) x 420mm (H) (高)	—	—	✓	—	—
	Shower Room 淋浴間	—	—	—	—	✓
Bathroom 3 浴室 3	Bathtub 浴缸 1700mm(L) (長) x 750mm (W) (闊) x 420mm (H) (高)	/	/	/	—	✓
	Shower Room 淋浴間	/	/	/	✓	—

Notes:

- The symbol “✓” as shown in the above table denotes such appliance(s) is/are provided and/or installed in the residential property.
- The symbol “—” as shown in the above table denotes “Not provided”.
- The symbol “/” as shown in the above table denotes “Not applicable”.

備註:

- 上表內之「✓」代表此設備於該住宅物業內提供及 / 或安裝。
- 上表內之「—」代表「不提供」。
- 上表內之「/」代表「不適用」。

# FITTINGS, FINISHES AND APPLIANCES

## 裝置、裝修物料及設備

### Bathroom Schedule

#### 浴室說明

		House 洋房			
		House 15 - 19, 21 & 22 15至19、21及22號洋房	House 20 20號洋房	House 23 23號洋房	House 25 - 28 25至28號洋房
Master Bathroom 主人浴室	Free Standing Bathtub 獨立式浴缸 1600mm(L) (長) x 800mm (W) (闊) x 540mm (H) (高)	/	✓	/	/
	Shower Room 淋浴間	/	✓	/	/
Master Bathroom 1 主人浴室 1	Bathtub 浴缸 1700mm(L) (長) x 750mm (W) (闊) x 420mm (H) (高)	-	/	✓	-
	Bathtub 浴缸 1600mm(L) (長) x 750mm (W) (闊) x 420mm (H) (高)	✓	/	-	✓
	Shower Room 淋浴間	✓	/	✓	✓
Master Bathroom 2 主人浴室 2	Bathtub 浴缸 1700mm(L) (長) x 750mm (W) (闊) x 420mm (H) (高)	-	/	✓	-
	Bathtub 浴缸 1600mm(L) (長) x 750mm (W) (闊) x 420mm (H) (高)	✓	/	-	✓
	Shower Room 淋浴間	✓	/	✓	✓
Master Bathroom 3 主人浴室 3	Free Standing Bathtub 獨立式浴缸 1690mm(L) (長) x 925mm (W) (闊) x 550mm (H) (高)	/	/	✓	/
	Shower Room 淋浴間	/	/	✓	/
Bathroom 1 浴室 1	Bathtub 浴缸 1700mm(L) (長) x 750mm (W) (闊) x 420mm (H) (高)	-	-	✓	-
	Shower Room 淋浴間	✓	✓	-	✓
Bathroom 2 浴室 2	Bathtub 浴缸 1700mm(L) (長) x 750mm (W) (闊) x 420mm (H) (高)	-	-	-	-
	Bathtub 浴缸 1600mm(L) (長) x 750mm (W) (闊) x 420mm (H) (高)	✓	✓	-	✓
	Bathtub 浴缸 1500mm(L) (長) x 750mm (W) (闊) x 420mm (H) (高)	-	-	-	-
	Shower Room 淋浴間	-	-	✓	-
Bathroom 3 浴室 3	Bathtub 浴缸 1700mm(L) (長) x 750mm (W) (闊) x 420mm (H) (高)	/	/	-	/
	Shower Room 淋浴間	/	/	✓	/

Notes:

- The symbol “✓” as shown in the above table denotes such appliance(s) is/are provided and/or installed in the residential property.
- The symbol “-” as shown in the above table denotes “Not provided”.
- The symbol “/” as shown in the above table denotes “Not applicable”.

備註:

- 上表內之「✓」代表此設備於該住宅物業內提供及 / 或安裝。
- 上表內之「-」代表「不提供」。
- 上表內之「/」代表「不適用」。

## FITTINGS, FINISHES AND APPLIANCES

### 裝置、裝修物料及設備

#### Bathroom Schedule

#### 浴室說明

		Tower 1 第 1 座			
Location 位置	Floor 樓層	G/F - 1/F 地下至1樓	1/F 1樓	2/F - 3/F, 5/F - 10/F 2樓至3樓、5樓至10樓	11/F 11樓
	Unit 單位	Garden Duplex	• Terrace Apartment	Flat A & B A 及 B 單位	Sky Pool Penthouse
Master Bathroom 主人浴室	Bathtub 浴缸 1600mm(L) (長) x 750mm (W) (闊) x 420mm (H) (高)	—	✓	✓	—
	Free Standing Bathtub 獨立式浴缸 1600mm(L) (長) x 800mm (W) (闊) x 540mm (H) (高)	✓	—	—	—
	Free Standing Bathtub 獨立式浴缸 1690mm(L) (長) x 925mm (W) (闊) x 550mm (H) (高)	—	—	—	✓
	Shower Room 淋浴間	✓	✓	✓	✓
Bathroom 1 浴室1	Bathtub 浴缸 1600mm(L) (長) x 700mm (W) (闊) x 420mm (H) (高)	✓	✓	✓	✓
	Shower Room 淋浴間	—	—	—	—
Bathroom 2 浴室2	Bathtub 浴缸 1600mm(L) (長) x 700mm (W) (闊) x 420mm (H) (高)	—	—	—	—
	Shower Room 淋浴間	✓	✓	✓	✓
Bathroom 3 浴室3	Bathtub 浴缸 1600mm(L) (長) x 700mm (W) (闊) x 420mm (H) (高)	—	—	—	—
	Shower Room 淋浴間	✓	✓	✓	✓
Bathroom 4 浴室4	Bathtub 浴缸 1600mm(L) (長) x 700mm (W) (闊) x 420mm (H) (高)	/	/	/	/
	Shower Room 淋浴間	/	/	/	/

- The symbol “✓” as shown in the above table denotes such appliance(s) is/are provided and/or installed in the residential property.
- The symbol “—” as shown in the above table denotes “Not provided”.
- The symbol “/” as shown in the above table denotes “Not applicable”.
- “Terrace Apartment”, “Garden Apartment” and “Courtyard Penthouse” are names for marketing purposes only and will not appear in any Deed of Mutual Covenant, the Preliminary Agreement for Sale and Purchase, Agreement for Sale and Purchase, Assignment, or any other title deeds and documents relating to the Development. The names as appearing on the approved building plans are: Flat A on 1/F of Tower 1 for Terrace Apartment on 1/F of Tower 1; Flat B on G/F of Tower 2 for Garden Apartment on G/F of Tower 2; Flat B on G/F of Tower 3 for Garden Apartment on G/F of Tower 3; Flat A on G/F of Tower 7 for Garden Apartment on G/F of Tower 7; Penthouse on 11/F of Tower 7 for Courtyard Penthouse on 11/F of Tower 7; Flat B on G/F of Tower 8 for Garden Apartment on G/F of Tower 8; Penthouse on 11/F of Tower 8 for Courtyard Penthouse on 11/F of Tower 8.

- 上表內之「✓」代表此設備於該住宅物業內提供及 / 或安裝。
- 上表內之「—」代表「不提供」。
- 上表內之「/」代表「不適用」。
- 「Terrace Apartment」、「Garden Apartment」及「Courtyard Penthouse」僅為市場推廣之用的名稱，並不會於關於發展項目的任何公契、臨時買賣合約、買賣合約、轉讓契及契據出現。經批准的建築圖則上顯示的名稱為：第 1 座 1 樓 A 單位（即第 1 座 1 樓 Terrace Apartment）；第 2 座地下 B 單位（即第 2 座地下 Garden Apartment）；第 3 座地下 B 單位（即第 3 座地下 Garden Apartment）；第 7 座地下 A 單位（即第 7 座地下 Garden Apartment）；第 7 座 11 樓 Penthouse（即第 7 座 11 樓 Courtyard Penthouse）；第 8 座地下 B 單位（即第 8 座地下 Garden Apartment）；第 8 座 11 樓 Penthouse（即第 8 座 11 樓 Courtyard Penthouse）。

# FITTINGS, FINISHES AND APPLIANCES

## 裝置、裝修物料及設備

### Bathroom Schedule

#### 浴室說明

		Tower 2 第2座					
Location 位置	Floor 樓層	G/F - 1/F 地下至1樓	G/F 地下	2/F - 3/F, 5/F - 9/F 2樓至3樓、5樓至9樓	1/F - 3/F, 5/F - 6/F & 9/F 1樓至3樓、5樓至6樓 及9樓	7/F & 8/F 7樓至8樓	10/F - 11/F 10樓至11樓
	Unit 單位	Garden Duplex	• Garden Apartment	Flat A A 單位	Flat B B 單位	Flat B B 單位	Spa Duplex A & B
Master Bathroom 主人浴室	Bathtub 浴缸 1600mm(L) (長) x 750mm (W) (闊) x 420mm (H) (高)	—	✓	✓	✓	—	—
	Free Standing Bathtub 獨立式浴缸 1600mm(L) (長) x 800mm (W) (闊) x 540mm (H) (高)	—	—	—	—	—	✓
	Free Standing Bathtub 獨立式浴缸 1690mm(L) (長) x 925mm (W) (闊) x 550mm (H) (高)	✓	—	—	—	—	—
	Free Standing Bathtub 獨立式浴缸 1480mm(L) (長) x 730mm (W) (闊) x 575mm (H) (高)	—	—	—	—	✓	—
	Shower Room 淋浴間	✓	✓	✓	✓	✓	✓
Bathroom 1 浴室1	Bathtub 浴缸 1600mm(L) (長) x 700mm (W) (闊) x 420mm (H) (高)	—	—	—	—	—	—
	Shower Room 淋浴間	✓	✓	✓	✓	✓	✓
Bathroom 2 浴室2	Bathtub 浴缸 1600mm(L) (長) x 700mm (W) (闊) x 4 420mm (H) (高)	✓	✓	—	—	—	—
	Shower Room 淋浴間	—	—	✓	✓	✓	✓
Bathroom 3 浴室3	Bathtub 浴缸 1600mm(L) (長) x 700mm (W) (闊) x 420mm (H) (高)	—	—	✓	✓	✓	✓
	Shower Room 淋浴間	✓	✓	—	—	—	—
Bathroom 4 浴室4	Bathtub 浴缸 1600mm(L) (長) x 700mm (W) (闊) x 420mm (H) (高)	—	/	/	/	/	/
	Shower Room 淋浴間	✓	/	/	/	/	/

- The symbol “✓” as shown in the above table denotes such appliance(s) is/are provided and/or installed in the residential property.
- The symbol “—” as shown in the above table denotes “Not provided”.
- The symbol “/” as shown in the above table denotes “Not applicable”.
- “Terrace Apartment”, “Garden Apartment” and “Courtyard Penthouse” are names for marketing purposes only and will not appear in any Deed of Mutual Covenant, the Preliminary Agreement for Sale and Purchase, Agreement for Sale and Purchase, Assignment, or any other title deeds and documents relating to the Development. The names as appearing on the approved building plans are: Flat A on 1/F of Tower 1 for Terrace Apartment on 1/F of Tower 1; Flat B on G/F of Tower 2 for Garden Apartment on G/F of Tower 2; Flat B on G/F of Tower 3 for Garden Apartment on G/F of Tower 3; Flat A on G/F of Tower 7 for Garden Apartment on G/F of Tower 7; Penthouse on 11/F of Tower 7 for Courtyard Penthouse on 11/F of Tower 7; Flat B on G/F of Tower 8 for Garden Apartment on G/F of Tower 8; Penthouse on 11/F of Tower 8 for Courtyard Penthouse on 11/F of Tower 8.

- 上表內之「✓」代表此設備於該住宅物業內提供及 / 或安裝。
- 上表內之「—」代表「不提供」。
- 上表內之「/」代表「不適用」。
- 「Terrace Apartment」、「Garden Apartment」及「Courtyard Penthouse」僅為市場推廣之用的名稱，並不會於關於發展項目的任何公契、臨時買賣合約、買賣合約、轉讓契及契據出現。經批准的建築圖則上顯示的名稱為：第1座1樓A單位（即第1座1樓Terrace Apartment）；第2座地下B單位（即第2座地下Garden Apartment）；第3座地下B單位（即第3座地下Garden Apartment）；第7座地下A單位（即第7座地下Garden Apartment）；第7座11樓Penthouse（即第7座11樓Courtyard Penthouse）；第8座地下B單位（即第8座地下Garden Apartment）；第8座11樓Penthouse（即第8座11樓Courtyard Penthouse）。

## FITTINGS, FINISHES AND APPLIANCES

### 裝置、裝修物料及設備

#### Bathroom Schedule

#### 浴室說明

		Tower 3 第 3 座				
Location 位置	Floor 樓層	G/F - 1/F 地下至1樓	G/F 地下	2/F - 3/F, 5/F - 10/F 2樓至3樓、5樓至10樓	1/F - 3/F, 5/F - 10/F 1樓至3樓、5樓至10樓	11/F 11樓
	Flat 單位	Garden Duplex	• Garden Apartment	Flat A A 單位	Flat B B 單位	Sky Pool Penthouse
Master Bathroom 主人浴室	Bathtub 浴缸 1600mm(L) (長) x 750mm (W) (闊) x 420mm (H) (高)	—	—	✓	✓	—
	Free Standing Bathtub 獨立式浴缸 1600mm(L) (長) x 800mm (W) (闊) x 540mm (H) (高)	✓	✓	—	—	—
	Free Standing Bathtub 獨立式浴缸 1690mm(L) (長) x 925mm (W) (闊) x 550mm (H) (高)	—	—	—	—	✓
	Shower Room 淋浴間	✓	✓	✓	✓	✓
Bathroom 1 浴室1	Bathtub 浴缸 1600mm(L) (長) x 700mm (W) (闊) x 420mm (H) (高)	✓	✓	✓	✓	✓
	Shower Room 淋浴間	—	—	—	—	—
Bathroom 2 浴室2	Bathtub 浴缸 1600mm(L) (長) x 700mm (W) (闊) x 420mm (H) (高)	—	—	—	—	—
	Shower Room 淋浴間	✓	✓	✓	✓	✓
Bathroom 3 浴室3	Bathtub 浴缸 1600mm(L) (長) x 700mm (W) (闊) x 420mm (H) (高)	—	—	—	—	—
	Shower Room 淋浴間	✓	✓	✓	✓	✓
Bathroom 4 浴室4	Bathtub 浴缸 1600mm(L) (長) x 700mm (W) (闊) x 420mm (H) (高)	—	—	—	—	—
	Shower Room 淋浴間	—	—	—	—	—

#### Notes:

- The symbol “✓” as shown in the above table denotes such appliance(s) is/are provided and/or installed in the residential property.
- The symbol “—” as shown in the above table denotes “Not provided”.
- The symbol “—” as shown in the above table denotes “Not applicable”.
- “Terrace Apartment”, “Garden Apartment” and “Courtyard Penthouse” are names for marketing purposes only and will not appear in any Deed of Mutual Covenant, the Preliminary Agreement for Sale and Purchase, Agreement for Sale and Purchase, Assignment, or any other title deeds and documents relating to the Development. The names as appearing on the approved building plans are: Flat A on 1/F of Tower 1 for Terrace Apartment on 1/F of Tower 1; Flat B on G/F of Tower 2 for Garden Apartment on G/F of Tower 2; Flat B on G/F of Tower 3 for Garden Apartment on G/F of Tower 3; Flat A on G/F of Tower 7 for Garden Apartment on G/F of Tower 7; Penthouse on 11/F of Tower 7 for Courtyard Penthouse on 11/F of Tower 7; Flat B on G/F of Tower 8 for Garden Apartment on G/F of Tower 8; Penthouse on 11/F of Tower 8 for Courtyard Penthouse on 11/F of Tower 8.

#### 備註:

- 上表內之「✓」代表此設備於該住宅物業內提供及 / 或安裝。
- 上表內之「—」代表「不提供」。
- 上表內之「—」代表「不適用」。
- 「Terrace Apartment」、「Garden Apartment」及「Courtyard Penthouse」僅為市場推廣之用的名稱，並不會於關於發展項目的任何公契、臨時買賣合約、買賣合約、轉讓契及契據出現。經批准的建築圖則上顯示的名稱為：第 1 座 1 樓 A 單位（即第 1 座 1 樓 Terrace Apartment）；第 2 座地下 B 單位（即第 2 座地下 Garden Apartment）；第 3 座地下 B 單位（即第 3 座地下 Garden Apartment）；第 7 座地下 A 單位（即第 7 座地下 Garden Apartment）；第 7 座 11 樓 Penthouse（即第 7 座 11 樓 Courtyard Penthouse）；第 8 座地下 B 單位（即第 8 座地下 Garden Apartment）；第 8 座 11 樓 Penthouse（即第 8 座 11 樓 Courtyard Penthouse）。



## FITTINGS, FINISHES AND APPLIANCES

### 裝置、裝修物料及設備

#### Bathroom Schedule

#### 浴室說明

Location 位置	Floor 樓層	Tower 5 & 6 第 5 及 6 座		Tower 7 第 7 座		
		1/F - 3/F, 5/F - 10/F 1樓至3樓、5樓至10樓	11/F 11樓	G/F 地下	1/F - 3/F, 5/F - 10/F 1樓至3樓、5樓至10樓	11/F 11樓
	Unit 單位	Flat A & B A 及 B 單位	Sky Pool Penthouse	• Garden Apartment	Flat A & B A 及 B 單位	• Courtyard Penthouse
Master Bathroom 主人浴室	Bathtub 浴缸 1600mm(L) (長) x 750mm (W) (闊) x 420mm (H) (高)	✓	—	✓	✓	—
	Free Standing Bathtub 獨立式浴缸 1600mm(L) (長) x 800mm (W) (闊) x 540mm (H) (高)	—	—	—	—	—
	Free Standing Bathtub 獨立式浴缸 1690mm(L) (長) x 925mm (W) (闊) x 550mm (H) (高)	—	✓	—	—	✓
	Shower Room 淋浴間	✓	✓	✓	✓	✓
Bathroom 1 浴室1	Bathtub 浴缸 1600mm(L) (長) x 700mm (W) (闊) x 420mm (H) (高)	—	✓	—	—	✓
	Shower Room 淋浴間	✓	—	✓	✓	—
Bathroom 2 浴室2	Bathtub 浴缸 1600mm(L) (長) x 700mm (W) (闊) x 420mm (H) (高)	✓	—	✓	✓	—
	Shower Room 淋浴間	—	✓	—	—	✓
Bathroom 3 浴室3	Bathtub 浴缸 1600mm(L) (長) x 700mm (W) (闊) x 420mm (H) (高)	—	—	—	—	—
	Shower Room 淋浴間	—	✓	—	—	✓

#### Notes:

- The symbol “✓” as shown in the above table denotes such appliance(s) is/are provided and/or installed in the residential property.
- The symbol “—” as shown in the above table denotes “Not provided”.
- The symbol “—” as shown in the above table denotes “Not applicable”.
- “Terrace Apartment”, “Garden Apartment” and “Courtyard Penthouse” are names for marketing purposes only and will not appear in any Deed of Mutual Covenant, the Preliminary Agreement for Sale and Purchase, Agreement for Sale and Purchase, Assignment, or any other title deeds and documents relating to the Development. The names as appearing on the approved building plans are: Flat A on 1/F of Tower 1 for Terrace Apartment on 1/F of Tower 1; Flat B on G/F of Tower 2 for Garden Apartment on G/F of Tower 2; Flat B on G/F of Tower 3 for Garden Apartment on G/F of Tower 3; Flat A on G/F of Tower 7 for Garden Apartment on G/F of Tower 7; Penthouse on 11/F of Tower 7 for Courtyard Penthouse on 11/F of Tower 7; Flat B on G/F of Tower 8 for Garden Apartment on G/F of Tower 8; Penthouse on 11/F of Tower 8 for Courtyard Penthouse on 11/F of Tower 8.

#### 備註:

- 上表內之「✓」代表此設備於該住宅物業內提供及 / 或安裝。
- 上表內之「—」代表「不提供」。
- 上表內之「—」代表「不適用」。
- 「Terrace Apartment」、「Garden Apartment」及「Courtyard Penthouse」僅為市場推廣之用的名稱，並不會於關於發展項目的任何公契、臨時買賣合約、買賣合約、轉讓契及契據出現。經批准的建築圖則上顯示的名稱為：第 1 座 1 樓 A 單位（即第 1 座 1 樓 Terrace Apartment）；第 2 座地下 B 單位（即第 2 座地下 Garden Apartment）；第 3 座地下 B 單位（即第 3 座地下 Garden Apartment）；第 7 座地下 A 單位（即第 7 座地下 Garden Apartment）；第 7 座 11 樓 Penthouse（即第 7 座 11 樓 Courtyard Penthouse）；第 8 座地下 B 單位（即第 8 座地下 Garden Apartment）；第 8 座 11 樓 Penthouse（即第 8 座 11 樓 Courtyard Penthouse）。

## FITTINGS, FINISHES AND APPLIANCES

### 裝置、裝修物料及設備

#### Bathroom Schedule

#### 浴室說明

		Tower 8 第 8 座				
Location 位置	Floor 樓層	G/F 地下	1/ F - 7/F, 8/F & 10/F 1樓至7樓、8樓及10樓	9/F 9樓		11/F 11樓
	Unit 單位	• Garden Apartment	Flat A & B A 及 B 單位	Flat A A 單位	Flat B B 單位	• Courtyard Penthouse
Master Bathroom 主人浴室	Bathtub 浴缸 1600mm(L) (長) x 750mm (W) (闊) x 420mm (H) (高)	✓	✓	✓	—	—
	Bathtub 浴缸 1600mm(L) (長) x 914mm (W) (闊) x 559mm (H) (高)	—	—	—	✓	—
	Free Standing Bathtub 獨立式浴缸 1600mm(L) (長) x 800mm (W) (闊) x 540mm (H) (高)	—	—	—	—	—
	Free Standing Bathtub 獨立式浴缸 1690mm(L) (長) x 925mm (W) (闊) x 550mm (H) (高)	—	—	—	—	✓
	Shower Room 淋浴間	✓	✓	✓	✓	✓
Bathroom 1 浴室1	Bathtub 浴缸 1600mm(L) (長) x 700mm (W) (闊) x 420mm (H) (高)	—	—	—	—	✓
	Shower Room 淋浴間	✓	✓	✓	✓	—
Bathroom 2 浴室2	Bathtub 浴缸 1600mm(L) (長) x 700mm (W) (闊) x 420mm (H) (高)	✓	✓	✓	✓	—
	Bathtub 浴缸 1500mm(L) (長) x 820mm (W) (闊) x 560mm (H) (高)	—	—	—	✓	—
	Shower Room 淋浴間	—	—	—	—	✓
Bathroom 3 浴室3	Bathtub 浴缸 1600mm(L) (長) x 700mm (W) (闊) x 420mm (H) (高)	—	—	—	—	—
	Shower Room 淋浴間	—	—	—	—	✓

#### Notes:

- The symbol “✓” as shown in the above table denotes such appliance(s) is/are provided and/or installed in the residential property.
- The symbol “—” as shown in the above table denotes “Not provided”.
- The symbol “/” as shown in the above table denotes “Not applicable”.
- “Terrace Apartment”, “Garden Apartment” and “Courtyard Penthouse” are names for marketing purposes only and will not appear in any Deed of Mutual Covenant, the Preliminary Agreement for Sale and Purchase, Agreement for Sale and Purchase, Assignment, or any other title deeds and documents relating to the Development. The names as appearing on the approved building plans are: Flat A on 1/F of Tower 1 for Terrace Apartment on 1/F of Tower 1; Flat B on G/F of Tower 2 for Garden Apartment on G/F of Tower 2; Flat B on G/F of Tower 3 for Garden Apartment on G/F of Tower 3; Flat A on G/F of Tower 7 for Garden Apartment on G/F of Tower 7; Penthouse on 11/F of Tower 7 for Courtyard Penthouse on 11/F of Tower 7; Flat B on G/F of Tower 8 for Garden Apartment on G/F of Tower 8; Penthouse on 11/F of Tower 8 for Courtyard Penthouse on 11/F of Tower 8.

#### 備註:

- 上表內之「✓」代表此設備於該住宅物業內提供及 / 或安裝。
- 上表內之「—」代表「不提供」。
- 上表內之「/」代表「不適用」。
- 「Terrace Apartment」、「Garden Apartment」及「Courtyard Penthouse」僅為市場推廣之用的名稱，並不會於關於發展項目的任何公契、臨時買賣合約、買賣合約、轉讓契及契據出現。經批准的建築圖則上顯示的名稱為：第 1 座 1 樓 A 單位（即第 1 座 1 樓 Terrace Apartment）；第 2 座地下 B 單位（即第 2 座地下 Garden Apartment）；第 3 座地下 B 單位（即第 3 座地下 Garden Apartment）；第 7 座地下 A 單位（即第 7 座地下 Garden Apartment）；第 7 座 11 樓 Penthouse（即第 7 座 11 樓 Courtyard Penthouse）；第 8 座地下 B 單位（即第 8 座地下 Garden Apartment）；第 8 座 11 樓 Penthouse（即第 8 座 11 樓 Courtyard Penthouse）。

# FITTINGS, FINISHES AND APPLIANCES

## 裝置、裝修物料及設備

### Schedule of Mechanical & Electrical Provisions for Residential Property

#### 住宅單位機電裝置數量說明表

Floor 樓層	Location 位置	Provisions 裝置	House 洋房											
			House 1 1號洋房	House 2 2號洋房	House 3 3號洋房	House 5 5號洋房	House 6 6號洋房	House 7 7號洋房	House 8 8號洋房	House 9 9號洋房	House 10 10號洋房	House 11 11號洋房	House 12 12號洋房	
B/F 地庫	Store Room 1 儲物室1	Single Socket Outlet 單位電插座	1	1	1	1	1	1	1	1	1	1	1	1
		Lighting Switch 燈掣	1	1	1	1	1	1	1	1	1	1	1	1
		Lighting Point 燈位	2	2	3	2	2	2	1	1	1	2	2	
		Fused Spur Unit 保險絲接線位	3	3	3	3	3	3	2	2	2	3	3	
		Switch for AC indoor Unit 空調室內機開關	1	1	1	1	1	1	1	1	1	1	1	
		Miniature Circuit Breaker Board 微型斷路箱	1	1	1	1	1	1	1	1	1	1	1	
		Security System Controller 保安系統控制器	1	1	1	1	1	1	1	1	1	1	1	
		Lift supervisory panel 電梯監控錶板	1	1	1	1	1	1	—	—	—	1	1	
		TV Splitter 電視信號分線器	1	1	1	1	1	1	1	1	1	1	1	
		Door Bell 門鐘	1	1	1	1	1	1	1	1	1	1	1	
	Utility Room 工作間	Twin Socket Outlet 雙位電插座	1	1	1	1	1	1	1	1	1	1	1	
		Lighting Point 燈位	1	1	2	1	1	1	1	1	1	1	1	
		Lighting Switch 燈掣	—	—	1	—	—	—	1	1	1	—	1	
		Water Inlet / Outlet Connection Point for Washing Machine 洗衣機來 / 去水位接駁點	1	1	1	1	1	1	1	1	1	1	1	
	B/F Lift Lobby 地庫電梯大堂	Single Socket Outlet 單位電插座	1	1	1	1	1	1	/	/	/	1	1	
		Lighting Switch 燈掣	3	3	2	3	3	3	/	/	/	3	1	
		Lighting Point 燈位	2	2	3	2	2	2	/	/	/	2	2	
	Protected Lobby 防護門廊	Lighting Point 燈位	2	2	1	2	2	2	2	2	2	2	2	
	Basement Entrance Face to Car Park 面向停車場之 地庫入口	Door Bell Push Button 門鈴按鈕	1	1	1	1	1	1	1	1	1	1	1	
	Lobby 大堂	Lighting Point 燈位	/	/	/	/	/	/	1	1	1	/	/	
		Lighting Switch 燈掣	/	/	/	/	/	/	1	1	1	/	/	

Notes:

1. The symbol “—” as shown in the above table denotes “Not provided”.
2. The symbol “/” as shown in the above table denotes “Not applicable”.

備註:

1. 上表內之「—」代表「不提供」。
2. 上表內之「/」代表「不適用」。

# FITTINGS, FINISHES AND APPLIANCES

## 裝置、裝修物料及設備

### Schedule of Mechanical & Electrical Provisions for Residential Property

#### 住宅單位機電裝置數量說明表

Floor 樓層	Location 位置	Provisions 裝置	House 洋房													
			House 15 15號洋房	House 16 16號洋房	House 17 17號洋房	House 18 18號洋房	House 19 19號洋房	House 20 20號洋房	House 21 21號洋房	House 22 22號洋房	House 23 23號洋房	House 25 25號洋房	House 26 26號洋房	House 27 27號洋房	House 28 28號洋房	
B/F 地庫	Store Room 1 儲物室1	Single Socket Outlet 單位電插座	1	1	1	1	1	1	1	1	1	/	/	/	/	
		Lighting Switch 燈掣	1	1	1	1	1	2	1	1	1	/	/	/	/	
		Lighting Point 燈位	1	1	1	1	1	2	1	1	2	/	/	/	/	
		Fused Spur Unit 保險絲接線位	3	3	3	3	3	3	3	3	3	/	/	/	/	
		Switch for AC indoor Unit 空調室內機開關	1	1	1	1	1	1	1	1	1	/	/	/	/	
		Miniature Circuit Breaker Board 微型斷路箱	1	1	1	1	1	1	1	1	1	/	/	/	/	
		Security System Controller 保安系統控制器	1	1	1	1	1	1	1	1	1	-	/	/	/	/
		Lift supervisory panel 電梯監控錶板	1	1	1	1	1	1	1	1	1	1	/	/	/	/
		TV Splitter 電視信號分線器	1	1	1	1	1	1	1	1	1	1	/	/	/	/
		Door Bell 門鐘	1	1	1	1	1	1	1	1	1	1	/	/	/	/
	Utility Room 工作間	Twin Socket Outlet 雙位電插座	1	1	1	1	1	1	1	1	1	1	/	/	/	/
		Lighting Point 燈位	1	1	1	1	1	1	1	1	1	1	/	/	/	/
		Lighting Switch 燈掣	1	1	1	1	1	1	1	1	1	1	/	/	/	/
		Water Inlet / Outlet Connection Point for Washing Machine 洗衣機來 / 去水位接駁點	1	1	1	1	1	1	1	1	1	1	/	/	/	/
	B/F Lift Lobby 地庫電梯大堂	Single Socket Outlet 單位電插座	1	1	1	1	1	1	1	1	1	1	1	1	1	1
		Lighting Switch 燈掣	2	2	2	2	2	3	2	2	2	2	1	1	1	1
		Lighting Point 燈位	3	3	3	3	2	4	3	3	2	2	1	1	1	1
	Protected Lobby 防護門廊	Lighting Point 燈位	2	2	2	2	2	2	2	2	2	2	2	2	2	2
	Basement Entrance Face to Car Park 面向停車場之 地庫入口	Door Bell Push Button 門鈴按鈕	1	1	1	1	1	1	1	1	1	1	1	1	1	1
	Lobby 大堂	Lighting Point 燈位	/	/	/	/	/	/	/	/	/	/	/	/	/	/
		Lighting Switch 燈掣	/	/	/	/	/	/	/	/	/	/	/	/	/	/

Notes:

- The symbol “ - ” as shown in the above table denotes “Not provided”.
- The symbol “ / ” as shown in the above table denotes “Not applicable”.

備註:

- 上表內之「-」代表「不提供」。
- 上表內之「/」代表「不適用」。

# FITTINGS, FINISHES AND APPLIANCES

## 裝置、裝修物料及設備

### Schedule of Mechanical & Electrical Provisions for Residential Property

#### 住宅單位機電裝置數量說明表

Floor 樓層	Location 位置	Provisions 裝置	House 洋房											
			House 1 1號洋房	House 2 2號洋房	House 3 3號洋房	House 5 5號洋房	House 6 6號洋房	House 7 7號洋房	House 8 8號洋房	House 9 9號洋房	House 10 10號洋房	House 11 11號洋房	House 12 12號洋房	
G/F 地下	Living Room & Dining Room 客廳及飯廳	Single Socket Outlet 單位電插座	1	1	3	1	1	1	1	1	1	2	1	
		Twin Socket Outlet 雙位電插座	4	4	2	4	4	4	3	3	3	4	6	
		Lighting Switch 燈掣	8	8	9	8	8	8	9	9	9	9	9	9
		Lighting Point 燈位	10	10	13	10	10	10	10	10	10	10	8	12
		Exhaust Fan Switch 抽氣扇開關	2	2	2	2	2	2	2	2	2	2	2	2
		Fused Spur Unit 保險絲接線位	—	—	—	—	—	—	—	—	—	—	—	—
		Fused Spur Unit for Motorized Curtain 電動窗簾保險絲電源接線位	2	2	2	2	2	2	2	2	2	2	2	3
		Switch for AC indoor Unit 空調室內機開關	3	3	3	3	3	3	3	3	3	3	3	4
		Telephone Outlet 電話插座	2	2	1	2	2	2	2	2	2	2	2	2
		TV/ FM Outlet 電視 / 電台天線插座	2	2	1	2	2	2	2	2	2	2	2	2
		Door Bell 門鐘	1	1	1	1	1	1	1	1	1	1	1	1
		Siren Bell with Strobe Light 閃燈警報器	—	—	—	—	—	—	—	—	—	—	—	—
		Security System Control Keypad 保安系統鍵盤控制面板	1	1	1	1	1	1	1	1	1	1	1	1
		Door Contact 門磁控感應器	3	3	3	3	3	3	3	3	3	3	4	4
	Window Contact 窗磁控感應器	1	1	1	1	1	1	1	1	1	1	—	—	
	Break Glass Sensor 玻璃破碎感應器	4	4	4	4	4	4	4	3	3	3	4	4	
	Kitchen 廚房	Single Socket Outlet 單位電插座	4	4	4	4	4	4	4	4	4	6	6	
		Twin Socket Outlet 雙位電插座	3	3	3	2	2	2	3	3	3	3	3	
		Lighting Point 燈位	6	6	4	6	6	6	5	5	5	5	5	
		Fused Spur Unit 保險絲接線位	7	7	6	7	7	7	7	7	7	7	7	
		Switch for AC indoor Unit 空調室內機開關	1	1	1	1	1	1	1	1	1	1	1	
		Switch for Oven 焗爐開關掣	1	1	1	1	1	1	1	1	1	1	1	
		Switch for Steamer 蒸爐開關掣	1	1	1	1	1	1	1	1	1	1	1	
		Switch for Induction Cooker 電磁爐開關掣	1	1	1	1	1	1	1	1	1	1	1	
		TV/ FM Outlet 電視 / 電台天線插座	1	1	1	1	1	1	1	1	1	1	1	
		Door Contact 門磁控感應器	1	1	1	—	—	—	—	—	—	—	1	1
Window Contact 窗磁控感應器		—	—	—	1	1	1	1	1	1	—	—		
Siren Bell with Strobe Light 閃燈警報器		1	1	1	1	1	1	1	1	1	1	1		

Notes:

- The symbol “—” as shown in the above table denotes “Not provided”.
- The symbol “/” as shown in the above table denotes “Not applicable”.

備註:

- 上表內之「—」代表「不提供」。
- 上表內之「/」代表「不適用」。



# FITTINGS, FINISHES AND APPLIANCES

## 裝置、裝修物料及設備

### Schedule of Mechanical & Electrical Provisions for Residential Property

#### 住宅單位機電裝置數量說明表

Floor 樓層	Location 位置	Provisions 裝置	House 洋房													
			House 15 15號洋房	House 16 16號洋房	House 17 17號洋房	House 18 18號洋房	House 19 19號洋房	House 20 20號洋房	House 21 21號洋房	House 22 22號洋房	House 23 23號洋房	House 25 25號洋房	House 26 26號洋房	House 27 27號洋房	House 28 28號洋房	
G/F 地下  (UG/F for House 25, 26, 27 & 28 only 上層 地下 只供 25, 26, 27 及 28號洋房)	Living Room & Dining Room 客廳及飯廳  (Living Room for House 20 only 客廳只供20號 洋房)	Single Socket Outlet 單位電插座	1	1	1	1	1	3	1	1	1	1	1	1	1	
		Twin Socket Outlet 雙位電插座	4	4	4	4	4	4	4	4	4	4	4	4	4	4
		Lighting Switch 燈掣	8	8	8	8	8	10	8	8	9	8	8	8	8	8
		Lighting Point 燈位	9	9	9	9	9	21	9	9	11	10	10	10	10	10
		Exhaust Fan Switch 抽氣扇開關	2	2	2	2	2	2	2	2	2	2	2	2	2	2
		Fused Spur Unit 保險絲接線位	1	1	1	1	1	—	1	1	—	—	—	—	—	—
		Fused Spur Unit for Motorized Curtain 電動窗簾保險絲電源接線位	2	2	2	2	2	1	2	2	3	3	3	3	3	3
		Switch for AC indoor Unit 空調室內機開關	3	3	3	3	3	3	3	3	4	3	3	3	3	3
		Telephone Outlet 電話插座	2	2	2	2	2	1	2	2	3	2	2	2	2	2
		TV/ FM Outlet 電視 / 電台天線插座	2	2	2	2	2	1	2	2	3	2	2	2	2	2
		Door Bell 門鐘	1	1	1	1	1	1	1	1	1	1	1	1	1	1
		Siren Bell with Strobe Light 閃燈警報器	—	—	—	—	—	—	—	—	—	—	—	—	—	—
		Security System Control Keypad 保安系統鍵盤控制面板	1	1	1	1	1	1	1	1	—	1	1	1	1	1
		Door Contact 門磁控感應器	3	3	3	3	3	3	3	3	—	4	4	4	4	4
	Window Contact 窗磁控感應器	1	1	1	1	1	1	1	1	—	—	—	—	—	—	
	Break Glass Sensor 玻璃破碎感應器	4	4	4	4	4	4	4	4	—	5	5	5	5	5	
	Kitchen 廚房	Single Socket Outlet 單位電插座	4	4	4	4	4	4	4	4	5	4	4	4	4	4
		Twin Socket Outlet 雙位電插座	3	3	3	3	3	3	3	3	3	2	2	2	2	2
		Lighting Point 燈位	6	6	6	6	6	4	6	6	8	4	4	4	4	4
		Fused Spur Unit 保險絲接線位	7	7	7	7	7	4	7	7	7	7	7	7	7	7
		Switch for AC indoor Unit 空調室內機開關	1	1	1	1	1	1	1	1	1	1	1	1	1	1
		Switch for Oven 焗爐開關掣	1	1	1	1	1	1	1	1	1	1	1	1	1	1
		Switch for Steamer 蒸爐開關掣	1	1	1	1	1	1	1	1	1	1	1	1	1	1
		Switch for Induction Cooker 電磁爐開關掣	1	1	1	1	1	1	1	1	1	1	1	1	1	1
		TV/ FM Outlet 電視 / 電台天線插座	1	1	1	1	1	1	1	1	1	1	1	1	1	1
		Door Contact 門磁控感應器	1	1	1	1	1	1	1	1	—	—	—	—	—	—
Window Contact 窗磁控感應器		—	—	—	—	—	—	—	—	—	—	1	1	1	1	
Siren Bell with Strobe Light 閃燈警報器		1	1	1	1	1	1	1	1	1	—	1	1	1	1	

Notes:

- The symbol “ — ” as shown in the above table denotes “Not provided”.
- The symbol “ / ” as shown in the above table denotes “Not applicable”.

備註:

- 上表內之「—」代表「不提供」。
- 上表內之「/」代表「不適用」。

# FITTINGS, FINISHES AND APPLIANCES

## 裝置、裝修物料及設備

### Schedule of Mechanical & Electrical Provisions for Residential Property

#### 住宅單位機電裝置數量說明表

Floor 樓層	Location 位置	Provisions 裝置	House 洋房													
			House 1 1號洋房	House 2 2號洋房	House 3 3號洋房	House 5 5號洋房	House 6 6號洋房	House 7 7號洋房	House 8 8號洋房	House 9 9號洋房	House 10 10號洋房	House 11 11號洋房	House 12 12號洋房			
G/F 地下	Kitchen 廚房	Break Glass Sensor 玻璃破碎感應器	1	1	1	1	1	1	1	1	1	1	2	1		
		Air-conditioner Central Controller 冷氣中央控制器	1	1	1	1	1	1	1	1	1	1	1	1	1	
		Gas Water Heater Remote Controller 煤氣熱水爐恆溫掣	1	1	1	1	1	1	1	1	1	1	1	1	1	
		Video Doorphone 視像對講機	1	1	1	1	1	1	1	1	1	1	1	1	1	
		Town Gas Connection Point 煤氣接駁點	1	1	1	1	1	1	1	1	1	1	1	1	1	
		Town Gas Meter 煤氣計量錶	1	1	1	1	1	1	1	1	1	1	1	1	1	
		Water Inlet / Outlet Connection Point for Dish Washer 洗碗碟機來 / 去水位接駁點	—	—	—	—	—	—	—	—	—	—	—	1	1	
	Store Room with Lavatory 儲物室及洗手間	Single Socket Outlet 單位電插座	—	—	—	—	—	—	—	—	—	—	—	—	—	
		Twin Socket Outlet 雙位電插座	—	—	—	—	—	—	—	—	—	—	—	—	—	
		Lighting Switch 燈掣	1	1	1	1	1	1	1	1	1	1	1	1	1	
		Lighting Point 燈位	2	2	2	2	2	2	2	2	2	2	2	2	2	
		Exhaust Fan Switch 抽氣扇開關	1	1	1	1	1	1	1	1	1	1	1	1	1	
		Fused Spur Unit 保險絲接線位	1	1	1	1	1	1	1	1	1	1	1	1	1	
		Miniature Circuit Breaker Board 微型斷路箱	—	—	—	—	—	—	—	—	—	—	—	—	—	—
		Lift supervisory panel 電梯監控錶板	—	—	—	—	—	—	—	—	—	—	—	—	—	—
		Security System Controller 保安系統控制器	—	—	—	—	—	—	—	—	—	—	—	—	—	—
		TV Splitter 電視信號分線器	—	—	—	—	—	—	—	—	—	—	—	—	—	—
		Door Bell 門鐘	—	—	—	—	—	—	—	—	—	—	—	—	—	—
		Water Inlet / Outlet Connection Point for Washing Machine 洗衣機來 / 去水位接駁點	—	—	—	—	—	—	—	—	—	—	—	—	—	—
	Utility Room 2 工作間 2	Single Socket Outlet 單位電插座	—	—	—	—	—	—	—	—	—	—	—	—	—	
		Lighting Switch 燈掣	—	—	—	—	—	—	—	—	—	—	—	—	—	
		Exhaust Fan Switch 抽氣扇開關	—	—	—	—	—	—	—	—	—	—	—	—	—	
		Lighting Point 燈位	—	—	—	—	—	—	—	—	—	—	—	—	—	
		Switch for AC indoor Unit 空調室內機開關	—	—	—	—	—	—	—	—	—	—	—	—	—	

Notes:

1. The symbol “—” as shown in the above table denotes “Not provided”.
2. The symbol “/” as shown in the above table denotes “Not applicable”.

備註:

1. 上表內之「—」代表「不提供」。
2. 上表內之「/」代表「不適用」。

# FITTINGS, FINISHES AND APPLIANCES

## 裝置、裝修物料及設備

### Schedule of Mechanical & Electrical Provisions for Residential Property

#### 住宅單位機電裝置數量說明表

Floor 樓層	Location 位置	Provisions 裝置	House 洋房														
			House 15 15號洋房	House 16 16號洋房	House 17 17號洋房	House 18 18號洋房	House 19 19號洋房	House 20 20號洋房	House 21 21號洋房	House 22 22號洋房	House 23 23號洋房	House 25 25號洋房	House 26 26號洋房	House 27 27號洋房	House 28 28號洋房		
G/F 地下 (UG/F for House 25, 26, 27 & 28 only 上層 地下 只供 25, 26, 27 及 28號洋房)	Kitchen 廚房	Break Glass Sensor 玻璃破碎感應器	1	1	1	1	1	1	1	1	1	—	1	1	1	1	
		Air-conditioner Central Controller 冷氣中央控制器	1	1	1	1	1	1	1	1	1	1	—	—	—	—	
		Gas Water Heater Remote Controller 煤氣熱水爐恆溫掣	1	1	1	1	1	1	1	1	1	1	1	1	1	1	1
		Video Doorphone 視像對講機	1	1	1	1	1	1	1	1	1	1	1	1	1	1	1
		Town Gas Connection Point 煤氣接駁點	1	1	1	1	1	1	1	1	1	1	1	1	1	1	1
		Town Gas Meter 煤氣計量錶	1	1	1	1	1	1	1	1	1	1	1	1	1	—	1
		Water Inlet / Outlet Connection Point for Dish Washer 洗碗碟機來 / 去水位接駁點	—	—	—	—	—	—	—	—	—	—	1	—	—	—	—
	Store Room with Lavatory 儲物室及洗手間	Single Socket Outlet 單位電插座	—	—	—	—	—	—	—	—	—	—	—	—	—	—	—
		Twin Socket Outlet 雙位電插座	—	—	—	—	—	—	—	—	—	—	—	—	—	—	—
		Lighting Switch 燈掣	1	1	1	1	1	1	1	1	1	1	—	—	—	—	—
		Lighting Point 燈位	2	2	2	2	2	2	2	2	2	2	—	—	—	—	—
		Exhaust Fan Switch 抽氣扇開關	1	1	1	1	1	1	1	1	1	1	—	—	—	—	—
		Fused Spur Unit 保險絲接線位	1	1	1	1	1	1	1	1	1	1	—	—	—	—	—
		Miniature Circuit Breaker Board 微型斷路箱	—	—	—	—	—	—	—	—	—	—	—	—	—	—	—
		Lift supervisory panel 電梯監控錶板	—	—	—	—	—	—	—	—	—	—	—	—	—	—	—
		Security System Controller 保安系統控制器	—	—	—	—	—	—	—	—	—	—	—	—	—	—	—
		TV Splitter 電視信號分線器	—	—	—	—	—	—	—	—	—	—	—	—	—	—	—
		Door Bell 門鐘	—	—	—	—	—	—	—	—	—	—	—	—	—	—	—
	Water Inlet / Outlet Connection Point for Washing Machine 洗衣機來 / 去水位接駁點	—	—	—	—	—	—	—	—	—	—	—	—	—	—	—	
	Utility Room 2 工作間 2	Single Socket Outlet 單位電插座	—	—	—	—	—	—	—	—	—	—	1	—	—	—	—
Lighting Switch 燈掣		—	—	—	—	—	—	—	—	—	—	2	—	—	—	—	
Exhaust Fan Switch 抽氣扇開關		—	—	—	—	—	—	—	—	—	—	1	—	—	—	—	
Lighting Point 燈位		—	—	—	—	—	—	—	—	—	—	1	—	—	—	—	
Switch for AC indoor Unit 空調室內機開關		—	—	—	—	—	—	—	—	—	—	1	—	—	—	—	

Notes:

- The symbol “—” as shown in the above table denotes “Not provided”.
- The symbol “” as shown in the above table denotes “Not applicable”.

備註:

- 上表內之「—」代表「不提供」。
- 上表內之「」代表「不適用」。

FITTINGS, FINISHES AND APPLIANCES

裝置、裝修物料及設備

Schedule of Mechanical & Electrical Provisions for Residential Property

住宅單位機電裝置數量說明表

Floor 樓層	Location 位置	Provisions 裝置	House 洋房															
			House 1 1號洋房	House 2 2號洋房	House 3 3號洋房	House 5 5號洋房	House 6 6號洋房	House 7 7號洋房	House 8 8號洋房	House 9 9號洋房	House 10 10號洋房	House 11 11號洋房	House 12 12號洋房					
G/F 地下	Utility Room with Lavatory 工作間及洗手間	Single Socket Outlet 單位電插座	/	/	/	/	/	/	/	/	/	/	/	/	/	/		
		Twin Socket Outlet 雙位電插座	/	/	/	/	/	/	/	/	/	/	/	/	/	/	/	
		Lighting Switch 燈掣	/	/	/	/	/	/	/	/	/	/	/	/	/	/	/	
		Lighting Point 燈位	/	/	/	/	/	/	/	/	/	/	/	/	/	/	/	
		Exhaust Fan Switch 抽氣扇開關	/	/	/	/	/	/	/	/	/	/	/	/	/	/	/	
		Fused Spur Unit 保險絲接線位	/	/	/	/	/	/	/	/	/	/	/	/	/	/	/	
		Miniature Circuit Breaker Board 微型斷路箱	/	/	/	/	/	/	/	/	/	/	/	/	/	/	/	
		Lift supervisory panel 電梯監控錶板	/	/	/	/	/	/	/	/	/	/	/	/	/	/	/	
		Security System Controller 保安系統控制器	/	/	/	/	/	/	/	/	/	/	/	/	/	/	/	
		TV Splitter 電視信號分線器	/	/	/	/	/	/	/	/	/	/	/	/	/	/	/	
		Door Bell 門鐘	/	/	/	/	/	/	/	/	/	/	/	/	/	/	/	
		Water Inlet / Outlet Connection Point for Washing Machine 洗衣機來 / 去水位接駁點	/	/	/	/	/	/	/	/	/	/	/	/	/	/	/	
	Garden 花園	Switch for Filtration Plant 泳池過濾系統開關	-	-	-	-	-	-	-	-	-	-	-	-	-	-	-	
		Underwater Lighting in Swimming Pool 泳池水下燈	-	-	-	-	-	-	-	-	-	-	-	-	-	-	-	
		Water Inlet Connection Point for Swimming Pool Filtration Cabinet 游泳池過濾櫃來水位接駁點	-	-	-	-	-	-	-	-	-	-	-	-	-	-	-	
		Water Outlet Connection Point for Swimming Pool Filtration Cabinet 游泳池過濾櫃去水位接駁點	-	-	-	-	-	-	-	-	-	-	-	-	-	-	-	
		Single Waterproof Socket Outlet 防水單位電插座	2	2	-	2	2	2	2	2	2	2	2	2	3			
		Outdoor Wall Mounted Light 戶外掛牆照明燈	11	8	3	7	7	7	8	6	6	4	13					
		Outdoor LED Strip (along pool scum drain channel) 戶外發光二極管燈帶 (沿池邊去水渠)	-	-	-	-	-	-	-	-	-	-	-	-	-	-	-	-
		Video Doorphone 視像對講機	1	1	1	1	1	1	1	1	1	1	1	1	1	1	1	1
		Motion Sensor 移動感測器	3	2	2	2	2	2	2	2	2	2	3	3				
	Utility Room 3 工作間 3	Twin Socket Outlet 雙位電插座	/	/	/	/	/	/	/	/	/	/	/	/	/	/	/	
		Lighting Point 燈位	/	/	/	/	/	/	/	/	/	/	/	/	/	/	/	
		Lighting Switch 燈掣	/	/	/	/	/	/	/	/	/	/	/	/	/	/	/	
		Switch for AC indoor Unit 空調室內機開關	/	/	/	/	/	/	/	/	/	/	/	/	/	/	/	
	Powder Room 客廳洗手間	Lighting Point 燈位	2	2	1	2	2	2	1	1	1	2	2					
		Fused Spur Unit 保險絲接線位	3	3	2	3	3	3	3	3	3	3	3	3				

Notes:

- The symbol “-” as shown in the above table denotes “Not provided”.
- The symbol “/” as shown in the above table denotes “Not applicable”.

備註:

- 上表內之“-”代表「不提供」。
- 上表內之“/”代表「不適用」。

FITTINGS, FINISHES AND APPLIANCES

裝置、裝修物料及設備

Schedule of Mechanical & Electrical Provisions for Residential Property

住宅單位機電裝置數量說明表

Floor 樓層	Location 位置	Provisions 裝置	House 洋房														
			House 15 15號洋房	House 16 16號洋房	House 17 17號洋房	House 18 18號洋房	House 19 19號洋房	House 20 20號洋房	House 21 21號洋房	House 22 22號洋房	House 23 23號洋房	House 25 25號洋房	House 26 26號洋房	House 27 27號洋房	House 28 28號洋房		
G/F 地下  (UG/F for House 25, 26, 27 & 28 only 上層 地下 只供 25, 26, 27 及 28號洋房)	Utility Room with Lavatory 工作間及洗手間	Single Socket Outlet 單位電插座	/	/	/	/	/	/	/	/	/	/	1	1	1	1	
		Twin Socket Outlet 雙位電插座	/	/	/	/	/	/	/	/	/	/	/	1	1	1	1
		Lighting Switch 燈掣	/	/	/	/	/	/	/	/	/	/	/	2	2	2	2
		Lighting Point 燈位	/	/	/	/	/	/	/	/	/	/	/	2	2	2	2
		Exhaust Fan Switch 抽氣扇開關	/	/	/	/	/	/	/	/	/	/	/	1	1	1	1
		Switch for A/C Indoor Unit 空調室內機開關	/	/	/	/	/	/	/	/	/	/	/	1	1	1	1
		Air-conditioner Central Controller 冷氣中央控制器	/	/	/	/	/	/	/	/	/	/	/	1	1	1	1
		Fused Spur Unit 保險絲接線位	/	/	/	/	/	/	/	/	/	/	/	3	3	3	3
		Miniature Circuit Breaker Board 微型斷路箱	/	/	/	/	/	/	/	/	/	/	/	1	1	1	1
		Lift supervisory panel 電梯監控錶板	/	/	/	/	/	/	/	/	/	/	/	1	1	1	1
		Security System Controller 保安系統控制器	/	/	/	/	/	/	/	/	/	/	/	1	1	1	1
		TV Splitter 電視信號分線器	/	/	/	/	/	/	/	/	/	/	/	1	1	1	1
		Door Bell 門鐘	/	/	/	/	/	/	/	/	/	/	/	1	1	1	1
		Water Inlet / Outlet Connection Point for Washing Machine 洗衣機來 / 去水位接駁點	/	/	/	/	/	/	/	/	/	/	/	1	1	1	1
	Garden 花園	Switch for Filtration Plant 泳池過濾系統開關	/	/	/	/	/	/	/	1	1	1	1	/	/	/	/
		Underwater Lighting in Swimming Pool 泳池水下燈	/	/	/	/	/	/	/	10	10	10	13	/	/	/	/
		Water Inlet Connection Point for Swimming Pool Filtration Cabinet 游泳池過濾櫃來水位接駁點	/	/	/	/	/	/	/	1	1	1	1	/	/	/	/
		Water Outlet Connection Point for Swimming Pool Filtration Cabinet 游泳池過濾櫃去水位接駁點	/	/	/	/	/	/	/	2	2	2	2	/	/	/	/
		Single Waterproof Socket Outlet 防水單位電插座	2	2	2	2	2	2	2	2	2	2	4	2	2	2	2
		Outdoor Wall Mounted Light 戶外掛牆照明燈	9	10	12	14	14	6	11	11	16	6	6	6	6	6	6
		Outdoor LED Light Strip (along Pool Scum Drain Channel) 戶外發光二極管燈帶(沿池邊去水渠)	/	/	/	/	/	/	/	/	/	/	1	/	/	/	/
		Town Gas Meter 煤氣計量錶	-	-	-	-	-	-	-	-	-	-	-	-	-	1	-
		Video Doorphone 視像對講機	1	1	1	1	1	1	1	1	1	1	1	1	1	1	1
		Motion Sensor 移動感測器	2	2	2	2	2	2	2	2	2	-	2	2	2	2	2
	Utility Room 3 工作間 3	Twin Socket Outlet 雙位電插座	/	/	/	/	/	/	/	/	/	1	/	/	/	/	
		Lighting Point 燈位	/	/	/	/	/	/	/	/	/	1	/	/	/	/	
		Lighting Switch 燈掣	/	/	/	/	/	/	/	/	/	1	/	/	/	/	
		Switch for AC indoor Unit 空調室內機開關	/	/	/	/	/	/	/	/	/	1	/	/	/	/	
Powder Room 客廳洗手間	Lighting Point 燈位	2	2	2	2	2	2	2	2	2	2	2	2	2	2		
	Fused Spur Unit 保險絲接線位	3	3	3	3	3	3	1	3	3	3	3	3	3	3		

Notes:

- The symbol “ - ” as shown in the above table denotes “Not provided”.
- The symbol “ / ” as shown in the above table denotes “Not applicable”.

備註:

- 上表內之「-」代表「不提供」。
- 上表內之「/」代表「不適用」。



# FITTINGS, FINISHES AND APPLIANCES

## 裝置、裝修物料及設備

### Schedule of Mechanical & Electrical Provisions for Residential Property

#### 住宅單位機電裝置數量說明表

Floor 樓層	Location 位置	Provisions 裝置	House 洋房											
			House 1 1號洋房	House 2 2號洋房	House 3 3號洋房	House 5 5號洋房	House 6 6號洋房	House 7 7號洋房	House 8 8號洋房	House 9 9號洋房	House 10 10號洋房	House 11 11號洋房	House 12 12號洋房	
1/F 1樓	Dining Room 飯廳	Single Socket Outlet 單位電插座	/	/	/	/	/	/	/	/	/	/	/	
		Twin Socket Outlet 雙位電插座	/	/	/	/	/	/	/	/	/	/	/	
		Lighting Switch 燈掣	/	/	/	/	/	/	/	/	/	/	/	
		Lighting Point 燈位	/	/	/	/	/	/	/	/	/	/	/	
		Switch for AC indoor Unit 空調室內機開關	/	/	/	/	/	/	/	/	/	/	/	
		Exhaust Fan Switch 抽氣扇開關	/	/	/	/	/	/	/	/	/	/	/	
	Master Bedroom 1 主人睡房1	Twin Socket Outlet 雙位電插座	3	3	3	3	3	3	3	3	3	3	3	
		Lighting Switch 燈掣	3	3	6	3	3	3	2	2	2	3	2	
		Lighting Point 燈位	2	2	11	2	2	2	2	2	2	3	2	
		Switch for AC indoor Unit 空調室內機開關	1	1	1	1	1	1	1	1	1	1	1	
		Fused Spur Unit for Motorized Curtain 電動窗簾保險絲電源接線位	1	1	1	1	1	1	1	1	1	1	1	
		TV/ FM Outlet 電視 / 電台天線插座	2	2	1	2	2	2	2	2	2	2	2	
		Telephone Outlet 電話插座	2	2	1	2	2	2	2	2	2	2	2	
		Panic Alarm Button 警鐘系統按鈕	1	1	1	1	1	1	1	1	1	1	1	
	Flat Roof for Dining Room 飯廳平台	Lighting Point 燈位	/	/	/	/	/	/	/	/	/	/	/	
	Flat Roof for Master Bedroom 1 主人睡房1平台	Lighting Point 燈位	1	1	1	1	1	1	/	/	/	/	/	
	Master Bathroom 1 主人浴室1	Single Socket Outlet 單位電插座	1	1	2	1	1	1	1	1	1	1	1	
		Twin Socket Outlet 雙位電插座	1	1	-	1	1	1	1	1	1	1	1	
		Lighting Point 燈位	5	5	4	5	5	5	6	6	6	4	6	
		Fused Spur Unit 保險絲接線位	2	2	2	2	2	2	2	2	2	2	3	
		Fused Spur Unit for Motorized Curtain 電動窗簾保險絲電源接線位	-	-	-	-	-	-	1	1	1	-	2	
		Switch For Thermal Ventilator 浴室寶開關	1	1	-	1	1	1	1	1	1	1	1	
		TV/ FM Outlet 電視 / 電台天線插座	1	1	1	1	1	1	1	1	1	1	1	
		Gas Water Heater Remote Controller 煤氣熱水爐恆溫掣	1	1	1	1	1	1	1	1	1	1	1	
	Powder Room 客廳洗手間	Gas Water Heater Remote Controller 煤氣熱水爐恆溫掣	/	/	/	/	/	/	/	/	/	/	/	
		Lighting Point 燈位	/	/	/	/	/	/	/	/	/	/	/	
	Balcony for Master Bedroom 1 主人睡房1露台	Lighting Point 燈位	/	/	/	/	/	/	/	/	/	1	/	

Notes:

- The symbol “ - ” as shown in the above table denotes “Not provided”.
- The symbol “ / ” as shown in the above table denotes “Not applicable”.

備註:

- 上表內之「-」代表「不提供」。
- 上表內之「/」代表「不適用」。

FITTINGS, FINISHES AND APPLIANCES

裝置、裝修物料及設備

Schedule of Mechanical & Electrical Provisions for Residential Property

住宅單位機電裝置數量說明表

Floor 樓層	Location 位置	Provisions 裝置	House 洋房														
			House 15 15號洋房	House 16 16號洋房	House 17 17號洋房	House 18 18號洋房	House 19 19號洋房	House 20 20號洋房	House 21 21號洋房	House 22 22號洋房	House 23 23號洋房	House 25 25號洋房	House 26 26號洋房	House 27 27號洋房	House 28 28號洋房		
1/F 1樓	Dining Room 飯廳	Single Socket Outlet 單位電插座	/	/	/	/	/	/	3	/	/	/	/	/	/	/	
		Twin Socket Outlet 雙位電插座	/	/	/	/	/	/	1	/	/	/	/	/	/	/	
		Lighting Switch 燈掣	/	/	/	/	/	/	/	5	/	/	/	/	/	/	/
		Lighting Point 燈位	/	/	/	/	/	/	/	12	/	/	/	/	/	/	/
		Switch for AC indoor Unit 空調室內機開關	/	/	/	/	/	/	/	2	/	/	/	/	/	/	/
		Exhaust Fan Switch 抽氣扇開關	/	/	/	/	/	/	/	1	/	/	/	/	/	/	/
	Master Bedroom 1 主人睡房1	Twin Socket Outlet 雙位電插座	3	3	3	3	3	3	3	3	3	3	3	3	3	3	3
		Lighting Switch 燈掣	3	3	3	3	3	3	3	3	3	3	3	3	3	3	3
		Lighting Point 燈位	4	4	4	4	4	4	2	4	4	3	2	2	2	2	2
		Switch for AC indoor Unit 空調室內機開關	1	1	1	1	1	1	1	1	1	1	1	1	1	1	1
		Fused Spur Unit for Motorized Curtain 電動窗簾保險絲電源接線位	1	1	1	1	1	1	1	1	1	1	1	1	1	1	1
		TV/ FM Outlet 電視 / 電台天線插座	2	2	2	2	2	2	2	2	2	2	2	2	2	2	2
		Telephone Outlet 電話插座	2	2	2	2	2	2	2	2	2	2	2	2	2	2	2
	Panic Alarm Button 警鐘系統按鈕	1	1	1	1	1	1	1	1	1	1	—	1	1	1	1	
	Flat Roof for Dining Room 飯廳平台	Lighting Point 燈位	/	/	/	/	/	/	1	/	/	/	/	/	/	/	
	Flat Roof for Master Bedroom 1 主人睡房1平台	Lighting Point 燈位	1	1	1	1	1	1	1	1	1	3	1	1	1	1	
	Master Bathroom 1 主人浴室1	Single Socket Outlet 單位電插座	1	1	1	1	1	1	1	1	1	1	1	1	1	1	1
		Twin Socket Outlet 雙位電插座	1	1	1	1	1	1	1	1	1	1	1	1	1	1	1
		Lighting Point 燈位	6	6	6	6	6	6	6	6	6	4	5	5	5	5	5
		Fused Spur Unit 保險絲接線位	2	2	2	2	2	2	2	2	2	2	2	2	2	2	2
		Fused Spur Unit for Motorized Curtain 電動窗簾保險絲電源接線位	—	—	—	—	—	—	—	—	—	1	—	—	—	—	—
		Switch For Thermal Ventilator 浴室寶開關	1	1	1	1	1	1	1	1	1	1	1	1	1	1	1
		TV/ FM Outlet 電視 / 電台天線插座	1	1	1	1	1	1	1	1	1	1	1	1	1	1	1
		Gas Water Heater Remote Controller 煤氣熱水爐恆溫掣	1	1	1	1	1	1	1	1	1	1	1	1	1	1	1
	Powder Room 客廳洗手間	Gas Water Heater Remote Controller 煤氣熱水爐恆溫掣	/	/	/	/	/	/	/	1	/	/	/	/	/	/	/
		Fused Spur Unit 保險絲接線位	/	/	/	/	/	/	/	2	/	/	/	/	/	/	/
		Lighting Point 燈位	/	/	/	/	/	/	/	3	/	/	/	/	/	/	/
	Balcony for Master Bedroom 1 主人睡房1露台	Lighting Point 燈位	/	/	/	/	/	/	/	/	/	/	/	/	/	/	/

Notes:

- The symbol “ — ” as shown in the above table denotes “Not provided”.
- The symbol “ / ” as shown in the above table denotes “Not applicable”.

備註:

- 上表內之「—」代表「不提供」。
- 上表內之「/」代表「不適用」。

# FITTINGS, FINISHES AND APPLIANCES

## 裝置、裝修物料及設備

### Schedule of Mechanical & Electrical Provisions for Residential Property

#### 住宅單位機電裝置數量說明表

Floor 樓層	Location 位置	Provisions 裝置	House 洋房											
			House 1 1號洋房	House 2 2號洋房	House 3 3號洋房	House 5 5號洋房	House 6 6號洋房	House 7 7號洋房	House 8 8號洋房	House 9 9號洋房	House 10 10號洋房	House 11 11號洋房	House 12 12號洋房	
1/F 1樓	Master Bedroom 2 主人睡房 2	Twin Socket Outlet 雙位電插座	/	/	/	/	/	/	/	/	/	/	/	
		Lighting Switch 燈掣	/	/	/	/	/	/	/	/	/	/	/	
		Lighting Point 燈位	/	/	/	/	/	/	/	/	/	/	/	
		Switch for AC indoor Unit 空調室內機開關	/	/	/	/	/	/	/	/	/	/	/	
		Fused Spur Unit for Motorized Curtain 電動窗簾保險絲電源接線位	/	/	/	/	/	/	/	/	/	/	/	
		Telephone Outlet 電話插座	/	/	/	/	/	/	/	/	/	/	/	
		TV/ FM Outlet 電視 / 電台天線插座	/	/	/	/	/	/	/	/	/	/	/	
		Panic Alarm Button 警鐘系統按鈕	/	/	/	/	/	/	/	/	/	/	/	
	Master Bathroom 2 主人浴室 2	Single Socket Outlet 單位電插座	/	/	/	/	/	/	/	/	/	/	/	
		Twin Socket Outlet 雙位電插座	/	/	/	/	/	/	/	/	/	/	/	
		Lighting Point 燈位	/	/	/	/	/	/	/	/	/	/	/	
		Fused Spur Unit 保險絲接線位	/	/	/	/	/	/	/	/	/	/	/	
		Fused Spur Unit for Motorized Curtain 電動窗簾保險絲電源接線位	/	/	/	/	/	/	/	/	/	/	/	
		Switch For Thermal Ventilator 浴室寶開關	/	/	/	/	/	/	/	/	/	/	/	
		TV/ FM Outlet 電視 / 電台天線插座	/	/	/	/	/	/	/	/	/	/	/	
		Gas Water Heater Remote Controller 煤氣熱水爐恆溫掣	/	/	/	/	/	/	/	/	/	/	/	
	Ensuite 1 套房 1	Twin Socket Outlet 雙位電插座	3	3	1	3	3	3	3	3	3	3	3	
		Single Socket Outlet 單位電插座	—	—	1	—	—	—	—	—	—	—	—	
		Lighting Switch 燈掣	2	2	2	2	2	2	3	3	3	3	2	
		Lighting Point 燈位	1	1	4	1	1	1	2	2	2	2	1	
		Switch for AC indoor Unit 空調室內機開關	1	1	1	1	1	1	1	1	1	1	1	
		Exhaust Fan Switch 抽氣扇開關	1	1	1	1	1	1	1	1	1	1	1	
		Telephone Outlet 電話插座	1	1	1	1	1	1	1	1	1	1	1	
		TV/ FM Outlet 電視 / 電台天線插座	1	1	—	1	1	1	1	1	1	1	1	
	Balcony fo Ensuite 1 睡房1平台	Lighting Point 燈位	/	/	/	/	/	/	3	3	3	2	/	
	Bathroom 1 浴室1	Twin Socket Outlet 雙位電插座	1	1	—	1	1	1	1	1	1	1	1	
		Single Socket Outlet 單位電插座	/	/	1	/	/	/	/	/	/	/	/	
		Lighting Point 燈位	3	3	1	3	3	3	3	3	3	3	3	
		Fused Spur Unit 保險絲接線位	3	3	2	3	3	3	3	3	3	3	3	
		Gas Water Heater Remote Controller 煤氣熱水爐恆溫掣	1	1	1	1	1	1	1	1	1	1	1	
Balcony fo Ensuite 1 套房露台1	Lighting Point 燈位	/	/	/	/	/	/	/	/	/	/	/		

Notes:

1. The symbol “—” as shown in the above table denotes “Not provided”.
2. The symbol “/” as shown in the above table denotes “Not applicable”.

備註:

1. 上表內之「—」代表「不提供」。
2. 上表內之「/」代表「不適用」。

# FITTINGS, FINISHES AND APPLIANCES

## 裝置、裝修物料及設備

### Schedule of Mechanical & Electrical Provisions for Residential Property

#### 住宅單位機電裝置數量說明表

Floor 樓層	Location 位置	Provisions 裝置	House 洋房													
			House 15 15號洋房	House 16 16號洋房	House 17 17號洋房	House 18 18號洋房	House 19 19號洋房	House 20 20號洋房	House 21 21號洋房	House 22 22號洋房	House 23 23號洋房	House 25 25號洋房	House 26 26號洋房	House 27 27號洋房	House 28 28號洋房	
1/F 1樓	Master Bedroom 2 主人睡房 2	Twin Socket Outlet 雙位電插座	/	/	/	/	/	/	/	/	/	1	/	/	/	/
		Lighting Switch 燈掣	/	/	/	/	/	/	/	/	/	2	/	/	/	/
		Lighting Point 燈位	/	/	/	/	/	/	/	/	/	3	/	/	/	/
		Switch for AC indoor Unit 空調室內機開關	/	/	/	/	/	/	/	/	/	1	/	/	/	/
		Fused Spur Unit for Motorized Curtain 電動窗簾保險絲電源接線位	/	/	/	/	/	/	/	/	/	-	/	/	/	/
		Telephone Outlet 電話插座	/	/	/	/	/	/	/	/	/	2	/	/	/	/
		TV/ FM Outlet 電視 / 電台天線插座	/	/	/	/	/	/	/	/	/	2	/	/	/	/
		Panic Alarm Button 警鐘系統按鈕	/	/	/	/	/	/	/	/	/	-	/	/	/	/
	Master Bathroom 2 主人浴室 2	Single Socket Outlet 單位電插座	/	/	/	/	/	/	/	/	/	1	/	/	/	/
		Twin Socket Outlet 雙位電插座	/	/	/	/	/	/	/	/	/	1	/	/	/	/
		Lighting Point 燈位	/	/	/	/	/	/	/	/	/	4	/	/	/	/
		Fused Spur Unit 保險絲接線位	/	/	/	/	/	/	/	/	/	2	/	/	/	/
		Fused Spur Unit for Motorized Curtain 電動窗簾保險絲電源接線位	/	/	/	/	/	/	/	/	/	-	/	/	/	/
		Switch For Thermal Ventilator 浴室寶開關	/	/	/	/	/	/	/	/	/	1	/	/	/	/
		TV/ FM Outlet 電視 / 電台天線插座	/	/	/	/	/	/	/	/	/	1	/	/	/	/
		Gas Water Heater Remote Controller 煤氣熱水爐恆溫掣	/	/	/	/	/	/	/	/	/	1	/	/	/	/
	Ensuite 1 套房 1	Twin Socket Outlet 雙位電插座	3	3	3	3	3	4	3	3	3	3	3	3	3	3
		Lighting Switch 燈掣	2	2	2	2	2	5	2	2	3	2	2	2	2	2
		Lighting Point 燈位	1	1	1	1	1	4	1	1	1	1	1	1	1	1
		Switch for AC indoor Unit 空調室內機開關	1	1	1	1	1	1	1	1	1	1	1	1	1	1
		Exhaust Fan Switch 抽氣扇開關	1	1	1	1	1	1	1	1	1	1	1	1	1	1
		Telephone Outlet 電話插座	1	1	1	1	1	2	1	1	1	1	1	1	1	1
		TV/ FM Outlet 電視 / 電台天線插座	1	1	1	1	1	1	1	1	1	1	1	1	1	1
	Flat Roof for Ensuite 1 睡房1平台	Lighting Point 燈位	/	/	/	/	/	/	/	/	/	/	/	/	/	/
	Bathroom 1 浴室1	Twin Socket Outlet 雙位電插座	1	1	1	1	1	-	1	1	1	1	1	1	1	1
		Single Socket Outlet 單位電插座	/	/	/	/	/	1	/	/	/	/	/	/	/	/
		Lighting Point 燈位	3	3	3	3	3	3	3	3	3	3	3	3	3	3
		Fused Spur Unit 保險絲接線位	3	3	3	3	3	1	3	3	3	3	3	3	3	3
		Gas Water Heater Remote Controller 煤氣熱水爐恆溫掣	1	1	1	1	1	1	1	1	1	1	1	1	1	1
	Balcony for Ensuite 1 套房露台1	Lighting Point 燈位	/	/	/	/	/	/	/	/	2	/	/	/	/	

Notes:

- The symbol “ - ” as shown in the above table denotes “Not provided”.
- The symbol “ / ” as shown in the above table denotes “Not applicable”.

備註:

- 上表內之「-」代表「不提供」。
- 上表內之「/」代表「不適用」。

# FITTINGS, FINISHES AND APPLIANCES

## 裝置、裝修物料及設備

### Schedule of Mechanical & Electrical Provisions for Residential Property

#### 住宅單位機電裝置數量說明表

Floor 樓層	Location 位置	Provisions 裝置	House 洋房												
			House 1 1號洋房	House 2 2號洋房	House 3 3號洋房	House 5 5號洋房	House 6 6號洋房	House 7 7號洋房	House 8 8號洋房	House 9 9號洋房	House 10 10號洋房	House 11 11號洋房	House 12 12號洋房		
1/F 1樓	Ensuite 2 套房2	Twin Socket Outlet 雙位電插座	/	/	/	/	/	/	/	/	/	/	3	3	
		Lighting Switch 燈掣	/	/	/	/	/	/	/	/	/	/	/	2	2
		Lighting Point 燈位	/	/	/	/	/	/	/	/	/	/	/	2	1
		Switch for AC indoor Unit 空調室內機開關	/	/	/	/	/	/	/	/	/	/	/	1	1
		Exhaust Fan Switch 抽氣扇開關	/	/	/	/	/	/	/	/	/	/	/	1	1
		Telephone Outlet 電話插座	/	/	/	/	/	/	/	/	/	/	/	1	1
		TV/ FM Outlet 電視 / 電台天線插座	/	/	/	/	/	/	/	/	/	/	/	1	1
	Ensuite 3 套房3	Twin Socket Outlet 雙位電插座	/	/	/	/	/	/	/	/	/	/	/	/	/
		Lighting Switch 燈掣	/	/	/	/	/	/	/	/	/	/	/	/	/
		Lighting Point 燈位	/	/	/	/	/	/	/	/	/	/	/	/	/
		Switch for AC indoor Unit 空調室內機開關	/	/	/	/	/	/	/	/	/	/	/	/	/
		Exhaust Fan Switch 抽氣扇開關	/	/	/	/	/	/	/	/	/	/	/	/	/
		Telephone Outlet 電話插座	/	/	/	/	/	/	/	/	/	/	/	/	/
		TV/ FM Outlet 電視 / 電台天線插座	/	/	/	/	/	/	/	/	/	/	/	/	/
	Bathroom 2 浴室2	Twin Socket Outlet 雙位電插座	/	/	/	/	/	/	/	/	/	/	/	1	1
		Lighting Point 燈位	/	/	/	/	/	/	/	/	/	/	/	3	3
		Fused Spur Unit 保險絲接線位	/	/	/	/	/	/	/	/	/	/	/	3	3
		Gas Water Heater Remote Controller 煤氣熱水爐恆溫掣	/	/	/	/	/	/	/	/	/	/	/	1	1
	Bathroom 3 浴室3	Twin Socket Outlet 雙位電插座	/	/	/	/	/	/	/	/	/	/	/	/	/
		Lighting Point 燈位	/	/	/	/	/	/	/	/	/	/	/	/	/
		Fused Spur Unit 保險絲接線位	/	/	/	/	/	/	/	/	/	/	/	/	/
		Gas Water Heater Remote Controller 煤氣熱水爐恆溫掣	/	/	/	/	/	/	/	/	/	/	/	/	/
	Family Room 家庭室	Lighting Point 燈位	/	/	/	/	/	/	/	/	/	/	/	/	/
		Single Socket Outlet 單位電插座	/	/	/	/	/	/	/	/	/	/	/	/	/
		Switch for AC indoor Unit 空調室內機開關	/	/	/	/	/	/	/	/	/	/	/	/	/
	1/F Lift Lobby 一樓電梯大堂	Single Socket Outlet 單位電插座	1	1	1	1	1	1	1	/	/	/	/	1	1
		Lighting Switch 燈掣	—	—	—	—	—	—	—	/	/	/	/	1	—
		Lighting Point 燈位	1	1	5	1	1	1	/	/	/	/	/	1	1
Fused Spur Unit 保險絲接線位		1	1	—	1	1	1	/	/	/	/	/	—	—	

Notes:

- The symbol “—” as shown in the above table denotes “Not provided”.
- The symbol “/” as shown in the above table denotes “Not applicable”.

備註:

- 上表內之「—」代表「不提供」。
- 上表內之「/」代表「不適用」。



# FITTINGS, FINISHES AND APPLIANCES

## 裝置、裝修物料及設備

### Schedule of Mechanical & Electrical Provisions for Residential Property

#### 住宅單位機電裝置數量說明表

Floor 樓層	Location 位置	Provisions 裝置	House 洋房												
			House 15 15號洋房	House 16 16號洋房	House 17 17號洋房	House 18 18號洋房	House 19 19號洋房	House 20 20號洋房	House 21 21號洋房	House 22 22號洋房	House 23 23號洋房	House 25 25號洋房	House 26 26號洋房	House 27 27號洋房	House 28 28號洋房
1/F 1樓	Ensuite 2 套房2	Twin Socket Outlet 雙位電插座	/	/	/	/	/	/	/	/	/	/	/	/	/
		Lighting Switch 燈掣	/	/	/	/	/	/	/	/	/	/	/	/	/
		Lighting Point 燈位	/	/	/	/	/	/	/	/	/	/	/	/	/
		Switch for AC indoor Unit 空調室內機開關	/	/	/	/	/	/	/	/	/	/	/	/	/
		Exhaust Fan Switch 抽氣扇開關	/	/	/	/	/	/	/	/	/	/	/	/	/
		Telephone Outlet 電話插座	/	/	/	/	/	/	/	/	/	/	/	/	/
		TV/ FM Outlet 電視 / 電台天線插座	/	/	/	/	/	/	/	/	/	/	/	/	/
	Ensuite 3 套房3	Twin Socket Outlet 雙位電插座	/	/	/	/	/	/	/	/	/	3	/	/	/
		Lighting Switch 燈掣	/	/	/	/	/	/	/	/	/	2	/	/	/
		Lighting Point 燈位	/	/	/	/	/	/	/	/	/	1	/	/	/
		Switch for AC indoor Unit 空調室內機開關	/	/	/	/	/	/	/	/	/	1	/	/	/
		Exhaust Fan Switch 抽氣扇開關	/	/	/	/	/	/	/	/	/	1	/	/	/
		Telephone Outlet 電話插座	/	/	/	/	/	/	/	/	/	1	/	/	/
		TV/ FM Outlet 電視 / 電台天線插座	/	/	/	/	/	/	/	/	/	1	/	/	/
	Bathroom 2 浴室2	Twin Socket Outlet 雙位電插座	/	/	/	/	/	/	/	/	/	/	/	/	/
		Lighting Point 燈位	/	/	/	/	/	/	/	/	/	/	/	/	/
		Fused Spur Unit 保險絲接線位	/	/	/	/	/	/	/	/	/	/	/	/	/
		Gas Water Heater Remote Controller 煤氣熱水爐恆溫掣	/	/	/	/	/	/	/	/	/	/	/	/	/
	Bathroom 3 浴室3	Twin Socket Outlet 雙位電插座	/	/	/	/	/	/	/	/	/	1	/	/	/
		Lighting Point 燈位	/	/	/	/	/	/	/	/	/	3	/	/	/
		Fused Spur Unit 保險絲接線位	/	/	/	/	/	/	/	/	/	2	/	/	/
		Gas Water Heater Remote Controller 煤氣熱水爐恆溫掣	/	/	/	/	/	/	/	/	/	1	/	/	/
	Family Room 家庭室	Lighting Point 燈位	/	/	/	/	/	/	/	/	/	1	/	/	/
		Single Socket Outlet 單位電插座	/	/	/	/	/	/	/	/	/	2	/	/	/
		Switch for AC indoor Unit 空調室內機開關	/	/	/	/	/	/	/	/	/	1	/	/	/
	1/F Lift Lobby 一樓電梯大堂	Single Socket Outlet 單位電插座	1	1	1	1	1	—	1	1	/	1	1	1	1
		Lighting Switch 燈掣	—	—	—	—	—	—	—	—	/	—	—	—	—
		Lighting Point 燈位	1	1	1	1	1	3	1	1	/	1	1	1	1
Fused Spur Unit 保險絲接線位		—	—	—	—	—	—	—	—	/	1	1	1	1	

Notes:

- The symbol “—” as shown in the above table denotes “Not provided”.
- The symbol “/” as shown in the above table denotes “Not applicable”.

備註:

- 上表內之「—」代表「不提供」。
- 上表內之「/」代表「不適用」。

# FITTINGS, FINISHES AND APPLIANCES

## 裝置、裝修物料及設備

### Schedule of Mechanical & Electrical Provisions for Residential Property

#### 住宅單位機電裝置數量說明表

Floor 樓層	Location 位置	Provisions 裝置	House 洋房											
			House 1 1號洋房	House 2 2號洋房	House 3 3號洋房	House 5 5號洋房	House 6 6號洋房	House 7 7號洋房	House 8 8號洋房	House 9 9號洋房	House 10 10號洋房	House 11 11號洋房	House 12 12號洋房	
2/F 2樓	Master Bedroom 2 主人睡房2  (Master Bedroom for House 20 only) (只供20號洋房主人睡房)	Twin Socket Outlet 雙位電插座	3	3	3	3	3	3	3	3	3	3	3	
		Lighting Switch 燈掣	3	3	6	3	3	3	3	3	3	3	3	3
		Lighting Point 燈位	2	2	7	2	2	2	2	2	2	2	3	3
		Switch for AC indoor Unit 空調室內機開關	1	1	1	1	1	1	1	1	1	1	2	2
		Fused Spur Unit for Motorized Curtain 電動窗簾保險絲電源接線位	1	1	1	1	1	1	1	1	1	1	1	3
		Telephone Outlet 電話插座	2	2	1	2	2	2	2	2	2	2	2	2
		TV/ FM Outlet 電視 / 電台天線插座	2	2	1	2	2	2	2	2	2	2	2	2
		Panic Alarm Button 警鐘系統按鈕	1	1	1	1	1	1	1	1	1	1	1	1
		Single Socket Outlet 單位電插座	—	—	—	—	—	—	—	—	—	—	—	—
		Power Point for LED 燈位	—	—	—	—	—	—	—	—	—	—	—	—
	Master Bedroom 3 主人睡房3	Twin Socket Outlet 雙位電插座	/	/	/	/	/	/	/	/	/	/	/	
		Lighting Switch 燈掣	/	/	/	/	/	/	/	/	/	/	/	
		Lighting Point 燈位	/	/	/	/	/	/	/	/	/	/	/	
		Switch for AC indoor Unit 空調室內機開關	/	/	/	/	/	/	/	/	/	/	/	
		Fused Spur Unit for Motorized Curtain 電動窗簾保險絲電源接線位	/	/	/	/	/	/	/	/	/	/	/	
		Telephone Outlet 電話插座	/	/	/	/	/	/	/	/	/	/	/	
		TV/ FM Outlet 電視 / 電台天線插座	/	/	/	/	/	/	/	/	/	/	/	
		Panic Alarm Button 警鐘系統按鈕	/	/	/	/	/	/	/	/	/	/	/	
	Flat Roof for Master Bedroom 2 主人睡房2平台	Lighting Point 燈位	/	/	/	/	/	/	/	/	/	4	/	
	Flat Roof for Master Bedroom 3 主人睡房3平台	Lighting Point 燈位	/	/	/	/	/	/	/	/	/	/	/	

Notes:

1. The symbol “—” as shown in the above table denotes “Not provided”.
2. The symbol “/” as shown in the above table denotes “Not applicable”.

備註:

1. 上表內之「—」代表「不提供」。
2. 上表內之「/」代表「不適用」。

# FITTINGS, FINISHES AND APPLIANCES

## 裝置、裝修物料及設備

### Schedule of Mechanical & Electrical Provisions for Residential Property

#### 住宅單位機電裝置數量說明表

Floor 樓層	Location 位置	Provisions 裝置	House 洋房												
			House 15 15號洋房	House 16 16號洋房	House 17 17號洋房	House 18 18號洋房	House 19 19號洋房	House 20 20號洋房	House 21 21號洋房	House 22 22號洋房	House 23 23號洋房	House 25 25號洋房	House 26 26號洋房	House 27 27號洋房	House 28 28號洋房
2/F 2樓	Master Bedroom 2 主人睡房2  (Master Bedroom for House 20 only) (只供20號洋房主 人睡房)	Twin Socket Outlet 雙位電插座	3	3	3	3	3	6	3	3	/	3	3	3	3
		Lighting Switch 燈掣	3	3	3	3	3	6	3	3	/	3	3	3	3
		Lighting Point 燈位	4	4	4	4	4	8	4	4	/	2	2	2	2
		Switch for AC indoor Unit 空調室內機開關	1	1	1	1	1	1	1	1	/	1	1	1	1
		Fused Spur Unit for Motorized Curtain 電動窗簾保險絲電源接線位	1	1	1	1	1	1	1	1	/	1	1	1	1
		Telephone Outlet 電話插座	2	2	2	2	2	1	2	2	/	2	2	2	2
		TV/ FM Outlet 電視 / 電台天線插座	2	2	2	2	2	1	2	2	/	2	2	2	2
		Panic Alarm Button 警鐘系統按鈕	1	1	1	1	1	1	1	1	/	1	1	1	1
		Single Socket Outlet 單位電插座	—	—	—	—	—	1	—	—	/	—	—	—	—
		Power Point for LED LED 燈位	—	—	—	—	—	1	—	—	/	—	—	—	—
	Master Bedroom 3 主人睡房3	Twin Socket Outlet 雙位電插座	/	/	/	/	/	/	/	/	3	/	/	/	/
		Lighting Switch 燈掣	/	/	/	/	/	/	/	/	4	/	/	/	/
		Lighting Point 燈位	/	/	/	/	/	/	/	/	4	/	/	/	/
		Switch for AC indoor Unit 空調室內機開關	/	/	/	/	/	/	/	/	2	/	/	/	/
		Fused Spur Unit for Motorized Curtain 電動窗簾保險絲電源接線位	/	/	/	/	/	/	/	/	3	/	/	/	/
		Telephone Outlet 電話插座	/	/	/	/	/	/	/	/	2	/	/	/	/
		TV/ FM Outlet 電視 / 電台天線插座	/	/	/	/	/	/	/	/	2	/	/	/	/
		Panic Alarm Button 警鐘系統按鈕	/	/	/	/	/	/	/	/	—	/	/	/	/
	Flat Roof for Master Bedroom 2 主人睡房2平台	Lighting Point 燈位	/	/	/	/	/	/	/	/	/	/	/	/	/
	Flat Roof for Master Bedroom 3 主人睡房3平台	Lighting Point 燈位	/	/	/	/	/	/	/	/	7	/	/	/	/

Notes:

- The symbol “—” as shown in the above table denotes “Not provided”.
- The symbol “/” as shown in the above table denotes “Not applicable”.

備註:

- 上表內之「—」代表「不提供」。
- 上表內之「/」代表「不適用」。

FITTINGS, FINISHES AND APPLIANCES

裝置、裝修物料及設備

Schedule of Mechanical & Electrical Provisions for Residential Property

住宅單位機電裝置數量說明表

Floor 樓層	Location 位置	Provisions 裝置	House 洋房											
			House 1 1號洋房	House 2 2號洋房	House 3 3號洋房	House 5 5號洋房	House 6 6號洋房	House 7 7號洋房	House 8 8號洋房	House 9 9號洋房	House 10 10號洋房	House 11 11號洋房	House 12 12號洋房	
2/F 2樓	Master Bathroom 2 主人浴室2  (Master Bathroom for House 20 only 只供20號洋房主人浴室)	Single Socket Outlet 單位電插座	1	1	2	1	1	1	1	1	1	1	1	1
		Twin Socket Outlet 雙位電插座	1	1	—	1	1	1	1	1	1	1	1	1
		Lighting Point 燈位	5	5	6	5	5	5	6	6	6	6	5	5
		Fused Spur Unit 保險絲接線位	2	2	2	2	2	2	2	2	2	2	3	3
		Fused Spur Unit for Motorized Curtain 電動窗簾保險絲電源接線位	—	—	—	—	—	—	1	1	1	1	2	1
		Switch For Thermal Ventilator 浴室寶開關	1	1	—	1	1	1	1	1	1	1	1	1
		TV/ FM Outlet 電視 / 電台天線插座	1	1	1	1	1	1	1	1	1	1	1	2
		Gas Water Heater Remote Controller 煤氣熱水爐恆溫掣	1	1	1	1	1	1	1	1	1	1	1	1
	Balcony for Master Bedroom 2 主人睡房露台  (Balcony for Master Bedroom for House 20 only 只供20號洋房主人睡房露台)	Lighting Point 燈位	1	1	1	1	1	1	1	1	1	1	1	
	Master Bathroom 3 主人浴室3	Single Socket Outlet 單位電插座	/	/	/	/	/	/	/	/	/	/	/	/
		Twin Socket Outlet 雙位電插座	/	/	/	/	/	/	/	/	/	/	/	/
		Lighting Point 燈位	/	/	/	/	/	/	/	/	/	/	/	/
		Fused Spur Unit 保險絲接線位	/	/	/	/	/	/	/	/	/	/	/	/
		Fused Spur Unit for Motorized Curtain 電動窗簾保險絲電源接線位	/	/	/	/	/	/	/	/	/	/	/	/
		Switch For Thermal Ventilator 浴室寶開關	/	/	/	/	/	/	/	/	/	/	/	/
		TV/ FM Outlet 電視 / 電台天線插座	/	/	/	/	/	/	/	/	/	/	/	/
		Gas Water Heater Remote Controller 煤氣熱水爐恆溫掣	/	/	/	/	/	/	/	/	/	/	/	/
	Ensuite 2 睡房 2	Twin Socket Outlet 雙位電插座	3	3	3	3	3	3	3	3	3	3	3	3
		Lighting Switch 燈掣	2	2	2	2	2	2	2	2	2	2	2	2
		Lighting Point 燈位	1	1	4	1	1	1	2	2	2	2	2	2
		Switch for AC indoor Unit 空調室內機開關	1	1	1	1	1	1	1	1	1	1	1	1
Exhaust Fan Switch 抽氣扇開關		1	1	1	1	1	1	1	1	1	1	1	1	
Telephone Outlet 電話插座		1	1	—	1	1	1	1	1	1	1	1	1	
TV/ FM Outlet 電視 / 電台天線插座		1	1	—	1	1	1	1	1	1	1	1	1	

Notes:

1. The symbol “—” as shown in the above table denotes “Not provided”.
2. The symbol “/” as shown in the above table denotes “Not applicable”.

備註:

1. 上表內之「—」代表「不提供」。
2. 上表內之「/」代表「不適用」。

# FITTINGS, FINISHES AND APPLIANCES

## 裝置、裝修物料及設備

### Schedule of Mechanical & Electrical Provisions for Residential Property

#### 住宅單位機電裝置數量說明表

Floor 樓層	Location 位置	Provisions 裝置	House 洋房													
			House 15 15號洋房	House 16 16號洋房	House 17 17號洋房	House 18 18號洋房	House 19 19號洋房	House 20 20號洋房	House 21 21號洋房	House 22 22號洋房	House 23 23號洋房	House 25 25號洋房	House 26 26號洋房	House 27 27號洋房	House 28 28號洋房	
2/F 2樓	Master Bathroom 2 主人浴室2  (Master Bathroom for House 20 only 只供20號洋房主人浴室)	Single Socket Outlet 單位電插座	1	1	1	1	1	1	1	1	1	/	1	1	1	1
		Twin Socket Outlet 雙位電插座	1	1	1	1	1	—	1	1	/	1	1	1	1	
		Lighting Point 燈位	6	6	6	6	6	5	6	6	/	5	5	5	5	
		Fused Spur Unit 保險絲接線位	2	2	2	2	2	—	2	2	/	2	2	2	2	
		Fused Spur Unit for Motorized Curtain 電動窗簾保險絲電源接線位	—	—	—	—	—	—	—	—	/	—	—	—	—	
		Switch For Thermal Ventilator 浴室寶開關	1	1	1	1	1	1	1	1	/	1	1	1	1	
		TV/ FM Outlet 電視 / 電台天線插座	1	1	1	1	1	—	1	1	/	1	1	1	1	
		Gas Water Heater Remote Controller 煤氣熱水爐恆溫掣	1	1	1	1	1	1	1	1	/	1	1	1	1	
	Balcony for Master Bedroom 2 主人睡房露台  (Master Bedroom for House 20 only 只供20號洋房主人睡房)	Lighting Point 燈位	1	1	1	1	1	1	1	1	1	/	1	1	1	1
	Master Bathroom 3 主人浴室3	Single Socket Outlet 單位電插座	/	/	/	/	/	/	/	/	/	1	/	/	/	/
		Twin Socket Outlet 雙位電插座	/	/	/	/	/	/	/	/	/	1	/	/	/	/
		Lighting Point 燈位	/	/	/	/	/	/	/	/	/	11	/	/	/	/
		Fused Spur Unit 保險絲接線位	/	/	/	/	/	/	/	/	/	3	/	/	/	/
		Fused Spur Unit for Motorized Curtain 電動窗簾保險絲電源接線位	/	/	/	/	/	/	/	/	/	1	/	/	/	/
		Switch For Thermal Ventilator 浴室寶開關	/	/	/	/	/	/	/	/	/	2	/	/	/	/
		TV/ FM Outlet 電視 / 電台天線插座	/	/	/	/	/	/	/	/	/	1	/	/	/	/
		Gas Water Heater Remote Controller 煤氣熱水爐恆溫掣	/	/	/	/	/	/	/	/	/	1	/	/	/	/
	Ensuite 2 睡房 2	Twin Socket Outlet 雙位電插座	3	3	3	3	3	4	3	3	3	3	3	3	3	3
		Lighting Switch 燈掣	2	2	2	2	2	5	2	2	3	2	2	2	2	
		Lighting Point 燈位	1	1	1	1	1	4	1	1	2	1	1	1	1	
		Switch for AC indoor Unit 空調室內機開關	1	1	1	1	1	1	1	1	1	1	1	1	1	
		Exhaust Fan Switch 抽氣扇開關	1	1	1	1	1	1	1	1	1	1	1	1	1	
		Telephone Outlet 電話插座	1	1	1	1	1	2	1	1	2	1	1	1	1	
		TV/ FM Outlet 電視 / 電台天線插座	1	1	1	1	1	1	1	1	2	1	1	1	1	

Notes:

- The symbol “—” as shown in the above table denotes “Not provided”.
- The symbol “/” as shown in the above table denotes “Not applicable”.

備註:

- 上表內之「—」代表「不提供」。
- 上表內之「/」代表「不適用」。



FITTINGS, FINISHES AND APPLIANCES

裝置、裝修物料及設備

Schedule of Mechanical & Electrical Provisions for Residential Property

住宅單位機電裝置數量說明表

Floor 樓層	Location 位置	Provisions 裝置	House 洋房												
			House 1 1號洋房	House 2 2號洋房	House 3 3號洋房	House 5 5號洋房	House 6 6號洋房	House 7 7號洋房	House 8 8號洋房	House 9 9號洋房	House 10 10號洋房	House 11 11號洋房	House 12 12號洋房		
2/F 2樓	Ensuite 3 套房3	Twin Socket Outlet 雙位電插座	/	/	/	/	/	/	/	/	/	/	3	3	
		Lighting Switch 燈掣	/	/	/	/	/	/	/	/	/	/	/	2	2
		Lighting Point 燈位	/	/	/	/	/	/	/	/	/	/	/	2	2
		Switch for AC indoor Unit 空調室內機開關	/	/	/	/	/	/	/	/	/	/	/	1	1
		Exhaust Fan Switch 抽氣扇開關	/	/	/	/	/	/	/	/	/	/	/	1	1
		Telephone Outlet 電話插座	/	/	/	/	/	/	/	/	/	/	/	1	1
		TV/ FM Outlet 電視 / 電台天線插座	/	/	/	/	/	/	/	/	/	/	/	1	1
	Flat Roof for Ensuite 2 套房2平台	Lighting Point 燈位	/	/	/	/	/	/	/	/	/	/	/	/	/
	Bathroom 2 浴室2	Single Socket Outlet 單位電插座	/	/	2	/	/	/	/	/	/	/	/	/	/
		Twin Socket Outlet 雙位電插座	1	1	—	1	1	1	1	1	1	1	/	/	
		Lighting Point 燈位	3	3	1	3	3	3	3	3	3	3	/	/	
		Fused Spur Unit 保險絲接線位	3	3	2	3	3	3	3	3	3	3	/	/	
		Gas Water Heater Remote Controller 煤氣熱水爐恆溫掣	1	1	1	1	1	1	1	1	1	1	/	/	
	Bathroom 3 浴室3	Twin Socket Outlet 雙位電插座	/	/	/	/	/	/	/	/	/	/	/	1	1
		Lighting Point 燈位	/	/	/	/	/	/	/	/	/	/	/	3	3
		Fused Spur Unit 保險絲接線位	/	/	/	/	/	/	/	/	/	/	/	3	3
		Gas Water Heater Remote Controller 煤氣熱水爐恆溫掣	/	/	/	/	/	/	/	/	/	/	/	1	1
	2/F Lift Lobby 2樓電梯大堂	Single Socket Outlet 單位電插座	1	1	1	1	1	1	1	/	/	/	/	1	1
		Lighting Switch 燈掣	—	—	—	—	—	—	—	/	/	/	/	1	—
		Lighting Point 燈位	1	1	5	1	1	1	/	/	/	/	/	1	1
Fused Spur Unit 保險絲接線位		1	1	—	1	1	1	/	/	/	/	/	—	—	
Switch For Lift 電梯開關		2	2	2	2	2	2	2	/	/	/	/	2	2	
R/F 天台	Internal Staircase and Landing 室內樓梯通道	Single Socket Outlet 單位電插座	/	/	/	/	/	/	/	/	/	/	/	/	
		Lighting Switch 燈掣	7	7	7	7	7	7	7	7	6	7	5	7	
		Lighting Point 燈位	10	10	22	10	10	10	11	11	11	11	10	9	
		Door Bell 門鐘	—	—	—	—	—	—	—	—	—	—	—	—	
		Switch for AC indoor Unit 空調室內機開關	1	1	1	1	1	1	1	1	1	1	1	1	
	Roof 天台	Lighting Point 燈位	7	7	5	7	7	7	7	3	4	3	6	8	
		Single Waterproof Socket Outlet 防水單位電插座	1	1	1	1	1	1	1	1	1	1	1	1	
		Fused Spur Unit for Gas Water Heater 煤氣熱水爐保險絲電源接線位	2	2	2	2	2	2	2	2	2	2	3	3	
	A/C Plant 冷氣機櫃	Switch for AC Outdoor Unit 空調室外機開關	2	2	2	2	2	2	2	2	2	2	2	2	

Notes:

1. The symbol “ — ” as shown in the above table denotes “Not provided”.
2. The symbol “ / ” as shown in the above table denotes “Not applicable”.

備註:

1. 上表內之「—」代表「不提供」。
2. 上表內之「/」代表「不適用」。

FITTINGS, FINISHES AND APPLIANCES

裝置、裝修物料及設備

Schedule of Mechanical & Electrical Provisions for Residential Property

住宅單位機電裝置數量說明表

Floor 樓層	Location 位置	Provisions 裝置	House 洋房													
			House 15 15號洋房	House 16 16號洋房	House 17 17號洋房	House 18 18號洋房	House 19 19號洋房	House 20 20號洋房	House 21 21號洋房	House 22 22號洋房	House 23 23號洋房	House 25 25號洋房	House 26 26號洋房	House 27 27號洋房	House 28 28號洋房	
2/F 2樓	Ensuite 3 套房 3	Twin Socket Outlet 雙位電插座	/	/	/	/	/	/	/	/	/	/	/	/	/	/
		Lighting Switch 燈掣	/	/	/	/	/	/	/	/	/	/	/	/	/	/
		Lighting Point 燈位	/	/	/	/	/	/	/	/	/	/	/	/	/	/
		Switch for AC indoor Unit 空調室內機開關	/	/	/	/	/	/	/	/	/	/	/	/	/	/
		Exhaust Fan Switch 抽氣扇開關	/	/	/	/	/	/	/	/	/	/	/	/	/	/
		Telephone Outlet 電話插座	/	/	/	/	/	/	/	/	/	/	/	/	/	/
		TV/ FM Outlet 電視 / 電台天線插座	/	/	/	/	/	/	/	/	/	/	/	/	/	/
	Flat Roof for Ensuite 2 套房2平台	Lighting Point 燈位	/	/	/	/	/	/	/	/	2	/	/	/	/	/
	Bathroom 2 浴室2	Single Socket Outlet 單位電插座	/	/	/	/	/	1	/	/	/	/	/	/	/	/
		Twin Socket Outlet 雙位電插座	1	1	1	1	1	—	1	1	1	1	1	1	1	1
		Lighting Point 燈位	3	3	3	3	3	3	3	3	3	3	3	3	3	3
		Fused Spur Unit 保險絲接線位	3	3	3	3	3	2	3	3	3	3	3	3	3	3
		Gas Water Heater Remote Controller 煤氣熱水爐恆溫掣	1	1	1	1	1	1	1	1	1	1	1	1	1	1
	Bathroom 3 浴室3	Twin Socket Outlet 雙位電插座	/	/	/	/	/	/	/	/	/	/	/	/	/	/
		Lighting Point 燈位	/	/	/	/	/	/	/	/	/	/	/	/	/	/
		Fused Spur Unit 保險絲接線位	/	/	/	/	/	/	/	/	/	/	/	/	/	/
		Gas Water Heater Remote Controller 煤氣熱水爐恆溫掣	/	/	/	/	/	/	/	/	/	/	/	/	/	/
	2/F Lift Lobby 2樓電梯大堂	Single Socket Outlet 單位電插座	1	1	1	1	1	—	1	1	1	1	1	1	1	1
		Lighting Switch 燈掣	—	—	—	—	—	—	—	—	—	—	—	—	—	—
		Lighting Point 燈位	1	1	1	1	1	3	1	1	1	1	1	1	1	1
Fused Spur Unit 保險絲接線位		—	—	—	—	—	—	—	—	—	1	1	1	1	1	
Switch For Lift 電梯開關		2	2	2	2	2	2	2	2	2	2	2	2	2	2	
R/F 天台	Internal Staircase and Landing 室內樓梯通道	Single Socket Outlet 單位電插座	/	/	/	/	/	1	/	/	/	/	/	/	/	
		Lighting Switch 燈掣	7	7	7	7	7	13	7	7	7	6	6	6	6	
		Lighting Point 燈位	10	10	10	10	10	4	10	10	10	6	7	6	6	
		Door Bell 門鐘	—	—	—	—	—	—	—	—	—	—	—	—	—	—
		Switch for AC indoor Unit 空調室內機開關	1	1	1	1	1	1	1	1	1	1	1	1	1	1
	Roof 天台	Lighting Point 燈位	8	8	8	8	8	7	8	8	9	6	6	6	6	
		Single Waterproof Socket Outlet 防水單位電插座	2	2	2	2	2	2	2	2	1	1	1	1	1	
		Fused Spur Unit for Gas Water Heater 煤氣熱水爐保險絲電源接線位	2	2	2	2	2	2	2	2	3	2	2	2	2	
	A/C Plant. 冷氣機櫃	Switch for AC Outdoor Unit 空調室外機開關	2	2	2	2	2	2	2	2	2	2	2	2	2	

Notes:

- The symbol “ — ” as shown in the above table denotes “Not provided”.
- The symbol “ / ” as shown in the above table denotes “Not applicable”.

備註:

- 上表內之「—」代表「不提供」。
- 上表內之「/」代表「不適用」。

# FITTINGS, FINISHES AND APPLIANCES

## 裝置、裝修物料及設備

### Schedule of Mechanical & Electrical Provisions for Residential Property

#### 住宅單位機電裝置數量說明表

Location 位置	Provisions 裝置	Tower 1 第1座					
		G/F - 1/F 地下至1樓	1/F 1樓	2/F 2樓		3/F, 5/F - 10/F 3樓、5樓至 10樓	11/F 11樓
		Garden Duplex	• Terrace Apartment	Flat A A單位	Flat B B單位	Flat A & B A及B單位	Sky Pool Penthouse
Private Lift Lobby 私人電梯大堂	Lighting Point 燈位		5	5	5	5	5
	Door Bell Push Button 門鈴按鈕		1	1	1	1	1
	Fused Spur Unit 保險絲接線位		1	1	1	1	1
Living Room & Dining Room 客廳及飯廳	Single Socket Outlet 單位電插座	3	1	1	1	1	3
	Twin Socket Outlet 雙位電插座	5	3	3	3	3	6
	Telephone Outlet 電話插座	2	2	2	2	2	2
	TV/ FM Outlet 電視 / 電台天線插座	2	2	2	2	2	2
	Window Contact 窗磁控感應器	1	—	—	—	—	—
	Door Contact 門磁控感應器	5	—	—	—	—	—
	Breakglass Sensor 玻璃碎裂感應器	4	—	—	—	—	—
	Lighting Point 燈位	13	4	4	4	4	11
	Lighting Switch 燈掣	9	7	7	7	7	9
	Fused Spur Unit for Motorized Curtain 電動窗簾保險絲接線位	1	1	1	1	1	1
	Fused Spur Unit 保險絲接線位	2	—	—	—	—	1
	Switch for AC indoor Unit 空調室內機開關	3	2	2	2	2	4
	Switch for Steamer 蒸爐開關掣	1	—	—	—	—	1
	Switch for Oven 焗爐開關制	1	—	—	—	—	1
	Switch for Exhaust Fan 抽氣扇開關掣	2	2	2	2	2	2
	Security System Control Keypad 保安系統鍵盤控制面板	1	—	—	—	—	—
	Video Door Phone 視像對講機	1	1	—	—	—	1
	Door phone 門口對講機	—	—	1	1	1	—
Water Inlet / Outlet Connection Point for Washing Machine 洗衣機來 / 去水位接駁點	1	—	—	—	—	—	
Hallway 走廊/門廳	Single Socket Outlet 單位電插座	1					
	Twin Socket Outlet 雙位電插座	1					
	Telephone Outlet 電話插座	1					
	TV/ FM Outlet 電視 / 電台天線插座	1					
	Lighting Point 燈位	4					

#### Notes:

- The symbol “ — ” as shown in the above table denotes “Not provided”.
- The symbol “ / ” as shown in the above table denotes “Not applicable”.
- “Terrace Apartment”, “Garden Apartment” and “Courtyard Penthouse” are names for marketing purposes only and will not appear in any Deed of Mutual Covenant, the Preliminary Agreement for Sale and Purchase, Agreement for Sale and Purchase, Assignment, or any other title deeds and documents relating to the Development. The names as appearing on the approved building plans are: Flat A on 1/F of Tower 1 for Terrace Apartment on 1/F of Tower 1; Flat B on G/F of Tower 2 for Garden Apartment on G/F of Tower 2; Flat B on G/F of Tower 3 for Garden Apartment on G/F of Tower 3; Flat A on G/F of Tower 7 for Garden Apartment on G/F of Tower 7; Penthouse on 11/F of Tower 7 for Courtyard Penthouse on 11/F of Tower 7; Flat B on G/F of Tower 8 for Garden Apartment on G/F of Tower 8; Penthouse on 11/F of Tower 8 for Courtyard Penthouse on 11/F of Tower 8.

#### 備註:

- 上表內之「—」代表「不提供」。
- 上表內之「/」代表「不適用」。
- 「Terrace Apartment」、「Garden Apartment」及「Courtyard Penthouse」僅為市場推廣之用的名稱，並不會於關於發展項目的任何公契、臨時買賣合約、買賣合約、轉讓契及契據出現。經批准的建築圖則上顯示的名稱為：第1座1樓A單位（即第1座1樓Terrace Apartment）；第2座地下B單位（即第2座地下Garden Apartment）；第3座地下B單位（即第3座地下Garden Apartment）；第7座地下A單位（即第7座地下Garden Apartment）；第7座11樓Penthouse（即第7座11樓Courtyard Penthouse）；第8座地下B單位（即第8座地下Garden Apartment）；第8座11樓Penthouse（即第8座11樓Courtyard Penthouse）。

# FITTINGS, FINISHES AND APPLIANCES

## 裝置、裝修物料及設備

### Schedule of Mechanical & Electrical Provisions for Residential Property

#### 住宅單位機電裝置數量說明表

Location 位置	Provisions 裝置	Tower 1 第1座					
		G/F - 1/F 地下至1樓	1/F 1樓	2/F 2樓		3/F, 5/F - 10/F 3樓、5樓至 10樓	11/F 11樓
		Garden Duplex	• Terrace Apartment	Flat A A單位	Flat B B單位	Flat A & B A及B單位	Sky Pool Penthouse
Hallway 走廊/門廳	Lighting Switch 燈掣	3					
	Switch for AC indoor Unit 空調室內機開關	1					
Staircase 樓梯	Lighting Point 燈位	1					1
Entrance Lobby 電梯大堂	Door Bell Push Button 門鈴按鈕	1					
Master Bedroom 主人睡房	Twin Socket Outlet 雙位電插座	3	2	2	2	2	2
	Telephone Outlet 電話插座	2	2	2	2	2	2
	TV/ FM Outlet 電視 / 電台天線插座	2	2	2	2	2	2
	Panic Alarm Button 警鐘按鈕	1	1	1	1	1	1
	Lighting Point 燈位	3	1	1	1	1	2
	Lighting Switch 燈掣	4	2	2	2	2	2
	Fused Spur Unit for Motorized Curtain 電動窗簾保險絲接線位	1	1	1	1	1	1
	Switch for AC indoor Unit 空調室內機開關	2	1	1	1	1	2
	Door Contact 門磁控感應器	—	—	—	—	—	—
	Window Contact 窗磁控感應器	—	—	—	—	—	—
Ensuite 1 套房 1	Twin Socket Outlet 雙位電插座	2	2	2	2	2	2
	Telephone Outlet 電話插座	1	1	1	1	1	1
	TV/ FM Outlet 電視 / 電台天線插座	1	1	1	1	1	1
	Lighting Point 燈位	1	1	1	1	1	1
	Lighting Switch 燈掣	2	3	3	3	3	2
	Switch for AC indoor Unit 空調室內機開關	1	1	1	1	1	1
	Switch for Exhaust Fan 抽氣扇開關掣	1	1	1	1	1	1
	Door Contact 門磁控感應器	—	—	—	—	—	—
	Window Contact 窗磁控感應器	—	—	—	—	—	—
	Breakglass Sensor 玻璃碎裂感應器	—	—	—	—	—	—

#### Notes:

- The symbol “—” as shown in the above table denotes “Not provided”.
- The symbol “/” as shown in the above table denotes “Not applicable”.
- “Terrace Apartment”, “Garden Apartment” and “Courtyard Penthouse” are names for marketing purposes only and will not appear in any Deed of Mutual Covenant, the Preliminary Agreement for Sale and Purchase, Agreement for Sale and Purchase, Assignment, or any other title deeds and documents relating to the Development. The names as appearing on the approved building plans are: Flat A on 1/F of Tower 1 for Terrace Apartment on 1/F of Tower 1; Flat B on G/F of Tower 2 for Garden Apartment on G/F of Tower 2; Flat B on G/F of Tower 3 for Garden Apartment on G/F of Tower 3; Flat A on G/F of Tower 7 for Garden Apartment on G/F of Tower 7; Penthouse on 11/F of Tower 7 for Courtyard Penthouse on 11/F of Tower 7; Flat B on G/F of Tower 8 for Garden Apartment on G/F of Tower 8; Penthouse on 11/F of Tower 8 for Courtyard Penthouse on 11/F of Tower 8.

#### 備註:

- 上表內之「—」代表「不提供」。
- 上表內之「/」代表「不適用」。
- 「Terrace Apartment」、「Garden Apartment」及「Courtyard Penthouse」僅為市場推廣之用的名稱，並不會於關於發展項目的任何公契、臨時買賣合約、買賣合約、轉讓契及契據出現。經批准的建築圖則上顯示的名稱為：第1座1樓A單位（即第1座1樓Terrace Apartment）；第2座地下B單位（即第2座地下Garden Apartment）；第3座地下B單位（即第3座地下Garden Apartment）；第7座地下A單位（即第7座地下Garden Apartment）；第7座11樓Penthouse（即第7座11樓Courtyard Penthouse）；第8座地下B單位（即第8座地下Garden Apartment）；第8座11樓Penthouse（即第8座11樓Courtyard Penthouse）。



# FITTINGS, FINISHES AND APPLIANCES

## 裝置、裝修物料及設備

### Schedule of Mechanical & Electrical Provisions for Residential Property

#### 住宅單位機電裝置數量說明表

Location 位置	Provisions 裝置	Tower 1 第1座					
		G/F - 1/F 地下至1樓	1/F 1樓	2/F 2樓		3/F, 5/F - 10/F 3樓、5樓至 10樓	11/F 11樓
		Garden Duplex	• Terrace Apartment	Flat A A單位	Flat B B單位	Flat A & B A及B單位	Sky Pool Penthouse
Ensuite 2 套房 2	Twin Socket Outlet 雙位電插座	2	2	2	2	2	2
	Telephone Outlet 電話插座	1	1	1	1	1	1
	TV/ FM Outlet 電視 / 電台天線插座	1	1	1	1	1	1
	Lighting Point 燈位	1	1	1	1	1	1
	Lighting Switch 燈掣	2	2	2	2	2	2
	Switch for AC indoor Unit 空調室內機開關	1	1	1	1	1	1
	Switch for Exhaust Fan 抽氣扇開關掣	1	1	1	1	1	1
	Door Contact 門磁控感應器	—	—	—	—	—	—
	Window Contact 窗磁控感應器	—	—	—	—	—	—
	Breakglass Sensor 玻璃碎裂感應器	—	—	—	—	—	—
Ensuite 3 套房 3	Twin Socket Outlet 雙位電插座	2	2	2	2	2	2
	Telephone Outlet 電話插座	1	1	1	1	1	1
	TV/ FM Outlet 電視 / 電台天線插座	1	1	1	1	1	1
	Lighting Point 燈位	1	1	1	1	1	1
	Lighting Switch 燈掣	2	2	2	2	2	3
	Switch for AC indoor Unit 空調室內機開關	1	1	1	1	1	1
	Switch for Exhaust Fan 抽氣扇開關掣	1	1	1	1	1	1
	Door Contact 門磁控感應器	—	—	—	—	—	—
Kitchen 廚房	Single Socket Outlet 單位電插座	2	5	5	5	5	2
	Twin Socket Outlet 雙位電插座	2	4	4	4	4	3
	Lighting Point 燈位	4	10	10	10	10	4
	Switch for Steamer 蒸爐開關制	—	—	—	—	—	—
	Switch for Oven 焗爐開關制	—	1	1	1	1	—
	Switch for Induction Cooker 電磁爐開關制	1	1	1	1	1	1
	Fused Spur Unit 保險絲接線位	4	6	6	6	6	6
	Switch for AC indoor Unit 空調室內機開關	1	1	1	1	1	1

#### Notes:

- The symbol “ — ” as shown in the above table denotes “Not provided”.
- The symbol “ / ” as shown in the above table denotes “Not applicable”.
- “Terrace Apartment”, “Garden Apartment” and “Courtyard Penthouse” are names for marketing purposes only and will not appear in any Deed of Mutual Covenant, the Preliminary Agreement for Sale and Purchase, Agreement for Sale and Purchase, Assignment, or any other title deeds and documents relating to the Development. The names as appearing on the approved building plans are: Flat A on 1/F of Tower 1 for Terrace Apartment on 1/F of Tower 1; Flat B on G/F of Tower 2 for Garden Apartment on G/F of Tower 2; Flat B on G/F of Tower 3 for Garden Apartment on G/F of Tower 3; Flat A on G/F of Tower 7 for Garden Apartment on G/F of Tower 7; Penthouse on 11/F of Tower 7 for Courtyard Penthouse on 11/F of Tower 7; Flat B on G/F of Tower 8 for Garden Apartment on G/F of Tower 8; Penthouse on 11/F of Tower 8 for Courtyard Penthouse on 11/F of Tower 8.

#### 備註:

- 上表內之「—」代表「不提供」。
- 上表內之「/」代表「不適用」。
- 「Terrace Apartment」、「Garden Apartment」及「Courtyard Penthouse」僅為市場推廣之用的名稱，並不會於關於發展項目的任何公契、臨時買賣合約、買賣合約、轉讓契及契據出現。經批准的建築圖則上顯示的名稱為：第1座1樓A單位（即第1座1樓Terrace Apartment）；第2座地下B單位（即第2座地下Garden Apartment）；第3座地下B單位（即第3座地下Garden Apartment）；第7座地下A單位（即第7座地下Garden Apartment）；第7座11樓Penthouse（即第7座11樓Courtyard Penthouse）；第8座地下B單位（即第8座地下Garden Apartment）；第8座11樓Penthouse（即第8座11樓Courtyard Penthouse）。



# FITTINGS, FINISHES AND APPLIANCES

## 裝置、裝修物料及設備

### Schedule of Mechanical & Electrical Provisions for Residential Property

#### 住宅單位機電裝置數量說明表

Location 位置	Provisions 裝置	Tower 1 第1座					
		G/F - 1/F 地下至1樓	1/F 1樓	2/F 2樓		3/F, 5/F - 10/F 3樓、5樓至 10樓	11/F 11樓
		Garden Duplex	• Terrace Apartment	Flat A A單位	Flat B B單位	Flat A & B A及B單位	Sky Pool Penthouse
Kitchen 廚房	Gas Water Heater Remote Controller 煤氣熱水爐恆溫掣	1	1	1	1	1	1
	Door Bell 門鈴	1	1	1	1	1	1
	Window Contact 窗磁控感應器	1	—	—	—	—	—
	Door Contact 門磁控感應器	1	—	—	—	—	—
	Breakglass Sensor 玻璃碎裂感應器	1	—	—	—	—	—
	Siren Bell with Strobe Light 閃燈警報器	1	—	—	—	—	—
	Town Gas Connection Point 煤氣接駁點	1	1	1	1	1	1
	Water Inlet / Outlet Connection Point for Dish Washer 洗碗機來 / 去水位接駁點	1	—	—	—	—	1
	Water Inlet / Outlet Connection Point for Washing Machine 洗衣機來 / 去水位接駁點	—	1	1	1	1	1
Store Room 2 儲物室2	Lighting Point 燈位	1	/	/	/	/	1
	Lighting Switch 燈掣	1	/	/	/	/	2
	Twin Socket Outlet 雙位電插座	1	/	/	/	/	1
Store Room 3 儲物室3	Single Socket Outlet 單位電插座	—	/	/	/	/	/
	Twin Socket Outlet 雙位電插座	—	/	/	/	/	/
	Lighting Point 燈位	1	/	/	/	/	/
	Lighting Switch 燈掣	1	/	/	/	/	/
Master Bathroom 主人浴室	Single Socket Outlet 單位電插座	1	1	1	1	1	2
	Twin Socket Outlet 雙位電插座	1	1	1	1	1	1
	TV/ FM Outlet 電視 / 電台天線插座	1	1	1	1	1	1
	Lighting Point 燈位	11	6	6	6	6	10
	Gas Water Heater Remote Controller 煤氣熱水爐恆溫掣	1	1	1	1	1	1
	Switch for Thermal Ventilator 浴室寶開關	1	1	1	1	1	1
	Fused Spur Unit for Motorized Curtain 電動窗簾保險絲接線位	1	1	1	1	1	1
	Fused Spur Unit 保險絲接線位	3	3	3	3	3	3
	Break Glass Sensor 玻璃破碎感應器	—	—	—	—	—	—
Window Contact 窗磁控感應器	—	—	—	—	—	—	

#### Notes:

- The symbol “—” as shown in the above table denotes “Not provided”.
- The symbol “/” as shown in the above table denotes “Not applicable”.
- “Terrace Apartment”, “Garden Apartment” and “Courtyard Penthouse” are names for marketing purposes only and will not appear in any Deed of Mutual Covenant, the Preliminary Agreement for Sale and Purchase, Agreement for Sale and Purchase, Assignment, or any other title deeds and documents relating to the Development. The names as appearing on the approved building plans are: Flat A on 1/F of Tower 1 for Terrace Apartment on 1/F of Tower 1; Flat B on G/F of Tower 2 for Garden Apartment on G/F of Tower 2; Flat B on G/F of Tower 3 for Garden Apartment on G/F of Tower 3; Flat A on G/F of Tower 7 for Garden Apartment on G/F of Tower 7; Penthouse on 11/F of Tower 7 for Courtyard Penthouse on 11/F of Tower 7; Flat B on G/F of Tower 8 for Garden Apartment on G/F of Tower 8; Penthouse on 11/F of Tower 8 for Courtyard Penthouse on 11/F of Tower 8.

#### 備註:

- 上表內之「—」代表「不提供」。
- 上表內之「/」代表「不適用」。
- 「Terrace Apartment」、「Garden Apartment」及「Courtyard Penthouse」僅為市場推廣之用的名稱，並不會於關於發展項目的任何公契、臨時買賣合約、買賣合約、轉讓契及契據出現。經批准的建築圖則上顯示的名稱為：第1座1樓A單位（即第1座1樓Terrace Apartment）；第2座地下B單位（即第2座地下Garden Apartment）；第3座地下B單位（即第3座地下Garden Apartment）；第7座地下A單位（即第7座地下Garden Apartment）；第7座11樓Penthouse（即第7座11樓Courtyard Penthouse）；第8座地下B單位（即第8座地下Garden Apartment）；第8座11樓Penthouse（即第8座11樓Courtyard Penthouse）。

## FITTINGS, FINISHES AND APPLIANCES

### 裝置、裝修物料及設備

#### Schedule of Mechanical & Electrical Provisions for Residential Property

#### 住宅單位機電裝置數量說明表

Location 位置	Provisions 裝置	Tower 1 第1座					
		G/F - 1/F 地下至1樓	1/F 1樓	2/F 2樓		3/F, 5/F - 10/F 3樓、5樓至 10樓	11/F 11樓
		Garden Duplex	• Terrace Apartment	Flat A A單位	Flat B B單位	Flat A & B A及B單位	Sky Pool Penthouse
Bathroom 1 浴室1	Twin Socket Outlet 雙位電插座	1	1	1	1	1	1
	Lighting Point 燈位	3	3	3	3	3	3
	Gas Water Heater Remote Controller 煤氣熱水爐恆溫掣	1	1	1	1	1	1
	Fused Spur Unit 保險絲接線位	2	2	2	2	2	2
Bathroom 2 浴室2	Twin Socket Outlet 雙位電插座	1	1	1	1	1	1
	Lighting Point 燈位	3	3	3	3	3	3
	Gas Water Heater Remote Controller 煤氣熱水爐恆溫掣	1	1	1	1	1	1
	Fused Spur Unit 保險絲接線位	2	2	2	2	2	2
	Break Glass Sensor 玻璃破碎感應器	—	—	—	—	—	—
	Door Contact 門磁控感應器	—	—	—	—	—	—
Bathroom 3 浴室3	Twin Socket Outlet 雙位電插座	1	1	1	1	1	1
	Lighting Point 燈位	3	3	3	3	3	3
	Gas Water Heater Remote Controller 煤氣熱水爐恆溫掣	1	1	1	1	1	1
	Fused Spur Unit 保險絲接線位	2	2	2	2	2	2
Powder Room 客廳洗手間	Lighting Point 燈位	2	2	2	2	2	2
	Fused Spur Unit 保險絲接線位	2	2	2	2	2	2
Store Room 1 儲物室 1	Lighting Switch 燈掣						1
	Lighting Point 燈位						1

#### Notes:

- The symbol “—” as shown in the above table denotes “Not provided”.
- The symbol “/” as shown in the above table denotes “Not applicable”.
- “Terrace Apartment”, “Garden Apartment” and “Courtyard Penthouse” are names for marketing purposes only and will not appear in any Deed of Mutual Covenant, the Preliminary Agreement for Sale and Purchase, Agreement for Sale and Purchase, Assignment, or any other title deeds and documents relating to the Development. The names as appearing on the approved building plans are: Flat A on 1/F of Tower 1 for Terrace Apartment on 1/F of Tower 1; Flat B on G/F of Tower 2 for Garden Apartment on G/F of Tower 2; Flat B on G/F of Tower 3 for Garden Apartment on G/F of Tower 3; Flat A on G/F of Tower 7 for Garden Apartment on G/F of Tower 7; Penthouse on 11/F of Tower 7 for Courtyard Penthouse on 11/F of Tower 7; Flat B on G/F of Tower 8 for Garden Apartment on G/F of Tower 8; Penthouse on 11/F of Tower 8 for Courtyard Penthouse on 11/F of Tower 8.

#### 備註:

- 上表內之「—」代表「不提供」。
- 上表內之「/」代表「不適用」。
- 「Terrace Apartment」、「Garden Apartment」及「Courtyard Penthouse」僅為市場推廣之用的名稱，並不會於關於發展項目的任何公契、臨時買賣合約、買賣合約、轉讓契及契據出現。經批准的建築圖則上顯示的名稱為：第1座1樓A單位（即第1座1樓Terrace Apartment）；第2座地下B單位（即第2座地下Garden Apartment）；第3座地下B單位（即第3座地下Garden Apartment）；第7座地下A單位（即第7座地下Garden Apartment）；第7座11樓Penthouse（即第7座11樓Courtyard Penthouse）；第8座地下B單位（即第8座地下Garden Apartment）；第8座11樓Penthouse（即第8座11樓Courtyard Penthouse）。

# FITTINGS, FINISHES AND APPLIANCES

## 裝置、裝修物料及設備

### Schedule of Mechanical & Electrical Provisions for Residential Property

#### 住宅單位機電裝置數量說明表

Location 位置	Provisions 裝置	Tower 1 第1座					
		G/F - 1/F 地下至1樓	1/F 1樓	2/F 2樓		3/F, 5/F - 10/F 3樓、5樓至 10樓	11/F 11樓
		Garden Duplex	• Terrace Apartment	Flat A A單位	Flat B B單位	Flat A & B A及B單位	Sky Pool Penthouse
Store Room 1 with Lavatory 附有洗手間之儲物室	Break Glass Sensor 玻璃破碎感應器	1	/	/	/	/	/
	Window Contact 窗磁控感應器	1	/	/	/	/	/
	Twin Socket Outlet 雙位電插座	1	/	/	/	/	/
	Lighting Point 燈位	2	/	/	/	/	/
	Lighting Switch 燈掣	2	/	/	/	/	/
	Switch for Exhaust Fan 抽氣扇開關掣	1	/	/	/	/	/
	Fused Spur Unit 保險絲接線位	3	/	/	/	/	/
	Switch for AC indoor Unit 空調室內機開關	1	/	/	/	/	/
	Air-conditioner Central Controller 冷氣中央控制器	1	/	/	/	/	/
	Miniature Circuit Breaker Board 微型斷路箱	1	/	/	/	/	/
	Tower Gas Meter 煤氣計量錶	1	/	/	/	/	/
	Security System Control Panel 保安系統控制箱	1	/	/	/	/	/
Utility Room with Lavatory 附有洗手間之工作間	Twin Socket Outlet 雙位電插座	/	1	1	1	1	1
	Lighting Point 燈位	/	2	2	2	2	2
	Lighting Switch 燈掣	/	2	2	2	2	2
	Switch for Exhaust Fan 抽氣扇開關掣	/	1	1	1	1	1
	F used Spur Unit 保險絲接線位	/	3	3	3	3	3
	Switch for AC indoor Unit 空調室內機開關	/	1	1	1	1	1
	Air-conditioner Central Controller 冷氣中央控制器	/	—	—	—	—	1
	Window Contact 窗磁控感應器	/	—	—	—	—	—
	Break Glass Sensor 玻璃破碎感應器	/	—	—	—	—	—
	Miniature Circuit Breaker Board 微型斷路箱	/	1	1	1	1	1
	Tower Gas Meter 煤氣計量錶	/	1	1	1	1	1
	Security System Control Panel 保安系統控制器	/	—	—	—	—	—

#### Notes:

- The symbol “—” as shown in the above table denotes “Not provided”.
- The symbol “/” as shown in the above table denotes “Not applicable”.
- “Terrace Apartment”, “Garden Apartment” and “Courtyard Penthouse” are names for marketing purposes only and will not appear in any Deed of Mutual Covenant, the Preliminary Agreement for Sale and Purchase, Agreement for Sale and Purchase, Assignment, or any other title deeds and documents relating to the Development. The names as appearing on the approved building plans are: Flat A on 1/F of Tower 1 for Terrace Apartment on 1/F of Tower 1; Flat B on G/F of Tower 2 for Garden Apartment on G/F of Tower 2; Flat B on G/F of Tower 3 for Garden Apartment on G/F of Tower 3; Flat A on G/F of Tower 7 for Garden Apartment on G/F of Tower 7; Penthouse on 11/F of Tower 7 for Courtyard Penthouse on 11/F of Tower 7; Flat B on G/F of Tower 8 for Garden Apartment on G/F of Tower 8; Penthouse on 11/F of Tower 8 for Courtyard Penthouse on 11/F of Tower 8.

#### 備註:

- 上表內之「—」代表「不提供」。
- 上表內之「/」代表「不適用」。
- 「Terrace Apartment」、「Garden Apartment」及「Courtyard Penthouse」僅為市場推廣之用的名稱，並不會於關於發展項目的任何公契、臨時買賣合約、買賣合約、轉讓契及契據出現。經批准的建築圖則上顯示的名稱為：第1座1樓A單位（即第1座1樓Terrace Apartment）；第2座地下B單位（即第2座地下Garden Apartment）；第3座地下B單位（即第3座地下Garden Apartment）；第7座地下A單位（即第7座地下Garden Apartment）；第7座11樓Penthouse（即第7座11樓Courtyard Penthouse）；第8座地下B單位（即第8座地下Garden Apartment）；第8座11樓Penthouse（即第8座11樓Courtyard Penthouse）。

FITTINGS, FINISHES AND APPLIANCES

裝置、裝修物料及設備

Schedule of Mechanical & Electrical Provisions for Residential Property

住宅單位機電裝置數量說明表

Location 位置	Provisions 裝置	Tower 1 第1座					
		G/F - 1/F 地下至1樓	1/F 1樓	2/F 2樓		3/F, 5/F - 10/F 3樓、5樓至 10樓	11/F 11樓
		Garden Duplex	• Terrace Apartment	Flat A A單位	Flat B B單位	Flat A & B A及B單位	Sky Pool Penthouse
Utility Platform 工作平台	Lighting Point 燈位	/	/	1	1	1	1
Air-Conditioner Platform (next to Utility Room) 冷氣機平台 (工作間旁)	Switch for A/C Outdoor Unit 冷氣室外機開關	/	5	5	5	5	/
Balcony 露台	Lighting Point 燈位	1	1	1	1	1	1
Flat Roof 平台	Lighting Point 燈位	/	1	/	/	/	8
	Fused Spur Unit 保險絲接線位	/	—	/	/	/	1
	Switch for A/C Outdoor Unit 冷氣室外機開關	/	—	/	1	/	—
	Switch for Filtration Plant 泳池過濾系統開關	/	—	/	/	/	1
	Underwater Lighting in Swimming Pool 泳池水下燈	/	—	/	/	/	8
	Water Inlet Connection Point for Swimming Pool Filtration Cabinet 游泳池過濾櫃來水位接駁點	/	—	/	/	/	1
	Water Outlet Connection Point for Swimming Pool Filtration Cabinet 游泳池過濾櫃去水位接駁點	/	—	/	/	/	2
Air-Conditioner Platform (next to Powder Room) 冷氣機平台 (客廳洗手間旁)	Switch for AC Outdoor Unit 空調室外機開關	/	/	1	/	1	/
Roof 天台	Lighting Point 燈位	/	/	/	/	/	12
	Fused Spar Unit 保險絲接線位	/	/	/	/	/	1
	Single Waterproof Socket Outlet 防水單位電插座	/	/	/	/	/	1
Flat Roof for Ensuite 1 & 3 套房1及3平台	Lighting Point 燈位	/	1	/	/	/	/
	Switch for A/C Outdoor Unit 冷氣室外機開關	/	1	/	/	/	/
Garden & Front Garden 花園	Lighting Point 燈位	10	/	/	/	/	/
	Single Waterproof Socket Outlet 防水單位電插座	1	/	/	/	/	/
	Video Door Phone 視像對講機	1	/	/	/	/	/
	Motion Sensor 移動感測器	3	/	/	/	/	/
Outdoor VRV Area 室外變頻中央空調系統空間	Lighting Point 燈位	—	/	/	/	/	1
	Switch for A/C Outdoor Unit 冷氣室外機開關	2	/	/	/	/	2
Flat Roof 平台 (Master Bedroom 主人睡房)	Lighting Point 燈位	/	/	/	/	/	2

Notes:

- The symbol “ — ” as shown in the above table denotes “Not provided”.
- The symbol “ / ” as shown in the above table denotes “Not applicable”.
- “Terrace Apartment”, “Garden Apartment” and “Courtyard Penthouse” are names for marketing purposes only and will not appear in any Deed of Mutual Covenant, the Preliminary Agreement for Sale and Purchase, Agreement for Sale and Purchase, Assignment, or any other title deeds and documents relating to the Development. The names as appearing on the approved building plans are: Flat A on 1/F of Tower 1 for Terrace Apartment on 1/F of Tower 1; Flat B on G/F of Tower 2 for Garden Apartment on G/F of Tower 2; Flat B on G/F of Tower 3 for Garden Apartment on G/F of Tower 3; Flat A on G/F of Tower 7 for Garden Apartment on G/F of Tower 7; Penthouse on 11/F of Tower 7 for Courtyard Penthouse on 11/F of Tower 7; Flat B on G/F of Tower 8 for Garden Apartment on G/F of Tower 8; Penthouse on 11/F of Tower 8 for Courtyard Penthouse on 11/F of Tower 8.

備註:

- 上表內之「—」代表「不提供」。
- 上表內之「/」代表「不適用」。
- 「Terrace Apartment」、「Garden Apartment」及「Courtyard Penthouse」僅為市場推廣之用的名稱，並不會於關於發展項目的任何公契、臨時買賣合約、買賣合約、轉讓契及契據出現。經批准的建築圖則上顯示的名稱為：第1座1樓A單位（即第1座1樓Terrace Apartment）；第2座地下B單位（即第2座地下Garden Apartment）；第3座地下B單位（即第3座地下Garden Apartment）；第7座地下A單位（即第7座地下Garden Apartment）；第7座11樓Penthouse（即第7座11樓Courtyard Penthouse）；第8座地下B單位（即第8座地下Garden Apartment）；第8座11樓Penthouse（即第8座11樓Courtyard Penthouse）。



# FITTINGS, FINISHES AND APPLIANCES

## 裝置、裝修物料及設備

### Schedule of Mechanical & Electrical Provisions for Residential Property

#### 住宅單位機電裝置數量說明表

Location 位置	Provisions 裝置	Tower 2 第2座						
		G/F - 1/F 地下至1樓	G/F 地下	1/F 1樓	2/F - 3/F, 5/F - 6/F & 9/F 2樓至3樓、 5樓至6樓及 9樓	7/F & 8/F 7樓至8樓		10/F - 11/F 10樓至11樓
		Garden Duplex	• Garden Apartment	Flat B B單位	Flat A & B A及B單位	Flat A A單位	Flat B B單位	Spa Duplex A&B
Private Lift Lobby 私人電梯大堂	Lighting Point 燈位	/	/	4	4	4	4	4
	Lighting Switch 燈掣	—	—	—	—	—	1	—
	Door Bell Push Button 門鈴按鈕	/	/	1	1	1	1	1
	Fused Spur Unit 保險絲接線位	/	/	1	1	1	1	1
Living Room & Dining Room 客廳及飯廳	Single Socket Outlet 單位電插座	3	1	1	1	1	6	2
	Twin Socket Outlet 雙位電插座	4	3	3	3	3	6	5
	Telephone Outlet 電話插座	2	2	2	2	2	3	2
	TV/ FM Outlet 電視 / 電台天線插座	2	2	2	2	2	3	2
	Window Contact 窗磁控感應器	1	—	—	—	—	—	—
	Door Contact 門磁控感應器	4	3	—	—	—	—	—
	Breakglass Sensor 玻璃碎裂感應器	3	2	—	—	—	—	—
	Lighting Point 燈位	14	4	4	4	4	21	7
	Lighting Switch 燈掣	7	6	7	7	7	7	8
	Fused Spur Unit for Motorized Curtain 電動窗簾保險絲接線位	1	—	1	1	1	—	2
	Fused Spur Unit 保險絲接線位	2	—	—	—	—	5	1
	Switch for AC indoor Unit 空調室內機開關	4	2	2	2	2	3	4
	Switch for Oven 焗爐開關制	1	—	—	—	—	—	1
	Switch for Steamer 蒸爐開關掣	1	—	—	—	—	—	1
	Switch for Exhaust Fan 抽氣扇開關掣	2	2	2	2	2	2	2
	Security System Control Keypad 保安系統鍵盤控制面板	1	1	—	—	—	—	—
	Video Door phone 視像對講機	1	1	—	—	—	—	1
	Door Phone 門口對講機	—	—	1	1	1	1	—
Water Inlet / Outlet Connection Point for Washing Machine 洗衣機來 / 去水位接駁點	1	—	—	—	—	—	—	
Hallway 走廊/門廳	Single Socket Outlet 單位電插座	1	/	/	/	/	/	1
	Twin Socket Outlet 雙位電插座	1	/	/	/	/	/	—
	Telephone Outlet 電話插座	1	/	/	/	/	/	—
	TV/ FM Outlet 電視 / 電台天線插座	1	/	/	/	/	/	—
	Lighting Point 燈位	4	/	/	/	/	/	3
	Lighting Switch 燈掣	5	/	/	/	/	/	2

#### Notes:

- The symbol “ — ” as shown in the above table denotes “Not provided”.
- The symbol “ / ” as shown in the above table denotes “Not applicable”.
- “Terrace Apartment”, “Garden Apartment” and “Courtyard Penthouse” are names for marketing purposes only and will not appear in any Deed of Mutual Covenant, the Preliminary Agreement for Sale and Purchase, Agreement for Sale and Purchase, Assignment, or any other title deeds and documents relating to the Development. The names as appearing on the approved building plans are: Flat A on 1/F of Tower 1 for Terrace Apartment on 1/F of Tower 1; Flat B on G/F of Tower 2 for Garden Apartment on G/F of Tower 2; Flat B on G/F of Tower 3 for Garden Apartment on G/F of Tower 3; Flat A on G/F of Tower 7 for Garden Apartment on G/F of Tower 7; Penthouse on 11/F of Tower 7 for Courtyard Penthouse on 11/F of Tower 7; Flat B on G/F of Tower 8 for Garden Apartment on G/F of Tower 8; Penthouse on 11/F of Tower 8 for Courtyard Penthouse on 11/F of Tower 8.

#### 備註:

- 上表內之「—」代表「不提供」。
- 上表內之「/」代表「不適用」。
- 「Terrace Apartment」、「Garden Apartment」及「Courtyard Penthouse」僅為市場推廣之用的名稱，並不會於關於發展項目的任何公契、臨時買賣合約、買賣合約、轉讓契及契據出現。經批准的建築圖則上顯示的名稱為：第1座1樓A單位（即第1座1樓Terrace Apartment）；第2座地下B單位（即第2座地下Garden Apartment）；第3座地下B單位（即第3座地下Garden Apartment）；第7座地下A單位（即第7座地下Garden Apartment）；第7座11樓Penthouse（即第7座11樓Courtyard Penthouse）；第8座地下B單位（即第8座地下Garden Apartment）；第8座11樓Penthouse（即第8座11樓Courtyard Penthouse）。



# FITTINGS, FINISHES AND APPLIANCES

## 裝置、裝修物料及設備

### Schedule of Mechanical & Electrical Provisions for Residential Property

#### 住宅單位機電裝置數量說明表

Location 位置	Provisions 裝置	Tower 2 第2座						
		G/F - 1/F 地下至1樓	G/F 地下	1/F 1樓	2/F - 3/F, 5/F - 6/F & 9/F 2樓至3樓、 5樓至6樓及 9樓	7/F & 8/F 7樓至8樓		10/F - 11/F 10樓至11樓
		Garden Duplex	• Garden Apartment	Flat B B單位	Flat A & B A及B單位	Flat A A單位	Flat B B單位	Spa Duplex A&B
Staircase 樓梯	Lighting Point 燈位	1						1
Entrance Lobby 電梯大堂	Door Bell Push Button 門鈴按鈕	1	1					
Master Bedroom 主人睡房	Twin Socket Outlet 雙位電插座	2	2	2	2	2	3	2
	Single Socket Outlet 單位電插座	—	—	—	—	—	2	—
	Telephone Outlet 電話插座	2	2	2	2	2	2	2
	TV/ FM Outlet 電視 / 電台天線插座	2	2	2	2	2	2	2
	Panic Alarm Button 警鐘按鈕	1	1	1	1	1	1	1
	Lighting Point 燈位	1	1	1	1	1	—	1
	Lighting Switch 燈掣	4	3	3	2	2	3	4
	Fused Spur Unit for Motorized Curtain 電動窗簾保險絲接線位	1	1	1	1	1	—	1
	Switch for AC indoor Unit 空調室內機開關	2	1	1	1	1	1	2
	Switch for Exhaust Fan 抽氣扇開關掣	1	—	—	—	—	1	1
	Fused Spur Unit 保險絲接線位	—	—	—	—	—	2	—
	Door Contact 門磁控感應器	—	1	—	—	—	—	—
Breakglass Sensor 玻璃碎裂感應器	—	1	—	—	—	—	—	
Ensuite 1 套房 1	Twin Socket Outlet 雙位電插座	2	2	2	2	2	4	2
	Single Socket Outlet 單位電插座	—	—	—	—	—	1	—
	Telephone Outlet 電話插座	1	1	1	1	1	1	1
	TV/ FM Outlet 電視 / 電台天線插座	1	1	1	1	1	1	1
	Lighting Point 燈位	1	1	1	1	1	—	1
	Lighting Switch 燈掣	2	3	2	2	2	4	2
	Switch for AC indoor Unit 空調室內機開關	1	1	1	1	1	1	1
	Switch for Exhaust Fan 抽氣扇開關掣	1	1	1	1	1	1	1
	Fused Spur Unit 保險絲接線位	—	—	—	—	—	2	—
	Window Contact 窗磁控感應器	—	—	—	—	—	—	—
	Door Contact 門磁控感應器	—	1	—	—	—	—	—
	Breakglass Sensor 玻璃碎裂感應器	—	1	—	—	—	—	—

#### Notes:

- The symbol “ — ” as shown in the above table denotes “Not provided”.
- The symbol “ / ” as shown in the above table denotes “Not applicable”.
- “Terrace Apartment”, “Garden Apartment” and “Courtyard Penthouse” are names for marketing purposes only and will not appear in any Deed of Mutual Covenant, the Preliminary Agreement for Sale and Purchase, Agreement for Sale and Purchase, Assignment, or any other title deeds and documents relating to the Development. The names as appearing on the approved building plans are: Flat A on 1/F of Tower 1 for Terrace Apartment on 1/F of Tower 1; Flat B on G/F of Tower 2 for Garden Apartment on G/F of Tower 2; Flat B on G/F of Tower 3 for Garden Apartment on G/F of Tower 3; Flat A on G/F of Tower 7 for Garden Apartment on G/F of Tower 7; Penthouse on 11/F of Tower 7 for Courtyard Penthouse on 11/F of Tower 7; Flat B on G/F of Tower 8 for Garden Apartment on G/F of Tower 8; Penthouse on 11/F of Tower 8 for Courtyard Penthouse on 11/F of Tower 8.

#### 備註:

- 上表內之「—」代表「不提供」。
- 上表內之「/」代表「不適用」。
- 「Terrace Apartment」、「Garden Apartment」及「Courtyard Penthouse」僅為市場推廣之用的名稱，並不會於關於發展項目的任何公契、臨時買賣合約、買賣合約、轉讓契及契據出現。經批准的建築圖則上顯示的名稱為：第1座1樓A單位（即第1座1樓Terrace Apartment）；第2座地下B單位（即第2座地下Garden Apartment）；第3座地下B單位（即第3座地下Garden Apartment）；第7座地下A單位（即第7座地下Garden Apartment）；第7座11樓Penthouse（即第7座11樓Courtyard Penthouse）；第8座地下B單位（即第8座地下Garden Apartment）；第8座11樓Penthouse（即第8座11樓Courtyard Penthouse）。

## FITTINGS, FINISHES AND APPLIANCES

### 裝置、裝修物料及設備

#### Schedule of Mechanical & Electrical Provisions for Residential Property

#### 住宅單位機電裝置數量說明表

Location 位置	Provisions 裝置	Tower 2 第2座						
		G/F - 1/F 地下至1樓	G/F 地下	1/F 1樓	2/F - 3/F, 5/F - 6/F & 9/F 2樓至3樓、 5樓至6樓及 9樓	7/F & 8/F 7樓至8樓		10/F - 11/F 10樓至11樓
		Garden Duplex	• Garden Apartment	Flat B B單位	Flat A & B A及B單位	Flat A A單位	Flat B B單位	Spa Duplex A&B
Ensuite 2 套房 2	Twin Socket Outlet 雙位電插座	2	2	2	2	2	3	2
	Single Socket Outlet 單位電插座	—	—	—	—	—	1	—
	Telephone Outlet 電話插座	1	1	1	1	1	1	1
	TV/ FM Outlet 電視 / 電台天線插座	1	1	1	1	1	1	1
	Lighting Point 燈位	1	1	1	1	1	—	1
	Lighting Switch 燈掣	2	2	3	3	3	3	2
	Switch for AC indoor Unit 空調室內機開關	1	1	1	1	1	1	1
	Switch for Exhaust Fan 抽氣扇開關掣	1	1	1	1	1	1	1
	Fused Spur Unit 保險絲接線位	—	—	—	—	—	2	—
	Door Contact 門磁控感應器	—	1	—	—	—	—	—
	Window Contact 窗磁控感應器	—	—	—	—	—	—	—
	Breakglass Sensor 玻璃碎裂感應器	—	1	—	—	—	—	—
Ensuite 3 套房 3	Twin Socket Outlet 雙位電插座	2	2	2	2	2	/	2
	Telephone Outlet 電話插座	1	1	1	1	1	/	1
	TV/ FM Outlet 電視 / 電台天線插座	1	1	1	1	1	/	1
	Lighting Point 燈位	1	1	1	1	1	/	1
	Lighting Switch 燈掣	2	2	2	2	2	/	2
	Switch for AC indoor Unit 空調室內機開關	1	1	1	1	1	/	1
	Switch for Exhaust Fan 抽氣扇開關掣	1	1	1	1	1	/	1
	Door Contact 門磁控感應器	—	1	—	—	—	/	—
	Window Contact 窗磁控感應器	—	1	—	—	—	/	—
Breakglass Sensor 玻璃碎裂感應器	—	1	—	—	—	/	—	

#### Notes:

- The symbol “ — ” as shown in the above table denotes “Not provided”.
- The symbol “ / ” as shown in the above table denotes “Not applicable”.
- “Terrace Apartment”, “Garden Apartment” and “Courtyard Penthouse” are names for marketing purposes only and will not appear in any Deed of Mutual Covenant, the Preliminary Agreement for Sale and Purchase, Agreement for Sale and Purchase, Assignment, or any other title deeds and documents relating to the Development. The names as appearing on the approved building plans are: Flat A on 1/F of Tower 1 for Terrace Apartment on 1/F of Tower 1; Flat B on G/F of Tower 2 for Garden Apartment on G/F of Tower 2; Flat B on G/F of Tower 3 for Garden Apartment on G/F of Tower 3; Flat A on G/F of Tower 7 for Garden Apartment on G/F of Tower 7; Penthouse on 11/F of Tower 7 for Courtyard Penthouse on 11/F of Tower 7; Flat B on G/F of Tower 8 for Garden Apartment on G/F of Tower 8; Penthouse on 11/F of Tower 8 for Courtyard Penthouse on 11/F of Tower 8.

#### 備註:

- 上表內之「—」代表「不提供」。
- 上表內之「/」代表「不適用」。
- 「Terrace Apartment」、「Garden Apartment」及「Courtyard Penthouse」僅為市場推廣之用的名稱，並不會於關於發展項目的任何公契、臨時買賣合約、買賣合約、轉讓契及契據出現。經批准的建築圖則上顯示的名稱為：第1座1樓A單位（即第1座1樓Terrace Apartment）；第2座地下B單位（即第2座地下Garden Apartment）；第3座地下B單位（即第3座地下Garden Apartment）；第7座地下A單位（即第7座地下Garden Apartment）；第7座11樓Penthouse（即第7座11樓Courtyard Penthouse）；第8座地下B單位（即第8座地下Garden Apartment）；第8座11樓Penthouse（即第8座11樓Courtyard Penthouse）。

# FITTINGS, FINISHES AND APPLIANCES

## 裝置、裝修物料及設備

### Schedule of Mechanical & Electrical Provisions for Residential Property

#### 住宅單位機電裝置數量說明表

Location 位置	Provisions 裝置	Tower 2 第2座						
		G/F - 1/F 地下至1樓	G/F 地下	1/F 1樓	2/F - 3/F, 5/F - 6/F & 9/F 2樓至3樓、 5樓至6樓及 9樓	7/F & 8/F 7樓至8樓		10/F - 11/F 10樓至11樓
		Garden Duplex	• Garden Apartment	Flat B B單位	Flat A & B A及B單位	Flat A A單位	Flat B B單位	Spa Duplex A&B
Kitchen 廚房	Single Socket Outlet 單位電插座	2	3	3	3	3	3	2
	Twin Socket Outlet 雙位電插座	2	4	5	5	5	5	3
	Lighting Point 燈位	4	8	7	7	7	7	7
	Lighting Switch 燈掣	—	—	—	—	—	—	—
	Switch for Oven 焗爐開關制	—	1	1	1	1	1	—
	Switch for Steamer 蒸爐開關掣	—	1	—	—	—	—	—
	Switch for Induction Cooker 電磁爐開關制	1	1	1	1	1	1	1
	Fused Spur Unit 保險絲接線位	5	6	6	6	6	6	6
	Switch for AC indoor Unit 空調室內機開關	1	1	1	1	1	1	1
	Gas Water Heater Remote Controller 煤氣熱水爐恆溫掣	1	1	1	1	1	1	1
	Door Bell 門鈴	1	1	1	1	1	1	1
	Door Contact 門磁控感應器	2	1	—	—	—	—	—
	Window Contact 窗磁控感應器	2	1	—	—	—	—	—
	Breakglass Sensor 玻璃碎裂感應器	1	1	—	—	—	—	—
	Siren Bell with Strobe Light 閃燈警報器	1	1	—	—	—	—	—
	Town Gas Connection Point 煤氣接駁點	1	1	1	1	1	1	1
	Water Inlet / Outlet Connection Point for Dish Washer 洗碗機來 / 去水位接駁點	1	1	—	—	—	—	1
Water Inlet / Outlet Connection Point for Washing Machine 洗衣機來 / 去水位接駁點	—	1	1	1	1	1	1	
Store Room 1 儲物室1	Lighting Point 燈位							1
	Lighting Switch 燈掣							1
Store Room 2 儲物室2	Lighting Point 燈位	1						1
	Lighting Switch 燈掣	1						1

#### Notes:

- The symbol “ — ” as shown in the above table denotes “Not provided”.
- The symbol “ / ” as shown in the above table denotes “Not applicable”.
- “Terrace Apartment”, “Garden Apartment” and “Courtyard Penthouse” are names for marketing purposes only and will not appear in any Deed of Mutual Covenant, the Preliminary Agreement for Sale and Purchase, Agreement for Sale and Purchase, Assignment, or any other title deeds and documents relating to the Development. The names as appearing on the approved building plans are: Flat A on 1/F of Tower 1 for Terrace Apartment on 1/F of Tower 1; Flat B on G/F of Tower 2 for Garden Apartment on G/F of Tower 2; Flat B on G/F of Tower 3 for Garden Apartment on G/F of Tower 3; Flat A on G/F of Tower 7 for Garden Apartment on G/F of Tower 7; Penthouse on 11/F of Tower 7 for Courtyard Penthouse on 11/F of Tower 7; Flat B on G/F of Tower 8 for Garden Apartment on G/F of Tower 8; Penthouse on 11/F of Tower 8 for Courtyard Penthouse on 11/F of Tower 8.

#### 備註:

- 上表內之「—」代表「不提供」。
- 上表內之「/」代表「不適用」。
- 「Terrace Apartment」、「Garden Apartment」及「Courtyard Penthouse」僅為市場推廣之用的名稱，並不會於關於發展項目的任何公契、臨時買賣合約、買賣合約、轉讓契及契據出現。經批准的建築圖則上顯示的名稱為：第1座1樓A單位（即第1座1樓Terrace Apartment）；第2座地下B單位（即第2座地下Garden Apartment）；第3座地下B單位（即第3座地下Garden Apartment）；第7座地下A單位（即第7座地下Garden Apartment）；第7座11樓Penthouse（即第7座11樓Courtyard Penthouse）；第8座地下B單位（即第8座地下Garden Apartment）；第8座11樓Penthouse（即第8座11樓Courtyard Penthouse）。

# FITTINGS, FINISHES AND APPLIANCES

## 裝置、裝修物料及設備

### Schedule of Mechanical & Electrical Provisions for Residential Property

#### 住宅單位機電裝置數量說明表

Location 位置	Provisions 裝置	Tower 2 第2座						
		G/F - 1/F 地下至1樓	G/F 地下	1/F 1樓	2/F - 3/F, 5/F - 6/F & 9/F 2樓至3樓、 5樓至6樓及 9樓	7/F & 8/F 7樓至8樓		10/F - 11/F 10樓至11樓
		Garden Duplex	• Garden Apartment	Flat B B單位	Flat A & B A及B單位	Flat A A單位	Flat B B單位	Spa Duplex A&B
Master Bathroom 主人浴室	Single Socket Outlet 單位電插座	1	1	1	1	1	1	1
	Twin Socket Outlet 雙位電插座	1	1	1	1	1	1	1
	TV/ FM Outlet 電視 / 電台天線插座	1	1	1	1	1	1	1
	Lighting Point 燈位	5	6	6	6	6	3	5
	Gas Water Heater Remote Controller 煤氣熱水爐恆溫掣	1	1	1	1	1	1	1
	Switch for Thermal Ventilator 浴室寶開關	1	1	1	1	1	—	1
	Fused Spur Unit for Motorized Curtain 電動窗簾保險絲接線位	—	1	1	1	1	1	—
	Fused Spur Unit 保險絲接線位	3	3	3	3	3	2	3
	Breakglass Sensor 玻璃碎裂感應器	—	1	—	—	—	—	—
	Window Contact 窗磁控感應器	—	2	—	—	—	—	—
Powder Room 客廳洗手間	Lighting Point 燈位	2	2	3	3	3	—	2
	Fused Spur Unit 保險絲接線位	2	2	2	2	2	2	2
Bathroom 1 浴室1	Twin Socket Outlet 雙位電插座	1	1	1	1	1	1	1
	Lighting Point 燈位	3	3	3	3	3	2	3
	Gas Water Heater Remote Controller 煤氣熱水爐恆溫掣	1	1	1	1	1	1	1
	Fused Spur Unit 保險絲接線位	2	2	2	2	2	2	2
	Window Contact 窗磁控感應器	—	1	—	—	—	—	—
	Breakglass Sensor 玻璃碎裂感應器	—	1	—	—	—	—	—
Bathroom 2 浴室2	Twin Socket Outlet 雙位電插座	1	1	1	1	1	1	1
	Lighting Point 燈位	3	3	3	3	3	2	3
	Gas Water Heater Remote Controller 煤氣熱水爐恆溫掣	1	1	1	1	1	1	1
	Fused Spur Unit 保險絲接線位	2	2	2	2	2	2	2
Bathroom 3 浴室3	Twin Socket Outlet 雙位電插座	1	1	1	1	1	1	1
	Lighting Point 燈位	3	3	3	3	3	2	3
	Gas Water Heater Remote Controller 煤氣熱水爐恆溫掣	1	1	1	1	1	1	1
	Fused Spur Unit 保險絲接線位	2	2	2	2	2	2	2
Bathroom 4 浴室4	Twin Socket Outlet 雙位電插座	1						
	Lighting Point 燈位	3						
	Gas Water Heater Remote Controller 煤氣熱水爐恆溫掣	1						
	Fused Spur Unit 保險絲接線位	2						

#### Notes:

- The symbol “ — ” as shown in the above table denotes “Not provided”.
- The symbol “ / ” as shown in the above table denotes “Not applicable”.
- “Terrace Apartment”, “Garden Apartment” and “Courtyard Penthouse” are names for marketing purposes only and will not appear in any Deed of Mutual Covenant, the Preliminary Agreement for Sale and Purchase, Agreement for Sale and Purchase, Assignment, or any other title deeds and documents relating to the Development. The names as appearing on the approved building plans are: Flat A on 1/F of Tower 1 for Terrace Apartment on 1/F of Tower 1; Flat B on G/F of Tower 2 for Garden Apartment on G/F of Tower 2; Flat B on G/F of Tower 3 for Garden Apartment on G/F of Tower 3; Flat A on G/F of Tower 7 for Garden Apartment on G/F of Tower 7; Penthouse on 11/F of Tower 7 for Courtyard Penthouse on 11/F of Tower 7; Flat B on G/F of Tower 8 for Garden Apartment on G/F of Tower 8; Penthouse on 11/F of Tower 8 for Courtyard Penthouse on 11/F of Tower 8.

#### 備註:

- 上表內之「—」代表「不提供」。
- 上表內之「/」代表「不適用」。
- 「Terrace Apartment」、「Garden Apartment」及「Courtyard Penthouse」僅為市場推廣之用的名稱，並不會於關於發展項目的任何公契、臨時買賣合約、買賣合約、轉讓契及契據出現。經批准的建築圖則上顯示的名稱為：第1座1樓A單位（即第1座1樓Terrace Apartment）；第2座地下B單位（即第2座地下Garden Apartment）；第3座地下B單位（即第3座地下Garden Apartment）；第7座地下A單位（即第7座地下Garden Apartment）；第7座11樓Penthouse（即第7座11樓Courtyard Penthouse）；第8座地下B單位（即第8座地下Garden Apartment）；第8座11樓Penthouse（即第8座11樓Courtyard Penthouse）。



# FITTINGS, FINISHES AND APPLIANCES

## 裝置、裝修物料及設備

### Schedule of Mechanical & Electrical Provisions for Residential Property

#### 住宅單位機電裝置數量說明表

Location 位置	Provisions 裝置	Tower 2 第2座						
		G/F - 1/F 地下至1樓	G/F 地下	1/F 1樓	2/F - 3/F, 5/F - 6/F & 9/F 2樓至3樓、 5樓至6樓及 9樓	7/F & 8/F 7樓至8樓		10/F - 11/F 10樓至11樓
		Garden Duplex	• Garden Apartment	Flat B B單位	Flat A & B A及B單位	Flat A A單位	Flat B B單位	Spa Duplex A&B
Lavatory inside Master Bedroom 主人睡房內洗手間	Lighting Point 燈位	3						3
	Fused Spur Unit 保險絲接線位	2						2
Store Room 1 with Lavatory 附有洗手間之儲物室1	Twin Socket Outlet 雙位電插座	1						
	Lighting Point 燈位	2						
	Lighting Switch 燈掣	2						
	Switch for Exhaust Fan 抽氣扇開關掣	1						
	Fused Spur Unit 保險絲接線位	4						
	Switch for AC indoor Unit 空調室內機開關	1						
	Air-conditioner Central Controller 冷氣中央控制器	1						
	Miniature Circuit Breaker Board 微型斷路箱	1						
	Tower Gas Meter 煤氣計量錶	1						
	Security System Control Panel 保安系統控制箱	1						
	Breakglass Sensor 玻璃碎裂感應器	1						
	Window Contact 窗磁控感應器	1						
Utility Room with Lavatory 附有洗手間之工作間	Twin Socket Outlet 雙位電插座		1	1	1	1	1	1
	Lighting Point 燈位		2	2	2	2	2	2
	Lighting Switch 燈掣		2	2	2	2	2	2
	Switch for Exhaust Fan 抽氣扇開關掣		1	1	1	1	1	1
	Fused Spur Unit 保險絲接線位		2	3	3	3	3	3
	Switch for AC indoor Unit 空調室內機開關		1	1	1	1	1	1
	Air-conditioner Central Controller 冷氣中央控制器		1	—	—	—	—	1
	Miniature Circuit Breaker Board 微型斷路箱		1	1	1	1	1	1
	Security System Control Panel 保安系統控制箱		1	—	—	—	—	—
	Window Contact 窗磁控感應器		1	—	—	—	—	—
	Breakglass Sensor 玻璃碎裂感應器		1	—	—	—	—	—
	Tower Gas Meter 煤氣計量錶		1	1	1	1	1	1

#### Notes:

- The symbol “ — ” as shown in the above table denotes “Not provided”.
- The symbol “ / ” as shown in the above table denotes “Not applicable”.
- “Terrace Apartment”, “Garden Apartment” and “Courtyard Penthouse” are names for marketing purposes only and will not appear in any Deed of Mutual Covenant, the Preliminary Agreement for Sale and Purchase, Agreement for Sale and Purchase, Assignment, or any other title deeds and documents relating to the Development. The names as appearing on the approved building plans are: Flat A on 1/F of Tower 1 for Terrace Apartment on 1/F of Tower 1; Flat B on G/F of Tower 2 for Garden Apartment on G/F of Tower 2; Flat B on G/F of Tower 3 for Garden Apartment on G/F of Tower 3; Flat A on G/F of Tower 7 for Garden Apartment on G/F of Tower 7; Penthouse on 11/F of Tower 7 for Courtyard Penthouse on 11/F of Tower 7; Flat B on G/F of Tower 8 for Garden Apartment on G/F of Tower 8; Penthouse on 11/F of Tower 8 for Courtyard Penthouse on 11/F of Tower 8.

#### 備註:

- 上表內之「—」代表「不提供」。
- 上表內之「/」代表「不適用」。
- 「Terrace Apartment」、「Garden Apartment」及「Courtyard Penthouse」僅為市場推廣之用的名稱，並不會於關於發展項目的任何公契、臨時買賣合約、買賣合約、轉讓契及契據出現。經批准的建築圖則上顯示的名稱為：第1座1樓A單位（即第1座1樓Terrace Apartment）；第2座地下B單位（即第2座地下Garden Apartment）；第3座地下B單位（即第3座地下Garden Apartment）；第7座地下A單位（即第7座地下Garden Apartment）；第7座11樓Penthouse（即第7座11樓Courtyard Penthouse）；第8座地下B單位（即第8座地下Garden Apartment）；第8座11樓Penthouse（即第8座11樓Courtyard Penthouse）。



## FITTINGS, FINISHES AND APPLIANCES

### 裝置、裝修物料及設備

#### Schedule of Mechanical & Electrical Provisions for Residential Property

#### 住宅單位機電裝置數量說明表

Location 位置	Provisions 裝置	Tower 2 第2座						
		G/F - 1/F 地下至1樓	G/F 地下	1/F 1樓	2/F - 3/F, 5/F - 6/F & 9/F 2樓至3樓、 5樓至6樓及 9樓	7/F & 8/F 7樓至8樓		10/F - 11/F 10樓至11樓
		Garden Duplex	• Garden Apartment	Flat B B單位	Flat A & B A及B單位	Flat A A單位	Flat B B單位	Spa Duplex A&B
Study Room 書房	Single Socket Outlet 單位電插座	2						
	Twin Socket Outlet 雙位電插座	—						
	Telephone Outlet 電話插座	1						
	TV/ FM Outlet 電視 / 電台天線插座	1						
	Lighting Point 燈位	1						
	Lighting Switch 燈掣	2						
	On/Off Switch for Exhaust Fan 抽氣扇開關掣	1						
Switch for AC indoor Unit 空調室內機開關	1							
Study Room 1 書房1	Twin Socket Outlet 雙位電插座							1
	Lighting Point 燈位							1
	Lighting Switch 燈掣							1
	Switch for AC indoor Unit 空調室內機開關							1
Utility Platform 工作平台	Lighting Point 燈位	1		1	1	1	1	
Air-Conditioner Platform (next to Utility Room) 空調機平台 (工作間旁)	Switch for A/C Outdoor Unit 空調室外機開關			5	5	5	5	
Balcony 露台	Lighting Point 燈位	1		1	1	1	1	1
10/F Flat Roof 10樓平台	Lighting Point 燈位							7
	Single Waterproof Socket Outlet 防水單位電插座							1
	Switch for Jacuzzi 按摩浴缸開關							1
	Water Inlet Connection Point for Jacuzzi 按摩浴缸來水位接駁點							1
	Water Outlet Connection Point for Jacuzzi 按摩浴缸去水位接駁點							1

#### Notes:

- The symbol “—” as shown in the above table denotes “Not provided”.
- The symbol “/” as shown in the above table denotes “Not applicable”.
- “Terrace Apartment”, “Garden Apartment” and “Courtyard Penthouse” are names for marketing purposes only and will not appear in any Deed of Mutual Covenant, the Preliminary Agreement for Sale and Purchase, Agreement for Sale and Purchase, Assignment, or any other title deeds and documents relating to the Development. The names as appearing on the approved building plans are: Flat A on 1/F of Tower 1 for Terrace Apartment on 1/F of Tower 1; Flat B on G/F of Tower 2 for Garden Apartment on G/F of Tower 2; Flat B on G/F of Tower 3 for Garden Apartment on G/F of Tower 3; Flat A on G/F of Tower 7 for Garden Apartment on G/F of Tower 7; Penthouse on 11/F of Tower 7 for Courtyard Penthouse on 11/F of Tower 7; Flat B on G/F of Tower 8 for Garden Apartment on G/F of Tower 8; Penthouse on 11/F of Tower 8 for Courtyard Penthouse on 11/F of Tower 8.

#### 備註:

- 上表內之「—」代表「不提供」。
- 上表內之「/」代表「不適用」。
- 「Terrace Apartment」、「Garden Apartment」及「Courtyard Penthouse」僅為市場推廣之用的名稱，並不會於關於發展項目的任何公契、臨時買賣合約、買賣合約、轉讓契及契據出現。經批准的建築圖則上顯示的名稱為：第1座1樓A單位（即第1座1樓Terrace Apartment）；第2座地下B單位（即第2座地下Garden Apartment）；第3座地下B單位（即第3座地下Garden Apartment）；第7座地下A單位（即第7座地下Garden Apartment）；第7座11樓Penthouse（即第7座11樓Courtyard Penthouse）；第8座地下B單位（即第8座地下Garden Apartment）；第8座11樓Penthouse（即第8座11樓Courtyard Penthouse）。

## FITTINGS, FINISHES AND APPLIANCES

### 裝置、裝修物料及設備

#### Schedule of Mechanical & Electrical Provisions for Residential Property

#### 住宅單位機電裝置數量說明表

Location 位置	Provisions 裝置	Tower 2 第2座						
		G/F - 1/F 地下至1樓	G/F 地下	1/F 1樓	2/F - 3/F, 5/F - 6/F & 9/F 2樓至3樓、 5樓至6樓及 9樓	7/F & 8/F 7樓至8樓		10/F - 11/F 10樓至11樓
		Garden Duplex	• Garden Apartment	Flat B B單位	Flat A & B A及B單位	Flat A A單位	Flat B B單位	Spa Duplex A&B
Roof 天台	Lighting Point 燈位							11
	Fused Spur Unit 保險絲接線位							1
	Single Waterproof Socket Outlet 防水單位電插座							1
Air-Conditioner Platform (Next to Living Room / Dining Room) 空調機平台 (客廳 / 飯廳旁)	Switch for A/C Outdoor Unit 空調室外機開關			1	1	1	1	
Study Room 2 書房2	Twin Socket Outlet 雙位電插座							1
	Lighting Point 燈位							1
	Switch for A/C Outdoor Unit 空調室外機開關							1
Garden & Front Garden 花園	Lighting Point 燈位	10	13					
	Single Waterproof Socket Outlet 防水單位電插座	1	1					
	Motion Sensor 移動感測器	3	3					
	Video Door Phone 視像對講機	1	1					
Outdoor VRV Area 室外變頻中央空調系統空間	Lighting Point 燈位	—	—					1
	Switch for A/C Outdoor Unit 空調室外機開關	2	2					2
Flat Roof (Next to Living Room / Dining Room) 平台 (客廳 / 飯廳旁)	Lighting Point 燈位			1				

#### Notes:

- The symbol “—” as shown in the above table denotes “Not provided”.
- The symbol “/” as shown in the above table denotes “Not applicable”.
- “Terrace Apartment”, “Garden Apartment” and “Courtyard Penthouse” are names for marketing purposes only and will not appear in any Deed of Mutual Covenant, the Preliminary Agreement for Sale and Purchase, Agreement for Sale and Purchase, Assignment, or any other title deeds and documents relating to the Development. The names as appearing on the approved building plans are: Flat A on 1/F of Tower 1 for Terrace Apartment on 1/F of Tower 1; Flat B on G/F of Tower 2 for Garden Apartment on G/F of Tower 2; Flat B on G/F of Tower 3 for Garden Apartment on G/F of Tower 3; Flat A on G/F of Tower 7 for Garden Apartment on G/F of Tower 7; Penthouse on 11/F of Tower 7 for Courtyard Penthouse on 11/F of Tower 7; Flat B on G/F of Tower 8 for Garden Apartment on G/F of Tower 8; Penthouse on 11/F of Tower 8 for Courtyard Penthouse on 11/F of Tower 8.

#### 備註:

- 上表內之“—”代表「不提供」。
- 上表內之“/”代表「不適用」。
- 「Terrace Apartment」、「Garden Apartment」及「Courtyard Penthouse」僅為市場推廣之用的名稱，並不會於關於發展項目的任何公契、臨時買賣合約、買賣合約、轉讓契及契據出現。經批准的建築圖則上顯示的名稱為：第1座1樓A單位（即第1座1樓Terrace Apartment）；第2座地下B單位（即第2座地下Garden Apartment）；第3座地下B單位（即第3座地下Garden Apartment）；第7座地下A單位（即第7座地下Garden Apartment）；第7座11樓Penthouse（即第7座11樓Courtyard Penthouse）；第8座地下B單位（即第8座地下Garden Apartment）；第8座11樓Penthouse（即第8座11樓Courtyard Penthouse）。

# FITTINGS, FINISHES AND APPLIANCES

## 裝置、裝修物料及設備

### Schedule of Mechanical & Electrical Provisions for Residential Property

#### 住宅單位機電裝置數量說明表

Location 位置	Provisions 裝置	Tower 3 第3座						
		G/F - 1/F 地下至1樓	G/F 地下	1/F 1樓	2/F 2樓	3/F, 5/F - 10/F 3樓、5樓至10樓	11/F 11樓	
		Garden Duplex	• Garden Apartment	Flat B B單位	Flat A A單位	Flat B B單位	Flat A & B A及B單位	Sky Pool Penthouse
Private Lift Lobby 私人電梯大堂	Lighting Point 燈位			5	5	5	5	5
	Door Bell Push Button 門鈴按鈕			1	1	1	1	1
	Fused Spur Unit 保險絲接線位			1	1	1	1	1
Living Room & Dining Room 客廳及飯廳	Single Socket Outlet 單位電插座	3	1	1	1	1	1	3
	Twin Socket Outlet 雙位電插座	5	3	3	3	3	3	6
	Telephone Outlet 電話插座	2	2	2	2	2	2	2
	TV/ FM Outlet 電視 / 電台天線插座	2	2	2	2	2	2	2
	Window Contact 窗磁控感應器	1	—	—	—	—	—	—
	Door Contact 門磁控感應器	5	3	—	—	—	—	—
	Breakglass Sensor 玻璃碎裂感應器	3	1	—	—	—	—	—
	Lighting Point 燈位	13	7	4	4	4	4	11
	Lighting Switch 燈掣	9	7	7	7	7	7	9
	Fused Spur Unit for Motorized Curtain 電簾保險絲電源接線位	1	1	1	1	1	1	1
	Fused Spur Unit 保險絲電源接線位	2	—	—	—	—	—	1
	Switch for AC indoor Unit 空調室內機開關	3	2	2	2	2	2	4
	Switch for Steamer 蒸爐開關掣	1	—	—	—	—	—	1
	Switch for Oven 焗爐開關制	1	—	—	—	—	—	1
	Switch for Exhaust Fan 抽氣扇開關掣	2	2	2	2	2	2	2
	Security System Control Keypad 保安系統鍵盤控制面板	1	1	—	—	—	—	—
	Video Door phone 視像對講機	1	1	—	—	—	—	1
Door Phone 門口對講機	—	—	1	1	1	1	—	
Water Inlet / Outlet Connection Point for Washing Machine 洗衣機來 / 去水位接駁點	1	—	—	—	—	—	—	
Hallway 走廊/門廳	Single Socket Outlet 單位電插座	1						
	Twin Socket Outlet 雙位電插座	1						
	Telephone Outlet 電話插座	1						
	TV/ FM Outlet 電視 / 電台天線插座	1						
	Lighting Point 燈位	4						
	Lighting Switch 燈掣	3						
	Switch for AC indoor Unit 空調室內機開關	1						
Staircase 樓梯	Lighting Point 燈位	1					1	
Entrance Lobby 電梯大堂	Door Bell Push Button 門鈴按鈕	1	1					

#### Notes:

- The symbol “ — ” as shown in the above table denotes “Not provided”.
- The symbol “ / ” as shown in the above table denotes “Not applicable”.
- “Terrace Apartment”, “Garden Apartment” and “Courtyard Penthouse” are names for marketing purposes only and will not appear in any Deed of Mutual Covenant, the Preliminary Agreement for Sale and Purchase, Agreement for Sale and Purchase, Assignment, or any other title deeds and documents relating to the Development. The names as appearing on the approved building plans are: Flat A on 1/F of Tower 1 for Terrace Apartment on 1/F of Tower 1; Flat B on G/F of Tower 2 for Garden Apartment on G/F of Tower 2; Flat B on G/F of Tower 3 for Garden Apartment on G/F of Tower 3; Flat A on G/F of Tower 7 for Garden Apartment on G/F of Tower 7; Penthouse on 11/F of Tower 7 for Courtyard Penthouse on 11/F of Tower 7; Flat B on G/F of Tower 8 for Garden Apartment on G/F of Tower 8; Penthouse on 11/F of Tower 8 for Courtyard Penthouse on 11/F of Tower 8.

#### 備註:

- 上表內之「—」代表「不提供」。
- 上表內之「/」代表「不適用」。
- 「Terrace Apartment」、「Garden Apartment」及「Courtyard Penthouse」僅為市場推廣之用的名稱，並不會於關於發展項目的任何公契、臨時買賣合約、買賣合約、轉讓契及契據出現。經批准的建築圖則上顯示的名稱為：第1座1樓A單位（即第1座1樓Terrace Apartment）；第2座地下B單位（即第2座地下Garden Apartment）；第3座地下B單位（即第3座地下Garden Apartment）；第7座地下A單位（即第7座地下Garden Apartment）；第7座11樓Penthouse（即第7座11樓Courtyard Penthouse）；第8座地下B單位（即第8座地下Garden Apartment）；第8座11樓Penthouse（即第8座11樓Courtyard Penthouse）。

# FITTINGS, FINISHES AND APPLIANCES

## 裝置、裝修物料及設備

### Schedule of Mechanical & Electrical Provisions for Residential Property

#### 住宅單位機電裝置數量說明表

Location 位置	Provisions 裝置	Tower 3 第3座						
		G/F - 1/F 地下至1樓	G/F 地下	1/ F 1樓	2/F 2樓		3/F, 5/F - 10/F 3樓、5樓至10樓	11/F 11樓
		Garden Duplex	• Garden Apartment	Flat B B單位	Flat A A單位	Flat B B單位	Flat A & B A及B單位	Sky Pool Penthouse
Master Bedroom 主人睡房	Twin Socket Outlet 雙位電插座	3	2	2	2	2	2	2
	Telephone Outlet 電話插座	2	2	2	2	2	2	2
	TV/ FM Outlet 電視 / 電台天線插座	2	2	2	2	2	2	2
	Panic Alarm Button 警鐘按鈕	1	1	1	1	1	1	1
	Lighting Point 燈位	3	1	1	1	1	1	2
	Lighting Switch 燈掣	4	3	2	2	2	2	2
	Fused Spur Unit for Motorized Curtain 電簾保險絲電源接線位	1	1	1	1	1	1	1
	Switch for AC indoor Unit 空調室內機開關	2	1	1	1	1	1	2
	Door Contact 門磁控感應器	—	1	—	—	—	—	—
	Window Contact 窗磁控感應器	—	1	—	—	—	—	—
	Breakglass Sensor 玻璃碎裂感應器	—	2	—	—	—	—	—
Ensuite 1 套房 1	Twin Socket Outlet 雙位電插座	2	2	2	2	2	2	2
	Telephone Outlet 電話插座	1	1	1	1	1	1	1
	TV/ FM Outlet 電視 / 電台天線插座	1	1	1	1	1	1	1
	Lighting Point 燈位	1	1	1	1	1	1	1
	Lighting Switch 燈掣	2	3	3	3	3	3	2
	Switch for AC indoor Unit 空調室內機開關	1	1	1	1	1	1	1
	Switch for Exhaust Fan 抽氣扇開關掣	1	1	1	1	1	1	1
	Door Contact 門磁控感應器	—	1	—	—	—	—	—
	Window Contact 窗磁控感應器	—	—	—	—	—	—	—
Breakglass Sensor 玻璃碎裂感應器	—	1	—	—	—	—	—	
Ensuite 2 套房 2	Twin Socket Outlet 雙位電插座	2	2	2	2	2	2	2
	Telephone Outlet 電話插座	1	1	1	1	1	1	1
	TV/ FM Outlet 電視 / 電台天線插座	1	1	1	1	1	1	1
	Lighting Point 燈位	1	1	1	1	1	1	1
	Lighting Switch 燈掣	2	2	2	2	2	2	2
	Switch for AC indoor Unit 空調室內機開關	1	1	1	1	1	1	1
	Switch for Exhaust Fan 抽氣扇開關掣	1	1	1	1	1	1	1
	Door Contact 門磁控感應器	—	1	—	—	—	—	—
	Window Contact 窗磁控感應器	—	2	—	—	—	—	—
Breakglass Sensor 玻璃碎裂感應器	—	2	—	—	—	—	—	

#### Notes:

- The symbol “ — ” as shown in the above table denotes “Not provided”.
- The symbol “ / ” as shown in the above table denotes “Not applicable”.
- “Terrace Apartment”, “Garden Apartment” and “Courtyard Penthouse” are names for marketing purposes only and will not appear in any Deed of Mutual Covenant, the Preliminary Agreement for Sale and Purchase, Agreement for Sale and Purchase, Assignment, or any other title deeds and documents relating to the Development. The names as appearing on the approved building plans are: Flat A on 1/F of Tower 1 for Terrace Apartment on 1/F of Tower 1; Flat B on G/F of Tower 2 for Garden Apartment on G/F of Tower 2; Flat B on G/F of Tower 3 for Garden Apartment on G/F of Tower 3; Flat A on G/F of Tower 7 for Garden Apartment on G/F of Tower 7; Penthouse on 11/F of Tower 7 for Courtyard Penthouse on 11/F of Tower 7; Flat B on G/F of Tower 8 for Garden Apartment on G/F of Tower 8; Penthouse on 11/F of Tower 8 for Courtyard Penthouse on 11/F of Tower 8.

#### 備註:

- 上表內之「—」代表「不提供」。
- 上表內之「/」代表「不適用」。
- 「Terrace Apartment」、「Garden Apartment」及「Courtyard Penthouse」僅為市場推廣之用的名稱，並不會於關於發展項目的任何公契、臨時買賣合約、買賣合約、轉讓契及契據出現。經批准的建築圖則上顯示的名稱為：第1座1樓A單位（即第1座1樓Terrace Apartment）；第2座地下B單位（即第2座地下Garden Apartment）；第3座地下B單位（即第3座地下Garden Apartment）；第7座地下A單位（即第7座地下Garden Apartment）；第7座11樓Penthouse（即第7座11樓Courtyard Penthouse）；第8座地下B單位（即第8座地下Garden Apartment）；第8座11樓Penthouse（即第8座11樓Courtyard Penthouse）。



# FITTINGS, FINISHES AND APPLIANCES

## 裝置、裝修物料及設備

### Schedule of Mechanical & Electrical Provisions for Residential Property

#### 住宅單位機電裝置數量說明表

Location 位置	Provisions 裝置	Tower 3 第3座						
		G/F - 1/F 地下至1樓	G/F 地下	1/F 1樓	2/F 2樓	3/F, 5/F - 10/F 3樓、5樓至10樓	11/F 11樓	
		Garden Duplex	• Garden Apartment	Flat B B單位	Flat A A單位	Flat B B單位	Flat A & B A及B單位	Sky Pool Penthouse
Ensuite 3 套房3	Twin Socket Outlet 雙位電插座	2	2	2	2	2	2	2
	Telephone Outlet 電話插座	1	1	1	1	1	1	1
	TV/ FM Outlet 電視 / 電台天線插座	1	1	1	1	1	1	1
	Lighting Point 燈位	1	1	1	1	1	1	1
	Lighting Switch 燈掣	2	2	2	2	2	2	3
	Switch for AC indoor Unit 空調室內機開關	1	1	1	1	1	1	1
	Switch for Exhaust Fan 抽氣扇開關掣	1	1	1	1	1	1	1
	Door Contact 門磁控感應器	—	1	—	—	—	—	—
	Window Contact 窗磁控感應器	—	1	—	—	—	—	—
	Breakglass Sensor 玻璃碎裂感應器	—	1	—	—	—	—	—
Kitchen 廚房	Single Socket Outlet 單位電插座	2	2	5	5	5	5	2
	Twin Socket Outlet 雙位電插座	2	5	4	4	4	4	3
	Lighting Point 燈位	4	8	10	10	10	10	4
	Lighting Switch 燈掣	—	—	—	—	—	—	—
	Switch for Oven 焗爐開關制	—	1	1	1	1	1	—
	Switch for Steamer 蒸爐開關掣	—	1	—	—	—	—	—
	Switch for Induction Cooker 電磁爐開關制	1	1	1	1	1	1	1
	Fused Spur Unit 保險絲電源接線位	4	3	6	6	6	6	6
	Switch for AC indoor Unit 空調室內機開關	1	1	1	1	1	1	1
	Gas Water Heater Remote Controller 煤氣熱水爐恆溫掣	1	1	1	1	1	1	1
	Window Contact 窗磁控感應器	1	1	—	—	—	—	—
	Door Bell 門鈴	1	1	1	1	1	1	1
	Door Contact 門磁控感應器	1	1	—	—	—	—	—
	Breakglass Sensor 玻璃碎裂感應器	1	1	—	—	—	—	—
	Siren Bell with Strobe Light 閃燈警報器	1	1	—	—	—	—	—
	Town Gas Connection Point 煤氣接駁點	1	1	1	1	1	1	1
	Water Inlet / Outlet Connection Point for Dish Washer 洗碗機來 / 去水位接駁點	1	1	—	—	—	—	1
Water Inlet / Outlet Connection Point for Washing Machine 洗衣機來 / 去水位接駁點	—	1	1	1	1	1	1	
Store Room 2 儲物室2	Twin Socket Outlet 雙位電插座	1						1
	Lighting Point 燈位	1						1
	Lighting Switch 燈掣	1						2

#### Notes:

- The symbol “ — ” as shown in the above table denotes “Not provided”.
- The symbol “ / ” as shown in the above table denotes “Not applicable”.
- “Terrace Apartment”, “Garden Apartment” and “Courtyard Penthouse” are names for marketing purposes only and will not appear in any Deed of Mutual Covenant, the Preliminary Agreement for Sale and Purchase, Agreement for Sale and Purchase, Assignment, or any other title deeds and documents relating to the Development. The names as appearing on the approved building plans are: Flat A on 1/F of Tower 1 for Terrace Apartment on 1/F of Tower 1; Flat B on G/F of Tower 2 for Garden Apartment on G/F of Tower 2; Flat B on G/F of Tower 3 for Garden Apartment on G/F of Tower 3; Flat A on G/F of Tower 7 for Garden Apartment on G/F of Tower 7; Penthouse on 11/F of Tower 7 for Courtyard Penthouse on 11/F of Tower 7; Flat B on G/F of Tower 8 for Garden Apartment on G/F of Tower 8; Penthouse on 11/F of Tower 8 for Courtyard Penthouse on 11/F of Tower 8.

#### 備註:

- 上表內之「—」代表「不提供」。
- 上表內之「/」代表「不適用」。
- 「Terrace Apartment」、「Garden Apartment」及「Courtyard Penthouse」僅為市場推廣之用的名稱，並不會於關於發展項目的任何公契、臨時買賣合約、買賣合約、轉讓契及契據出現。經批准的建築圖則上顯示的名稱為：第1座1樓A單位（即第1座1樓Terrace Apartment）；第2座地下B單位（即第2座地下Garden Apartment）；第3座地下B單位（即第3座地下Garden Apartment）；第7座地下A單位（即第7座地下Garden Apartment）；第7座11樓Penthouse（即第7座11樓Courtyard Penthouse）；第8座地下B單位（即第8座地下Garden Apartment）；第8座11樓Penthouse（即第8座11樓Courtyard Penthouse）。



# FITTINGS, FINISHES AND APPLIANCES

## 裝置、裝修物料及設備

### Schedule of Mechanical & Electrical Provisions for Residential Property

#### 住宅單位機電裝置數量說明表

Location 位置	Provisions 裝置	Tower 3 第3座						
		G/F - 1/F 地下至1樓	G/F 地下	1/F 1樓	2/F 2樓	3/F, 5/F - 10/F 3樓、5樓至10樓	11/F 11樓	
		Garden Duplex	• Garden Apartment	Flat B B單位	Flat A A單位	Flat B B單位	Flat A & B A及B單位	Sky Pool Penthouse
Store Room 3 儲物室3	Single Socket Outlet 單位電插座	—	/	/	/	/	/	/
	Twin Socket Outlet 雙位電插座	—	/	/	/	/	/	/
	Lighting Point 燈位	1	/	/	/	/	/	/
	Lighting Switch 燈掣	1	/	/	/	/	/	/
Master Bathroom 主人浴室	Single Socket Outlet 單位電插座	1	1	1	1	1	1	2
	Twin Socket Outlet 雙位電插座	1	1	1	1	1	1	1
	TV/ FM Outlet 電視 / 電台天線插座	1	1	1	1	1	1	1
	Lighting Point 燈位	11	7	6	6	6	6	10
	Gas Water Heater Remote Controller 煤氣熱水爐恆溫掣	1	1	1	1	1	1	1
	Switch for Thermal Ventilator 浴室寶開關	1	1	1	1	1	1	1
	Fused Spur Unit for Motorized Curtain 電簾保險絲電源接線位	1	1	1	1	1	1	1
	Fused Spur Unit 保險絲電源接線位	3	3	3	3	3	3	3
	Breakglass Sensor 玻璃碎裂感應器	—	1	—	—	—	—	—
	Window Contact 窗磁控感應器	—	3	—	—	—	—	—
Bathroom 1 浴室1	Twin Socket Outlet 雙位電插座	1	1	1	1	1	1	1
	Lighting Point 燈位	3	3	3	3	3	3	3
	Gas Water Heater Remote Controller 煤氣熱水爐恆溫掣	1	1	1	1	1	1	1
	Window Contact 窗磁控感應器	—	—	2	2	2	2	2
Bathroom 2 浴室2	Twin Socket Outlet 雙位電插座	1	1	1	1	1	1	1
	Lighting Point 燈位	3	3	3	3	3	3	3
	Gas Water Heater Remote Controller 煤氣熱水爐恆溫掣	1	1	1	1	1	1	1
	Fused Spur Unit 保險絲電源接線位	2	2	2	2	2	2	2
	Breakglass Sensor 玻璃碎裂感應器	—	1	—	—	—	—	—
	Window Contact 窗磁控感應器	—	1	—	—	—	—	—

#### Notes:

- The symbol “ — ” as shown in the above table denotes “Not provided”.
- The symbol “ / ” as shown in the above table denotes “Not applicable”.
- “Terrace Apartment”, “Garden Apartment” and “Courtyard Penthouse” are names for marketing purposes only and will not appear in any Deed of Mutual Covenant, the Preliminary Agreement for Sale and Purchase, Agreement for Sale and Purchase, Assignment, or any other title deeds and documents relating to the Development. The names as appearing on the approved building plans are: Flat A on 1/F of Tower 1 for Terrace Apartment on 1/F of Tower 1; Flat B on G/F of Tower 2 for Garden Apartment on G/F of Tower 2; Flat B on G/F of Tower 3 for Garden Apartment on G/F of Tower 3; Flat A on G/F of Tower 7 for Garden Apartment on G/F of Tower 7; Penthouse on 11/F of Tower 7 for Courtyard Penthouse on 11/F of Tower 7; Flat B on G/F of Tower 8 for Garden Apartment on G/F of Tower 8; Penthouse on 11/F of Tower 8 for Courtyard Penthouse on 11/F of Tower 8.

#### 備註:

- 上表內之「—」代表「不提供」。
- 上表內之「/」代表「不適用」。
- 「Terrace Apartment」、「Garden Apartment」及「Courtyard Penthouse」僅為市場推廣之用的名稱，並不會於關於發展項目的任何公契、臨時買賣合約、買賣合約、轉讓契及契據出現。經批准的建築圖則上顯示的名稱為：第1座1樓A單位（即第1座1樓Terrace Apartment）；第2座地下B單位（即第2座地下Garden Apartment）；第3座地下B單位（即第3座地下Garden Apartment）；第7座地下A單位（即第7座地下Garden Apartment）；第7座11樓Penthouse（即第7座11樓Courtyard Penthouse）；第8座地下B單位（即第8座地下Garden Apartment）；第8座11樓Penthouse（即第8座11樓Courtyard Penthouse）。

# FITTINGS, FINISHES AND APPLIANCES

## 裝置、裝修物料及設備

### Schedule of Mechanical & Electrical Provisions for Residential Property

#### 住宅單位機電裝置數量說明表

Location 位置	Provisions 裝置	Tower 3 第3座						
		G/F - 1/F 地下至1樓	G/F 地下	1/F 1樓	2/F 2樓	3/F, 5/F - 10/F 3樓、5樓至10樓	11/F 11樓	
		Garden Duplex	• Garden Apartment	Flat B B單位	Flat A A單位	Flat B B單位	Flat A & B A及B單位	Sky Pool Penthouse
Bathroom 3 浴室3	Twin Socket Outlet 雙位電插座	1	1	1	1	1	1	1
	Lighting Point 燈位	3	3	3	3	3	3	3
	Gas Water Heater Remote Controller 煤氣熱水爐恆溫掣	1	1	1	1	1	1	1
	Fused Spur Unit 保險絲電源接線位	2	2	2	2	2	2	2
Powder Room 客廳洗手間	Lighting Point 燈位	2	2	2	2	2	2	2
	Fused Spur Unit 保險絲電源接線位	2	2	2	2	2	2	2
Store Room 儲物室	Single Socket Outlet 單位電插座		—					
	Lighting Point 燈位		1					
	Lighting Switch 燈掣		1					
Store Room 1 儲物室1	Lighting Point 燈位							1
	Lighting Switch 燈掣							1
Store Room 1 with Lavatory 附有洗手間之工作間1	Breakglass Sensor 玻璃碎裂感應器	2						
	Window Contact 窗磁控感應器	1						
	Twin Socket Outlet 雙位電插座	1						
	Lighting Point 燈位	2						
	Lighting Switch 燈掣	2						
	On/Off Switch for Exhaust Fan 抽氣扇開關掣	1						
	Fused Spur Unit 保險絲接線位	3						
	Switch for AC indoor Unit 空調室內機開關	1						
	Air-conditioner Central Controller 冷氣中央控制器	1						
	Miniature Circuit Breaker Board 微型斷路箱	1						
	Security System Control Panel 保安系統控制箱	1						
Tower Gas Meter 煤氣計量錶	1							

#### Notes:

- The symbol “ — ” as shown in the above table denotes “Not provided”.
- The symbol “ / ” as shown in the above table denotes “Not applicable”.
- “Terrace Apartment”, “Garden Apartment” and “Courtyard Penthouse” are names for marketing purposes only and will not appear in any Deed of Mutual Covenant, the Preliminary Agreement for Sale and Purchase, Agreement for Sale and Purchase, Assignment, or any other title deeds and documents relating to the Development. The names as appearing on the approved building plans are: Flat A on 1/F of Tower 1 for Terrace Apartment on 1/F of Tower 1; Flat B on G/F of Tower 2 for Garden Apartment on G/F of Tower 2; Flat B on G/F of Tower 3 for Garden Apartment on G/F of Tower 3; Flat A on G/F of Tower 7 for Garden Apartment on G/F of Tower 7; Penthouse on 11/F of Tower 7 for Courtyard Penthouse on 11/F of Tower 7; Flat B on G/F of Tower 8 for Garden Apartment on G/F of Tower 8; Penthouse on 11/F of Tower 8 for Courtyard Penthouse on 11/F of Tower 8.

#### 備註:

- 上表內之「—」代表「不提供」。
- 上表內之「/」代表「不適用」。
- 「Terrace Apartment」、「Garden Apartment」及「Courtyard Penthouse」僅為市場推廣之用的名稱，並不會於關於發展項目的任何公契、臨時買賣合約、買賣合約、轉讓契及契據出現。經批准的建築圖則上顯示的名稱為：第1座1樓A單位（即第1座1樓Terrace Apartment）；第2座地下B單位（即第2座地下Garden Apartment）；第3座地下B單位（即第3座地下Garden Apartment）；第7座地下A單位（即第7座地下Garden Apartment）；第7座11樓Penthouse（即第7座11樓Courtyard Penthouse）；第8座地下B單位（即第8座地下Garden Apartment）；第8座11樓Penthouse（即第8座11樓Courtyard Penthouse）。

# FITTINGS, FINISHES AND APPLIANCES

## 裝置、裝修物料及設備

### Schedule of Mechanical & Electrical Provisions for Residential Property

#### 住宅單位機電裝置數量說明表

Location 位置	Provisions 裝置	Tower 3 第3座						
		G/F - 1/F 地下至1樓	G/F 地下	1/ F 1樓	2/F 2樓	3/F, 5/F - 10/F 3樓、5樓至10樓	11/F 11樓	
		Garden Duplex	• Garden Apartment	Flat B B單位	Flat A A單位	Flat B B單位	Flat A & B A及B單位	Sky Pool Penthouse
Utility Room with Lavatory 附有洗手間之工作間	Twin Socket Outlet 雙位電插座	/	1	1	1	1	1	1
	Lighting Point 燈位	/	2	2	2	2	2	2
	Lighting Switch 燈掣	/	2	2	2	2	2	2
	Switch for Exhaust Fan 抽氣扇開關掣	/	1	1	1	1	1	1
	Fused Spur Unit 保險絲接線位	/	3	3	3	3	3	3
	Switch for AC indoor Unit 空調室內機開關	/	1	1	1	1	1	1
	Air-conditioner Central Controller 冷氣中央控制器	/	1	—	—	—	—	1
	Miniature Circuit Breaker Board 微型斷路箱	/	1	1	1	1	1	1
	Tower Gas Meter 煤氣計量錶	/	1	1	1	1	1	1
	Window Contact 窗磁控感應器	/	1	—	—	—	—	—
	Breakglass Sensor 玻璃碎裂感應器	/	1	—	—	—	—	—
Security System Control Panel 保安系統控制箱	/	1	—	—	—	—	—	
Utility Platform 工作平台	Lighting Point 燈位	/	/	/	1	1	1	1
Air-Conditioner Platform (Utility Room) 空調機平台 (工作間)	Switch for A/C Outdoor Unit 空調室外機開關	/	/	5	5	5	5	/
Balcony 露台	Lighting Point 燈位	1	/	/	1	1	1	1
Air-Conditioner Platform (Lavatory) 空調機平台 (洗手間)	Switch for AC indoor Unit 空調室內機開關	/	/	/	1	1	1	/
Flat Roof 平台	Lighting Point 燈位	/	/	/	/	/	/	8
	Single Waterproof Socket Outlet 防水單位電插座	/	/	/	/	/	/	1
	Switch for A/C Outdoor Unit 空調室外機開關	/	/	/	/	/	/	—
	Switch for Filtration Plant 泳池過濾系統開關	/	/	/	/	/	/	1
	Underwater Lighting in Swimming Pool 泳池水下燈	/	/	/	/	/	/	8
	Water Inlet Connection Point for Swimming Pool Filtration Cabinet 游泳池過濾櫃來水位接駁點	/	/	/	/	/	/	1
	Water Outlet Connection Point for Swimming Pool Filtration Cabinet 游泳池過濾櫃去水位接駁點	/	/	/	/	/	/	2

Notes:

- The symbol “ — ” as shown in the above table denotes “Not provided”.
- The symbol “ / ” as shown in the above table denotes “Not applicable”.
- “Terrace Apartment”, “Garden Apartment” and “Courtyard Penthouse” are names for marketing purposes only and will not appear in any Deed of Mutual Covenant, the Preliminary Agreement for Sale and Purchase, Agreement for Sale and Purchase, Assignment, or any other title deeds and documents relating to the Development. The names as appearing on the approved building plans are: Flat A on 1/F of Tower 1 for Terrace Apartment on 1/F of Tower 1; Flat B on G/F of Tower 2 for Garden Apartment on G/F of Tower 2; Flat B on G/F of Tower 3 for Garden Apartment on G/F of Tower 3; Flat A on G/F of Tower 7 for Garden Apartment on G/F of Tower 7; Penthouse on 11/F of Tower 7 for Courtyard Penthouse on 11/F of Tower 7; Flat B on G/F of Tower 8 for Garden Apartment on G/F of Tower 8; Penthouse on 11/F of Tower 8 for Courtyard Penthouse on 11/F of Tower 8.

備註:

- 上表內之「—」代表「不提供」。
- 上表內之「/」代表「不適用」。
- 「Terrace Apartment」、「Garden Apartment」及「Courtyard Penthouse」僅為市場推廣之用的名稱，並不會於關於發展項目的任何公契、臨時買賣合約、買賣合約、轉讓契及契據出現。經批准的建築圖則上顯示的名稱為：第1座1樓A單位（即第1座1樓Terrace Apartment）；第2座地下B單位（即第2座地下Garden Apartment）；第3座地下B單位（即第3座地下Garden Apartment）；第7座地下A單位（即第7座地下Garden Apartment）；第7座11樓Penthouse（即第7座11樓Courtyard Penthouse）；第8座地下B單位（即第8座地下Garden Apartment）；第8座11樓Penthouse（即第8座11樓Courtyard Penthouse）。

## FITTINGS, FINISHES AND APPLIANCES

### 裝置、裝修物料及設備

#### Schedule of Mechanical & Electrical Provisions for Residential Property

#### 住宅單位機電裝置數量說明表

Location 位置	Provisions 裝置	Tower 3 第3座					
		G/F - 1/F 地下至1樓	G/F 地下	1/F 1樓	2/F 2樓	3/F, 5/F - 10/F 3樓、5樓至10樓	11/F 11樓
		Garden Duplex	• Garden Apartment	Flat B B單位	Flat A A單位	Flat B B單位	Flat A & B A及B單位
Roof 天台	Lighting Point 燈位						12
	Fused Spar Unit 保險絲接線位						1
	Single Waterproof Socket Outlet 防水單位電插座						1
Flat Roof for Ensuite 1 & 3 套房1及3平台	Lighting Point 燈位			1			
	Switch for A/C Outdoor Unit 空調室外機開關			1			
Flat Roof (Living Room / Dining Room) 平台 (客廳 / 飯廳)	Lighting Point 燈位			1			
Garden 花園	Lighting Point 燈位	10	12				
	Single Waterproof Socket Outlet 防水單位電插座	2	1				
	Motion Sensor 活動感應器	3	3				
	Video Door Phone 視像對講機	1	1				
Outdoor VRV Area 室外變頻中央空調系統空間	Lighting Point 燈位	—	—				1
	Switch for A/C Outdoor Unit 空調室外機開關	2	2				2
Flat Roof (Master Bedroom) 平台 (主人睡房)	Lighting Point 燈位						2

#### Notes:

- The symbol “—” as shown in the above table denotes “Not provided”.
- The symbol “/” as shown in the above table denotes “Not applicable”.
- “Terrace Apartment”, “Garden Apartment” and “Courtyard Penthouse” are names for marketing purposes only and will not appear in any Deed of Mutual Covenant, the Preliminary Agreement for Sale and Purchase, Agreement for Sale and Purchase, Assignment, or any other title deeds and documents relating to the Development. The names as appearing on the approved building plans are: Flat A on 1/F of Tower 1 for Terrace Apartment on 1/F of Tower 1; Flat B on G/F of Tower 2 for Garden Apartment on G/F of Tower 2; Flat B on G/F of Tower 3 for Garden Apartment on G/F of Tower 3; Flat A on G/F of Tower 7 for Garden Apartment on G/F of Tower 7; Penthouse on 11/F of Tower 7 for Courtyard Penthouse on 11/F of Tower 7; Flat B on G/F of Tower 8 for Garden Apartment on G/F of Tower 8; Penthouse on 11/F of Tower 8 for Courtyard Penthouse on 11/F of Tower 8.

#### 備註:

- 上表內之“—”代表「不提供」。
- 上表內之“/”代表「不適用」。
- 「Terrace Apartment」、「Garden Apartment」及「Courtyard Penthouse」僅為市場推廣之用的名稱，並不會於關於發展項目的任何公契、臨時買賣合約、買賣合約、轉讓契及契據出現。經批准的建築圖則上顯示的名稱為：第1座1樓A單位（即第1座1樓Terrace Apartment）；第2座地下B單位（即第2座地下Garden Apartment）；第3座地下B單位（即第3座地下Garden Apartment）；第7座地下A單位（即第7座地下Garden Apartment）；第7座11樓Penthouse（即第7座11樓Courtyard Penthouse）；第8座地下B單位（即第8座地下Garden Apartment）；第8座11樓Penthouse（即第8座11樓Courtyard Penthouse）。



# FITTINGS, FINISHES AND APPLIANCES

## 裝置、裝修物料及設備

### Schedule of Mechanical & Electrical Provisions for Residential Property

#### 住宅單位機電裝置數量說明表

Location 位置	Provisions 裝置	Tower 5 第5座				Tower 6 第6座			
		1/F 1樓		2/F - 3/F, 5/F - 10/F 2樓至3樓、5樓 至10樓	11/F 11樓	1/F 1樓		2/F - 3/F, 5/F - 10/F 2樓至3樓、5樓 至10樓	11/F 11樓
		Flat A A單位	Flat B B單位	Flat A & B A及B單位	Sky Pool Penthouse	Flat A A單位	Flat B B單位	Flat A & B A及B單位	Sky Pool Penthouse
Private Lift Lobby 私人電梯大堂	Lighting Point 燈位	5	5	5	5	5	5	5	5
	Fused Spur Unit 保險絲接線位	1	1	1	1	1	1	1	1
	Door Bell Push Button 門鈴按鈕	1	1	1	1	1	1	1	1
Living Room & Dining Room 客廳及飯廳	Single Socket Outlet 單位電插座	1	1	1	3	1	1	1	3
	Twin Socket Outlet 雙位電插座	3	3	3	4	3	3	3	4
	Telephone Outlet 電話插座	2	2	2	2	2	2	2	2
	TV/ FM Outlet 電視 / 電台天線插座	2	2	2	2	2	2	2	2
	Lighting Point 燈位	4	4	4	15	4	4	4	15
	Lighting Switch 燈掣	5	6	6	8	6	5	6	8
	Fused Spur Unit for Motorized Curtain 電簾保險絲電源接線位	1	1	1	2	1	1	1	2
	Fused Spur Unit 保險絲接線位	—	—	—	1	—	—	—	1
	Switch for AC indoor Unit 空調室內機開關	2	2	2	4	2	2	2	4
	Switch for Oven 焗爐開關制	—	—	—	1	—	—	—	1
	Switch for Steamer 蒸爐開關制	—	—	—	1	—	—	—	1
	On/Off Switch for Exhaust Fan 抽氣扇開關掣	2	2	2	2	2	2	2	2
	Video Door phone 視像對講機	—	—	—	1	—	—	—	1
	Door Phone 門口對講機	1	1	1	—	1	1	1	—
Master Bedroom 主人睡房	Twin Socket Outlet 雙位電插座	2	2	2	2	2	2	2	2
	Telephone Outlet 電話插座	2	2	2	2	2	2	2	2
	TV/ FM Outlet 電視 / 電台天線插座	2	2	2	2	2	2	2	2
	Panic Alarm Button 警鐘按鈕	1	1	1	1	1	1	1	1
	Lighting Point 燈位	1	1	1	3	1	1	1	3
	Lighting Switch 燈掣	3	2	2	2	2	3	2	2
	Fused Spur Unit for Motorized Curtain 電動窗簾保險絲接線位	1	1	1	1	1	1	1	1
	Switch for AC indoor Unit 空調室內機開關	1	1	1	1	1	1	1	1
Bedroom 1 睡房 1	Twin Socket Outlet 雙位電插座	2	2	2	/	2	2	2	/
	Telephone Outlet 電話插座	1	1	1	/	1	1	1	/
	TV/ FM Outlet 電視 / 電台天線插座	1	1	1	/	1	1	1	/
	Lighting Point 燈位	1	1	1	/	1	1	1	/
	Lighting Switch 燈掣	1	1	1	/	1	1	1	/
	Switch for AC indoor Unit 空調室內機開關	1	1	1	/	1	1	1	/

Notes:

- The symbol “ — ” as shown in the above table denotes “Not provided”.
- The symbol “ / ” as shown in the above table denotes “Not applicable”.
- “Terrace Apartment”, “Garden Apartment” and “Courtyard Penthouse” are names for marketing purposes only and will not appear in any Deed of Mutual Covenant, the Preliminary Agreement for Sale and Purchase, Agreement for Sale and Purchase, Assignment, or any other title deeds and documents relating to the Development. The names as appearing on the approved building plans are: Flat A on 1/F of Tower 1 for Terrace Apartment on 1/F of Tower 1; Flat B on G/F of Tower 2 for Garden Apartment on G/F of Tower 2; Flat B on G/F of Tower 3 for Garden Apartment on G/F of Tower 3; Flat A on G/F of Tower 7 for Garden Apartment on G/F of Tower 7; Penthouse on 11/F of Tower 7 for Courtyard Penthouse on 11/F of Tower 7; Flat B on G/F of Tower 8 for Garden Apartment on G/F of Tower 8; Penthouse on 11/F of Tower 8 for Courtyard Penthouse on 11/F of Tower 8.

備註:

- 上表內之「—」代表「不提供」。
- 上表內之「/」代表「不適用」。
- 「Terrace Apartment」、「Garden Apartment」及「Courtyard Penthouse」僅為市場推廣之用的名稱，並不會於關於發展項目的任何公契、臨時買賣合約、買賣合約、轉讓契及契據出現。經批准的建築圖則上顯示的名稱為：第1座1樓A單位（即第1座1樓Terrace Apartment）；第2座地下B單位（即第2座地下Garden Apartment）；第3座地下B單位（即第3座地下Garden Apartment）；第7座地下A單位（即第7座地下Garden Apartment）；第7座11樓Penthouse（即第7座11樓Courtyard Penthouse）；第8座地下B單位（即第8座地下Garden Apartment）；第8座11樓Penthouse（即第8座11樓Courtyard Penthouse）。



# FITTINGS, FINISHES AND APPLIANCES

## 裝置、裝修物料及設備

### Schedule of Mechanical & Electrical Provisions for Residential Property

#### 住宅單位機電裝置數量說明表

Location 位置	Provisions 裝置	Tower 5 第5座				Tower 6 第6座			
		1/F 1樓		2/F - 3/F, 5/F - 10/F 2樓至3樓、5樓 至10樓	11/F 11樓	1/F 1樓		2/F - 3/F, 5/F - 10/F 2樓至3樓、5樓 至10樓	11/F 11樓
		Flat A A單位	Flat B B單位	Flat A & B A及B單位	Sky Pool Penthouse	Flat A A單位	Flat B B單位	Flat A & B A及B單位	Sky Pool Penthouse
Bedroom 2 睡房 2	Twin Socket Outlet 雙位電插座	2	2	2		2	2	2	
	Telephone Outlet 電話插座	1	1	1		1	1	1	
	TV/ FM Outlet 電視 / 電台天線插座	1	1	1		1	1	1	
	Lighting Point 燈位	1	1	1		1	1	1	
	Lighting Switch 燈掣	1	1	1		1	1	1	
	Switch for AC indoor Unit 空調室內機開關	1	1	1		1	1	1	
Ensuite 套房	Twin Socket Outlet 雙位電插座	2	2	2		2	2	2	
	Telephone Outlet 電話插座	1	1	1		1	1	1	
	TV/ FM Outlet 電視 / 電台天線插座	1	1	1		1	1	1	
	Lighting Point 燈位	1	1	1		1	1	1	
	Lighting Switch 燈掣	3	3	3		3	3	3	
	Switch for AC indoor Unit 空調室內機開關	1	1	1		1	1	1	
	On/Off Switch for Exhaust Fan 抽氣扇開關掣	1	1	1		1	1	1	
Ensuite 1 套房 1	Twin Socket Outlet 雙位電插座				2				2
	Telephone Outlet 電話插座				1				1
	TV/ FM Outlet 電視 / 電台天線插座				1				1
	Lighting Point 燈位				1				1
	Lighting Switch 燈掣				2				2
	Switch for AC indoor Unit 空調室內機開關				1				1
	Switch for Exhaust Fan 抽氣扇開關掣				1				1
Ensuite 2 套房 2	Twin Socket Outlet 雙位電插座				2				2
	Telephone Outlet 電話插座				1				1
	TV/ FM Outlet 電視 / 電台天線插座				1				1
	Lighting Point 燈位				1				1
	Lighting Switch 燈掣				3				3
	Switch for AC indoor Unit 空調室內機開關				1				1
	On/Off Switch for Exhaust Fan 抽氣扇開關掣				1				1

#### Notes:

- The symbol “—” as shown in the above table denotes “Not provided”.
- The symbol “/” as shown in the above table denotes “Not applicable”.
- “Terrace Apartment”, “Garden Apartment” and “Courtyard Penthouse” are names for marketing purposes only and will not appear in any Deed of Mutual Covenant, the Preliminary Agreement for Sale and Purchase, Agreement for Sale and Purchase, Assignment, or any other title deeds and documents relating to the Development. The names as appearing on the approved building plans are: Flat A on 1/F of Tower 1 for Terrace Apartment on 1/F of Tower 1; Flat B on G/F of Tower 2 for Garden Apartment on G/F of Tower 2; Flat B on G/F of Tower 3 for Garden Apartment on G/F of Tower 3; Flat A on G/F of Tower 7 for Garden Apartment on G/F of Tower 7; Penthouse on 11/F of Tower 7 for Courtyard Penthouse on 11/F of Tower 7; Flat B on G/F of Tower 8 for Garden Apartment on G/F of Tower 8; Penthouse on 11/F of Tower 8 for Courtyard Penthouse on 11/F of Tower 8.

#### 備註:

- 上表內之「—」代表「不提供」。
- 上表內之「/」代表「不適用」。
- 「Terrace Apartment」、「Garden Apartment」及「Courtyard Penthouse」僅為市場推廣之用的名稱，並不會於關於發展項目的任何公契、臨時買賣合約、買賣合約、轉讓契及契據出現。經批准的建築圖則上顯示的名稱為：第1座1樓A單位（即第1座1樓Terrace Apartment）；第2座地下B單位（即第2座地下Garden Apartment）；第3座地下B單位（即第3座地下Garden Apartment）；第7座地下A單位（即第7座地下Garden Apartment）；第7座11樓Penthouse（即第7座11樓Courtyard Penthouse）；第8座地下B單位（即第8座地下Garden Apartment）；第8座11樓Penthouse（即第8座11樓Courtyard Penthouse）。

# FITTINGS, FINISHES AND APPLIANCES

## 裝置、裝修物料及設備

### Schedule of Mechanical & Electrical Provisions for Residential Property

#### 住宅單位機電裝置數量說明表

Location 位置	Provisions 裝置	Tower 5 第5座				Tower 6 第6座			
		1/F 1樓		2/F - 3/F, 5/F - 10/F 2樓至3樓、5樓 至10樓	11/F 11樓	1/F 1樓		2/F - 3/F, 5/F - 10/F 2樓至3樓、5樓 至10樓	11/F 11樓
		Flat A A單位	Flat B B單位	Flat A & B A及B單位	Sky Pool Penthouse	Flat A A單位	Flat B B單位	Flat A & B A及B單位	Sky Pool Penthouse
Ensuite 3 套房 3	Twin Socket Outlet 雙位電插座				2				2
	Telephone Outlet 電話插座				1				1
	TV/ FM Outlet 電視 / 電台天線插座				1				1
	Lighting Point 燈位				1				1
	Lighting Switch 燈掣				2				2
	Switch for AC indoor Unit 空調室內機開關				1				1
	On/Off Switch for Exhaust Fan 抽氣扇開關掣				1				1
Kitchen 廚房	Single Socket Outlet 單位電插座	5	5	5	2	5	5	5	2
	Twin Socket Outlet 雙位電插座	3	3	3	1	3	3	3	1
	Lighting Point 燈位	9	9	9	3	9	9	9	3
	Switch for Oven 焗爐開關掣	1	1	1	—	1	1	1	—
	Switch for Induction Cooker 電磁爐開關掣	1	1	1	1	1	1	1	1
	Switch for Steamer 蒸爐開關掣	—	—	—	—	—	—	—	—
	Fused Spur Unit 保險絲接線位	6	6	6	5	6	6	6	5
	Switch for AC indoor Unit 空調室內機開關	1	1	1	1	1	1	1	1
	Gas Water Heater Remote Controller 煤氣熱水爐恆溫掣	1	1	1	1	1	1	1	1
	Door Bell 門鈴	1	1	1	1	1	1	1	1
	Town Gas Connection Point 煤氣接駁點	1	1	1	1	1	1	1	1
	Water Inlet / Outlet Connection Point for Dish Washer 洗碗機來 / 去水位接駁點	—	—	—	1	—	—	—	1
	Water Inlet / Outlet Connection Point for Washing Machine 洗衣機來 / 去水位接駁點	1	1	1	—	1	1	1	—
Master Bathroom 主人浴室	Single Socket Outlet 單位電插座	1	1	1	1	1	1	1	1
	Twin Socket Outlet 雙位電插座	1	1	1	1	1	1	1	1
	TV/ FM Outlet 電視 / 電台天線插座	1	1	1	1	1	1	1	1
	Lighting Point 燈位	6	6	6	6	6	6	6	6
	Gas Water Heater Remote Controller 煤氣熱水爐恆溫掣	1	1	1	1	1	1	1	1
	Switch for Thermal Ventilator 浴室寶開關	1	1	1	1	1	1	1	1
	Fused Spur Unit for Motorized Curtain 電動窗簾保險絲接線位	1	1	1	1	1	1	1	1
	Fused Spur Unit 保險絲接線位	2	2	2	2	2	2	2	2

#### Notes:

- The symbol “ — ” as shown in the above table denotes “Not provided”.
- The symbol “ / ” as shown in the above table denotes “Not applicable”.
- “Terrace Apartment”, “Garden Apartment” and “Courtyard Penthouse” are names for marketing purposes only and will not appear in any Deed of Mutual Covenant, the Preliminary Agreement for Sale and Purchase, Agreement for Sale and Purchase, Assignment, or any other title deeds and documents relating to the Development. The names as appearing on the approved building plans are: Flat A on 1/F of Tower 1 for Terrace Apartment on 1/F of Tower 1; Flat B on G/F of Tower 2 for Garden Apartment on G/F of Tower 2; Flat B on G/F of Tower 3 for Garden Apartment on G/F of Tower 3; Flat A on G/F of Tower 7 for Garden Apartment on G/F of Tower 7; Penthouse on 11/F of Tower 7 for Courtyard Penthouse on 11/F of Tower 7; Flat B on G/F of Tower 8 for Garden Apartment on G/F of Tower 8; Penthouse on 11/F of Tower 8 for Courtyard Penthouse on 11/F of Tower 8.

#### 備註:

- 上表內之「—」代表「不提供」。
- 上表內之「/」代表「不適用」。
- 「Terrace Apartment」、「Garden Apartment」及「Courtyard Penthouse」僅為市場推廣之用的名稱，並不會於關於發展項目的任何公契、臨時買賣合約、買賣合約、轉讓契及契據出現。經批准的建築圖則上顯示的名稱為：第1座1樓A單位（即第1座1樓Terrace Apartment）；第2座地下B單位（即第2座地下Garden Apartment）；第3座地下B單位（即第3座地下Garden Apartment）；第7座地下A單位（即第7座地下Garden Apartment）；第7座11樓Penthouse（即第7座11樓Courtyard Penthouse）；第8座地下B單位（即第8座地下Garden Apartment）；第8座11樓Penthouse（即第8座11樓Courtyard Penthouse）。

## FITTINGS, FINISHES AND APPLIANCES

### 裝置、裝修物料及設備

#### Schedule of Mechanical & Electrical Provisions for Residential Property

#### 住宅單位機電裝置數量說明表

Location 位置	Provisions 裝置	Tower 5 第5座				Tower 6 第6座			
		1/F 1樓		2/F - 3/F, 5/F - 10/F 2樓至3樓、5樓 至10樓	11/F 11樓	1/F 1樓		2/F - 3/F, 5/F - 10/F 2樓至3樓、5樓 至10樓	11/F 11樓
		Flat A A單位	Flat B B單位	Flat A & B A及B單位	Sky Pool Penthouse	Flat A A單位	Flat B B單位	Flat A & B A及B單位	Sky Pool Penthouse
Bathroom 1 浴室 1	Twin Socket Outlet 雙位電插座	1	1	1	1	1	1	1	1
	Lighting Point 燈位	3	3	3	3	3	3	3	3
	Gas Water Heater Remote Controller 煤氣熱水爐恆溫掣	1	1	1	1	1	1	1	1
	Fused Spur Unit 保險絲接線位	2	2	2	2	2	2	2	2
Bathroom 2 浴室 2	Twin Socket Outlet 雙位電插座	1	1	1	1	1	1	1	1
	Lighting Point 燈位	3	3	3	3	3	3	3	3
	Gas Water Heater Remote Controller 煤氣熱水爐恆溫掣	1	1	1	1	1	1	1	1
	Fused Spur Unit 保險絲接線位	2	2	2	2	2	2	2	2
Bathroom 3 浴室 3	Twin Socket Outlet 雙位電插座	/	/	/	1	/	/	/	1
	Lighting Point 燈位	/	/	/	3	/	/	/	3
	Gas Water Heater Remote Controller 煤氣熱水爐恆溫掣	/	/	/	1	/	/	/	1
	Fused Spur Unit 保險絲接線位	/	/	/	2	/	/	/	2
Powder Room 客廳洗手間	Lighting Point 燈位	/	/	/	2	/	/	/	2
	Fused Spur Unit 保險絲接線位	/	/	/	2	/	/	/	2
Utility Room with Lavatory 附有洗手間之工作間	Twin Socket Outlet 雙位電插座	1	1	1	1	1	1	1	1
	Lighting Point 燈位	2	2	2	2	2	2	2	2
	Lighting Switch 燈掣	2	2	2	2	2	2	2	2
	Switch for Exhaust Fan 抽氣扇開關掣	1	1	1	1	1	1	1	1
	Fused Spur Unit 保險絲接線位	2	2	2	3	2	2	2	3
	Switch for AC indoor Unit 空調室內機開關	1	1	1	1	1	1	1	1
	Air-conditioner Central Controller 冷氣中央控制器	—	—	—	1	—	—	—	1
	Town Gas Meter 煤氣計量錶	1	1	1	1	1	1	1	1
	Miniature Circuit Breaker Board 微型斷路箱	1	1	1	1	1	1	1	1
Utility Platform 工作平台	Lighting Point 燈位	1	1	1	1	1	1	1	1
Air-conditioner Platform 空調機平台	Switch for A/C Outdoor Unit 空調室外機開關	6	6	6	/	6	6	6	/
Balcony 露台	Lighting Point 燈位	1	1	1	1	1	1	1	1

#### Notes:

- The symbol “—” as shown in the above table denotes “Not provided”.
- The symbol “/” as shown in the above table denotes “Not applicable”.
- “Terrace Apartment”, “Garden Apartment” and “Courtyard Penthouse” are names for marketing purposes only and will not appear in any Deed of Mutual Covenant, the Preliminary Agreement for Sale and Purchase, Agreement for Sale and Purchase, Assignment, or any other title deeds and documents relating to the Development. The names as appearing on the approved building plans are: Flat A on 1/F of Tower 1 for Terrace Apartment on 1/F of Tower 1; Flat B on G/F of Tower 2 for Garden Apartment on G/F of Tower 2; Flat B on G/F of Tower 3 for Garden Apartment on G/F of Tower 3; Flat A on G/F of Tower 7 for Garden Apartment on G/F of Tower 7; Penthouse on 11/F of Tower 7 for Courtyard Penthouse on 11/F of Tower 7; Flat B on G/F of Tower 8 for Garden Apartment on G/F of Tower 8; Penthouse on 11/F of Tower 8 for Courtyard Penthouse on 11/F of Tower 8.

#### 備註:

- 上表內之「—」代表「不提供」。
- 上表內之「/」代表「不適用」。
- 「Terrace Apartment」、「Garden Apartment」及「Courtyard Penthouse」僅為市場推廣之用的名稱，並不會於關於發展項目的任何公契、臨時買賣合約、買賣合約、轉讓契及契據出現。經批准的建築圖則上顯示的名稱為：第1座1樓A單位（即第1座1樓Terrace Apartment）；第2座地下B單位（即第2座地下Garden Apartment）；第3座地下B單位（即第3座地下Garden Apartment）；第7座地下A單位（即第7座地下Garden Apartment）；第7座11樓Penthouse（即第7座11樓Courtyard Penthouse）；第8座地下B單位（即第8座地下Garden Apartment）；第8座11樓Penthouse（即第8座11樓Courtyard Penthouse）。

# FITTINGS, FINISHES AND APPLIANCES

## 裝置、裝修物料及設備

### Schedule of Mechanical & Electrical Provisions for Residential Property

#### 住宅單位機電裝置數量說明表

Location 位置	Provisions 裝置	Tower 5 第5座				Tower 6 第6座			
		1/F 1樓		2/F - 3/F, 5/F - 10/F 2樓至3樓、5樓 至10樓	11/F 11樓	1/F 1樓		2/F - 3/F, 5/F - 10/F 2樓至3樓、5樓 至10樓	11/F 11樓
		Flat A A單位	Flat B B單位	Flat A & B A及B單位	Sky Pool Penthouse	Flat A A單位	Flat B B單位	Flat A & B A及B單位	Sky Pool Penthouse
Flat Roof 平台	Lighting Point 燈位				6				6
	Switch for Filtration Plant 泳池過濾系統開關				1				1
	Underwater Lighting in Swimming Pool 泳池水下燈				8				8
	Water Inlet Connection Point for Swimming Pool Filtration Cabinet 游泳池過濾櫃來水位接駁點				1				1
	Water Outlet Connection Point for Swimming Pool Filtration Cabinet 游泳池過濾櫃去水位接駁點				2				2
	Single Waterproof Socket Outlet 防水單位電插座				1				1
Roof 天台	Lighting Point 燈位				11				11
	Single Waterproof Socket Outlet 防水單位電插座				1				1
	Fused Spur Unit 保險絲接線位				1				1
Utility Room 工作間	Twin Socket Outlet 雙位電插座				2				2
	Lighting Point 燈位				1				1
	Lighting Switch 燈掣				1				1
	Fused Spur Unit 保險絲接線位				1				1
	Water Inlet / Outlet Connection Point for Washing Machine 洗衣機來 / 去水位接駁點				1				1
Store Room 儲物室	Lighting Point 燈位				1				1
	Lighting Switch 燈掣				2				2
Outdoor VRV Area 室外變頻中央空調系統空間	Switch for AC outdoor Unit 空調室外機開關				2				2

Notes:

- The symbol “ — ” as shown in the above table denotes “Not provided”.
- The symbol “ / ” as shown in the above table denotes “Not applicable”.
- “Terrace Apartment”, “Garden Apartment” and “Courtyard Penthouse” are names for marketing purposes only and will not appear in any Deed of Mutual Covenant, the Preliminary Agreement for Sale and Purchase, Agreement for Sale and Purchase, Assignment, or any other title deeds and documents relating to the Development. The names as appearing on the approved building plans are: Flat A on 1/F of Tower 1 for Terrace Apartment on 1/F of Tower 1; Flat B on G/F of Tower 2 for Garden Apartment on G/F of Tower 2; Flat B on G/F of Tower 3 for Garden Apartment on G/F of Tower 3; Flat A on G/F of Tower 7 for Garden Apartment on G/F of Tower 7; Penthouse on 11/F of Tower 7 for Courtyard Penthouse on 11/F of Tower 7; Flat B on G/F of Tower 8 for Garden Apartment on G/F of Tower 8; Penthouse on 11/F of Tower 8 for Courtyard Penthouse on 11/F of Tower 8.

備註:

- 上表內之「—」代表「不提供」。
- 上表內之「/」代表「不適用」。
- 「Terrace Apartment」、「Garden Apartment」及「Courtyard Penthouse」僅為市場推廣之用的名稱，並不會於關於發展項目的任何公契、臨時買賣合約、買賣合約、轉讓契及契據出現。經批准的建築圖則上顯示的名稱為：第1座1樓A單位（即第1座1樓Terrace Apartment）；第2座地下B單位（即第2座地下Garden Apartment）；第3座地下B單位（即第3座地下Garden Apartment）；第7座地下A單位（即第7座地下Garden Apartment）；第7座11樓Penthouse（即第7座11樓Courtyard Penthouse）；第8座地下B單位（即第8座地下Garden Apartment）；第8座11樓Penthouse（即第8座11樓Courtyard Penthouse）。



# FITTINGS, FINISHES AND APPLIANCES

## 裝置、裝修物料及設備

### Schedule of Mechanical & Electrical Provisions for Residential Property

#### 住宅單位機電裝置數量說明表

Location 位置	Provisions 裝置	Tower 7 第7座					Tower 8 第8座						
		G/F 地下	1/F 1樓		2/F - 3/F, 5/F - 10/F 2樓至 3樓、5樓至 10樓	11/F 11樓	G/F 地下	1/F 1樓		2/F - 3/F, 5/F - 8/F & 10/F 2樓至 3樓、5樓至 8樓及10樓	9/F 9樓		11/F 11樓
		• Garden Apartment	Flat A A單位	Flat B B單位	Flat A & B A及B單位	• Courtyard Penthouse	• Garden Apartment	Flat A A單位	Flat B B單位	Flat A & B A及B單位	Flat A A單位	Flat B B單位	• Courtyard Penthouse
Private Lift Lobby 私人電梯大堂	Lighting Point 燈位		5	5	5	5		5	5	5	5	6	5
	Fused Spur Unit 保險絲接線位		1	1	1	1		1	1	1	1	1	1
	Lighting Switch 燈掣	—	—	—	—	—	—	—	—	—	—	1	—
	Door Bell Push Button 門鈴按鈕		1	1	1	1		1	1	1	1	1	1
Living Room & Dining Room 客廳及飯廳	Single Socket Outlet 單位電插座	1	1	1	1	4	1	1	1	1	1	—	4
	Twin Socket Outlet 雙位電插座	3	3	3	3	4	3	3	3	3	3	5	4
	Telephone Outlet 電話插座	2	2	2	2	2	2	2	2	2	2	1	2
	TV/ FM Outlet 電視 / 電台天線插座	2	2	2	2	2	2	2	2	2	2	1	2
	Lighting Point 燈位	4	4	4	4	24	4	4	4	4	4	32	24
	Lighting Switch 燈掣	6	6	5	6	12	6	5	6	6	6	9	11
	Fused Spur Unit for Motorized Curtain 電動窗簾保險絲電源接線位	1	1	1	1	2	1	1	1	1	1	—	1
	Fused Spur Unit 保險絲接線位	—	—	—	—	—	—	—	—	—	—	5	—
	HDMI In/Out Point HDMI 接駁位	—	—	—	—	—	—	—	—	—	—	1	—
	Ethennet Port 互聯網插座	—	—	—	—	—	—	—	—	—	—	1	—
	Switch for AC indoor Unit 空調室內機開關	2	2	2	2	5	2	2	2	2	2	2	5
	Switch for Oven 焗爐開關掣	—	—	—	—	1	—	—	—	—	—	—	1
	Switch for Steamer 蒸爐開關掣	—	—	—	—	1	—	—	—	—	—	—	1
	Switch for Exhaust Fan 抽氣扇開關掣	2	2	2	2	2	2	2	2	2	2	1	2
Video Door phone 視像對講機	1	—	—	—	1	1	—	—	—	—	—	1	
Door Phone 門口對講機	—	1	1	1	—	—	1	1	1	1	1	—	

#### Notes:

- The symbol “ — ” as shown in the above table denotes “Not provided”.
- The symbol “ / ” as shown in the above table denotes “Not applicable”.
- “Terrace Apartment”, “Garden Apartment” and “Courtyard Penthouse” are names for marketing purposes only and will not appear in any Deed of Mutual Covenant, the Preliminary Agreement for Sale and Purchase, Agreement for Sale and Purchase, Assignment, or any other title deeds and documents relating to the Development. The names as appearing on the approved building plans are: Flat A on 1/F of Tower 1 for Terrace Apartment on 1/F of Tower 1; Flat B on G/F of Tower 2 for Garden Apartment on G/F of Tower 2; Flat B on G/F of Tower 3 for Garden Apartment on G/F of Tower 3; Flat A on G/F of Tower 7 for Garden Apartment on G/F of Tower 7; Penthouse on 11/F of Tower 7 for Courtyard Penthouse on 11/F of Tower 7; Flat B on G/F of Tower 8 for Garden Apartment on G/F of Tower 8; Penthouse on 11/F of Tower 8 for Courtyard Penthouse on 11/F of Tower 8.

#### 備註:

- 上表內之「—」代表「不提供」。
- 上表內之「/」代表「不適用」。
- 「Terrace Apartment」、「Garden Apartment」及「Courtyard Penthouse」僅為市場推廣之用的名稱，並不會於關於發展項目的任何公契、臨時買賣合約、買賣合約、轉讓契及契據出現。經批准的建築圖則上顯示的名稱為：第1座1樓A單位（即第1座1樓Terrace Apartment）；第2座地下B單位（即第2座地下Garden Apartment）；第3座地下B單位（即第3座地下Garden Apartment）；第7座地下A單位（即第7座地下Garden Apartment）；第7座11樓Penthouse（即第7座11樓Courtyard Penthouse）；第8座地下B單位（即第8座地下Garden Apartment）；第8座11樓Penthouse（即第8座11樓Courtyard Penthouse）。



# FITTINGS, FINISHES AND APPLIANCES

## 裝置、裝修物料及設備

### Schedule of Mechanical & Electrical Provisions for Residential Property

#### 住宅單位機電裝置數量說明表

Location 位置	Provisions 裝置	Tower 7 第7座					Tower 8 第8座						
		G/F 地下	1/F 1樓		2/F - 3/F, 5/F - 10/F 2樓至 3樓、5樓至 10樓	11/F 11樓	G/F 地下	1/F 1樓		2/F - 3/F, 5/F - 8/F & 10/F 2樓至 3樓、5樓至 8樓及10樓	9/F 9樓		11/F 11樓
		• Garden Apartment	Flat A A單位	Flat B B單位	Flat A & B A及B單位	• Courtyard Penthouse	• Garden Apartment	Flat A A單位	Flat B B單位	Flat A & B A及B單位	Flat A A單位	Flat B B單位	• Courtyard Penthouse
Master Bedroom 主人睡房	Twin Socket Outlet 雙位電插座	2	2	2	2	3	2	2	2	2	2	4	3
	Telephone Outlet 電話插座	2	2	2	2	2	2	2	2	2	2	1	2
	TV/ FM Outlet 電視 / 電台天線插座	2	2	2	2	2	2	2	2	2	2	1	2
	Panic Alarm Button 警鐘按鈕	1	1	1	1	1	1	1	1	1	1	1	1
	Lighting Point 燈位	1	1	1	1	3	1	1	1	1	1	6	3
	Lighting Switch 燈掣	2	2	3	2	3	2	3	2	2	2	5	3
	HDMI In/Out Point HDMI 接駁位	—	—	—	—	—	—	—	—	—	—	2	—
	Ethennet Port 互聯網插座	—	—	—	—	—	—	—	—	—	—	1	—
	Single Socket Outlet 單位電插座	—	—	—	—	—	—	—	—	—	—	4	—
	Fused Spur Unit 保險絲接線位	—	—	—	—	—	—	—	—	—	—	2	—
	Fused Spur Unit for Motorized Curtain 電動窗簾保險絲電源接線位	1	1	1	1	1	1	1	1	1	1	—	1
	Switch for AC indoor Unit 空調室內機開關	1	1	1	1	1	1	1	1	1	1	1	1
Bedroom 1 睡房 1	Twin Socket Outlet 雙位電插座	2	2	2	2	—	2	2	2	2	2	3	—
	Single Socket Outlet 單位電插座	—	—	—	—	—	—	—	—	—	—	2	—
	Telephone Outlet 電話插座	1	1	1	1	—	1	1	1	1	1	1	—
	TV/ FM Outlet 電視 / 電台天線插座	1	1	1	1	—	1	1	1	1	1	1	—
	Lighting Point 燈位	1	1	1	1	—	1	1	1	1	1	6	—
	Lighting Switch 燈掣	1	1	1	1	—	1	1	1	1	1	2	—
	HDMI In/Out Port HDMI 接駁位	—	—	—	—	—	—	—	—	—	—	2	—
	Ethennet Port 互聯網插座	—	—	—	—	—	—	—	—	—	—	1	—
	Fused Spur Unit 保險絲接線位	—	—	—	—	—	—	—	—	—	—	2	—
Switch for AC indoor Unit 空調室內機開關	1	1	1	1	—	1	1	1	1	1	1	—	
Entrance Lobby 電梯大堂	Door Bell Push Button 門鈴按鈕	1	—	—	—	—	1	—	—	—	—	—	
Bedroom 2 睡房 2	Twin Socket Outlet 雙位電插座	2	2	2	2	—	2	2	2	2	—	—	
	Telephone Outlet 電話插座	1	1	1	1	—	1	1	1	1	—	—	
	TV/ FM Outlet 電視 / 電台天線插座	1	1	1	1	—	1	1	1	1	—	—	
	Lighting Point 燈位	1	1	1	1	—	1	1	1	1	—	—	
	Lighting Switch 燈掣	1	1	1	1	—	1	1	1	1	—	—	
	Switch for AC indoor Unit 空調室內機開關	1	1	1	1	—	1	1	1	1	—	—	

Notes:

- The symbol “—” as shown in the above table denotes “Not provided”.
- The symbol “/” as shown in the above table denotes “Not applicable”.
- “Terrace Apartment”, “Garden Apartment” and “Courtyard Penthouse” are names for marketing purposes only and will not appear in any Deed of Mutual Covenant, the Preliminary Agreement for Sale and Purchase, Agreement for Sale and Purchase, Assignment, or any other title deeds and documents relating to the Development. The names as appearing on the approved building plans are: Flat A on 1/F of Tower 1 for Terrace Apartment on 1/F of Tower 1; Flat B on G/F of Tower 2 for Garden Apartment on G/F of Tower 2; Flat B on G/F of Tower 3 for Garden Apartment on G/F of Tower 3; Flat A on G/F of Tower 7 for Garden Apartment on G/F of Tower 7; Penthouse on 11/F of Tower 7 for Courtyard Penthouse on 11/F of Tower 7; Flat B on G/F of Tower 8 for Garden Apartment on G/F of Tower 8; Penthouse on 11/F of Tower 8 for Courtyard Penthouse on 11/F of Tower 8.

備註:

- 上表內之「—」代表「不提供」。
- 上表內之「/」代表「不適用」。
- 「Terrace Apartment」、「Garden Apartment」及「Courtyard Penthouse」僅為市場推廣之用的名稱，並不會於關於發展項目的任何公契、臨時買賣合約、買賣合約、轉讓契及契據出現。經批准的建築圖則上顯示的名稱為：第1座1樓A單位（即第1座1樓Terrace Apartment）；第2座地下B單位（即第2座地下Garden Apartment）；第3座地下B單位（即第3座地下Garden Apartment）；第7座地下A單位（即第7座地下Garden Apartment）；第7座11樓Penthouse（即第7座11樓Courtyard Penthouse）；第8座地下B單位（即第8座地下Garden Apartment）；第8座11樓Penthouse（即第8座11樓Courtyard Penthouse）。

# FITTINGS, FINISHES AND APPLIANCES

## 裝置、裝修物料及設備

### Schedule of Mechanical & Electrical Provisions for Residential Property

#### 住宅單位機電裝置數量說明表

Location 位置	Provisions 裝置	Tower 7 第7座					Tower 8 第8座						
		G/F 地下	1/F 1樓		2/F - 3/F, 5/F - 10/F 2樓至 3樓、5樓至 10樓	11/F 11樓	G/F 地下	1/F 1樓		2/F - 3/F, 5/F - 8/F & 10/F 2樓至 3樓、5樓至 8樓及10樓	9/F 9樓		11/F 11樓
		• Garden Apartment	Flat A A單位	Flat B B單位	Flat A & B A及B單位	• Courtyard Penthouse	• Garden Apartment	Flat A A單位	Flat B B單位	Flat A & B A及B單位	Flat A A單位	Flat B B單位	• Courtyard Penthouse
Store Room 儲物室	Lighting Point 燈位					1							1
	Lighting Switch 燈掣					1							1
Flat Roof 平台	Lighting Point 燈位					9							9
Ensuite 1 套房 1	Twin Socket Outlet 雙位電插座					2							2
	Telephone Outlet 電話插座					1							1
	TV/ FM Outlet 電視 / 電台天線插座					1							1
	Lighting Point 燈位					1							1
	Lighting Switch 燈掣					2							2
	Switch for AC indoor Unit 空調室內機開關					1							1
	Switch for Exhaust Fan 抽氣扇開關掣					1							1
Ensuite 2 套房 2	Twin Socket Outlet 雙位電插座					2							2
	Telephone Outlet 電話插座					1							1
	TV/ FM Outlet 電視 / 電台天線插座					1							1
	Lighting Point 燈位					1							1
	Lighting Switch 燈掣					3							3
	Switch for AC indoor Unit 空調室內機開關					1							1
	Switch for Exhaust Fan 抽氣扇開關掣					1							1
Ensuite 3 套房 3	Twin Socket Outlet 雙位電插座					2							2
	Telephone Outlet 電話插座					1							1
	TV/ FM Outlet 電視 / 電台天線插座					1							1
	Lighting Point 燈位					1							1
	Lighting Switch 燈掣					2							2
	Switch for AC indoor Unit 空調室內機開關					1							1
	Switch for Exhaust Fan 抽氣扇開關掣					1							1

Notes:

- The symbol “ — ” as shown in the above table denotes “Not provided”.
- The symbol “ / ” as shown in the above table denotes “Not applicable”.
- “Terrace Apartment”, “Garden Apartment” and “Courtyard Penthouse” are names for marketing purposes only and will not appear in any Deed of Mutual Covenant, the Preliminary Agreement for Sale and Purchase, Agreement for Sale and Purchase, Assignment, or any other title deeds and documents relating to the Development. The names as appearing on the approved building plans are: Flat A on 1/F of Tower 1 for Terrace Apartment on 1/F of Tower 1; Flat B on G/F of Tower 2 for Garden Apartment on G/F of Tower 2; Flat B on G/F of Tower 3 for Garden Apartment on G/F of Tower 3; Flat A on G/F of Tower 7 for Garden Apartment on G/F of Tower 7; Penthouse on 11/F of Tower 7 for Courtyard Penthouse on 11/F of Tower 7; Flat B on G/F of Tower 8 for Garden Apartment on G/F of Tower 8; Penthouse on 11/F of Tower 8 for Courtyard Penthouse on 11/F of Tower 8.

備註:

- 上表內之「—」代表「不提供」。
- 上表內之「/」代表「不適用」。
- 「Terrace Apartment」、「Garden Apartment」及「Courtyard Penthouse」僅為市場推廣之用的名稱，並不會於關於發展項目的任何公契、臨時買賣合約、買賣合約、轉讓契及契據出現。經批准的建築圖則上顯示的名稱為：第1座1樓A單位（即第1座1樓Terrace Apartment）；第2座地下B單位（即第2座地下Garden Apartment）；第3座地下B單位（即第3座地下Garden Apartment）；第7座地下A單位（即第7座地下Garden Apartment）；第7座11樓Penthouse（即第7座11樓Courtyard Penthouse）；第8座地下B單位（即第8座地下Garden Apartment）；第8座11樓Penthouse（即第8座11樓Courtyard Penthouse）。

# FITTINGS, FINISHES AND APPLIANCES

## 裝置、裝修物料及設備

### Schedule of Mechanical & Electrical Provisions for Residential Property

#### 住宅單位機電裝置數量說明表

Location 位置	Provisions 裝置	Tower 7 第7座					Tower 8 第8座						
		G/F 地下	1/F 1樓		2/F - 3/F, 5/F - 10/F 2樓至 3樓、5樓至 10樓	11/F 11樓	G/F 地下	1/F 1樓		2/F - 3/F, 5/F - 8/F & 10/F 2樓至 3樓、5樓至 8樓及10樓	9/F 9樓		11/F 11樓
		• Garden Apartment	Flat A A單位	Flat B B單位	Flat A & B A及B單位	• Courtyard Penthouse	• Garden Apartment	Flat A A單位	Flat B B單位	Flat A & B A及B單位	Flat A A單位	Flat B B單位	• Courtyard Penthouse
Kitchen 廚房	Single Socket Outlet 單位電插座	3	5	5	5	2	3	5	5	5	5	2	2
	Twin Socket Outlet 雙位電插座	3	3	3	3	1	3	3	3	3	3	5	1
	Lighting Point 燈位	6	9	9	9	3	6	9	9	9	9	4	3
	Lighting Switch 燈掣	1	—	—	—	—	1	—	—	—	—	1	—
	Switch for Oven 焗爐開關掣	1	1	1	1	—	1	1	1	1	1	1	—
	Switch for Steamer 蒸爐開關掣	1	—	—	—	—	1	—	—	—	—	1	—
	Switch for Induction Cooker 電磁爐開關掣	1	1	1	1	1	1	1	1	1	1	1	1
	Switch for Coffee Machine 咖啡機開關	—	—	—	—	—	—	—	—	—	—	1	—
	Fused Spur Unit 保險絲接線位	7	6	6	6	5	7	6	6	6	6	4	5
	Switch for A/C indoor Unit 空調室內機開關	1	1	1	1	1	1	1	1	1	1	1	1
	Gas Water Heater Remote Controller 煤氣熱水爐恆溫掣	1	1	1	1	1	1	1	1	1	1	1	1
	Door Bell 門鈴	1	1	1	1	1	1	1	1	1	1	1	1
	Town Gas Connection Point 煤氣接駁點	1	1	1	1	1	1	1	1	1	1	1	1
	Water Inlet / Outlet Connection Point for Dish Washer 洗碗機來 / 去水位接駁點	1	—	—	—	1	1	—	—	—	—	—	1
Water Inlet / Outlet Connection Point for Washing Machine 洗衣機來 / 去水位接駁點	—	1	1	1	—	—	1	1	1	1	—	—	
Ensuite 套房	Twin Socket Outlet 雙位電插座	2	2	2	2		2	2	2	2	2	5	
	Telephone Outlet 電話插座	1	1	1	1		1	1	1	1	1	1	
	TV/ FM Outlet 電視 / 電台天線插座	1	1	1	1		1	1	1	1	1	1	
	Lighting Point 燈位	1	1	1	1		1	1	1	1	1	4	
	Lighting Switch 燈掣	3	3	3	3		3	3	3	3	3	4	
	Single Socket Outlet 單位電插座	—	—	—	—		—	—	—	—	—	2	
	HDMI In/Out Point HDMI 接駁位	—	—	—	—		—	—	—	—	—	2	
	Ethennet Port 互聯網插座	—	—	—	—		—	—	—	—	—	1	
	Fused Spur Unit 保險絲接線位	—	—	—	—		—	—	—	—	—	3	
	Switch for AC indoor Unit 空調室內機開關	1	1	1	1		1	1	1	1	1	1	
On/Off Switch for Exhaust Fan 抽氣扇開關掣	1	1	1	1		1	1	1	1	1	1		

#### Notes:

- The symbol “—” as shown in the above table denotes “Not provided”.
- The symbol “/” as shown in the above table denotes “Not applicable”.
- “Terrace Apartment”, “Garden Apartment” and “Courtyard Penthouse” are names for marketing purposes only and will not appear in any Deed of Mutual Covenant, the Preliminary Agreement for Sale and Purchase, Agreement for Sale and Purchase, Assignment, or any other title deeds and documents relating to the Development. The names as appearing on the approved building plans are: Flat A on 1/F of Tower 1 for Terrace Apartment on 1/F of Tower 1; Flat B on G/F of Tower 2 for Garden Apartment on G/F of Tower 2; Flat B on G/F of Tower 3 for Garden Apartment on G/F of Tower 3; Flat A on G/F of Tower 7 for Garden Apartment on G/F of Tower 7; Penthouse on 11/F of Tower 7 for Courtyard Penthouse on 11/F of Tower 7; Flat B on G/F of Tower 8 for Garden Apartment on G/F of Tower 8; Penthouse on 11/F of Tower 8 for Courtyard Penthouse on 11/F of Tower 8.

#### 備註:

- 上表內之“—”代表「不提供」。
- 上表內之“/”代表「不適用」。
- 「Terrace Apartment」、「Garden Apartment」及「Courtyard Penthouse」僅為市場推廣之用的名稱，並不會於關於發展項目的任何公契、臨時買賣合約、買賣合約、轉讓契及契據出現。經批准的建築圖則上顯示的名稱為：第1座1樓A單位（即第1座1樓Terrace Apartment）；第2座地下B單位（即第2座地下Garden Apartment）；第3座地下B單位（即第3座地下Garden Apartment）；第7座地下A單位（即第7座地下Garden Apartment）；第7座11樓Penthouse（即第7座11樓Courtyard Penthouse）；第8座地下B單位（即第8座地下Garden Apartment）；第8座11樓Penthouse（即第8座11樓Courtyard Penthouse）。

# FITTINGS, FINISHES AND APPLIANCES

## 裝置、裝修物料及設備

### Schedule of Mechanical & Electrical Provisions for Residential Property

#### 住宅單位機電裝置數量說明表

Location 位置	Provisions 裝置	Tower 7 第7座					Tower 8 第8座						
		G/F 地下	1/F 1樓		2/F - 3/F, 5/F - 10/F 2樓至 3樓、5樓至 10樓	11/F 11樓	G/F 地下	1/F 1樓		2/F - 3/F, 5/F - 8/F & 10/F 2樓至 3樓、5樓至 8樓及10樓	9/F 9樓		11/F 11樓
		• Garden Apartment	Flat A A單位	Flat B B單位	Flat A & B A及B單位	• Courtyard Penthouse	• Garden Apartment	Flat A A單位	Flat B B單位	Flat A & B A及B單位	Flat A A單位	Flat B B單位	• Courtyard Penthouse
Store Room 儲物室	Twin Socket Outlet 雙位電插座	1	/	/	/	/	1	/	/	/	/	/	/
	Lighting Point 燈位	1	/	/	/	/	1	/	/	/	/	/	/
	Lighting Switch 燈掣	1	/	/	/	/	1	/	/	/	/	/	/
	Switch for A/C indoor Unit 空調室內機開關	1	/	/	/	/	1	/	/	/	/	/	/
	Fused Spur Unit 保險絲接線位	1	/	/	/	/	1	/	/	/	/	/	/
	Air-conditioner Central Controller 冷氣中央 控制器	1	/	/	/	/	1	/	/	/	/	/	/
	Miniature Circuit Breaker Board 微型斷路箱	1	/	/	/	/	1	/	/	/	/	/	/
Master Bathroom 主人浴室	Single Socket Outlet 單位電插座	1	1	1	1	1	1	1	1	1	1	2	1
	Twin Socket Outlet 雙位電插座	1	1	1	1	1	1	1	1	1	1	—	1
	TV/ FM Outlet 電視 / 電台天線插座	1	1	1	1	1	1	1	1	1	1	—	1
	Shaver Outlet 剃鬚器插座	—	—	—	—	—	—	—	—	—	—	1	—
	Lighting Switch 燈掣	—	—	—	—	—	—	—	—	—	—	1	—
	Switch for Heated Towel Rail 毛巾暖管開關	—	—	—	—	—	—	—	—	—	—	1	—
	Switch for Bath Tub 浴缸開關	—	—	—	—	—	—	—	—	—	—	1	—
	Lighting Point 燈位	6	6	6	6	6	6	6	6	6	6	6	6
	Gas Water Heater Remote Controller 煤氣熱 水爐遙溫掣	1	1	1	1	1	1	1	1	1	1	1	1
	Switch for Thermal Ventilator 浴室寶開關	1	1	1	1	1	1	1	1	1	1	1	1
	Fused Spur Unit for Motorized Curtain 電動 窗簾保險絲接線位	1	1	1	1	1	1	1	1	1	1	—	1
	Fused Spur Unit 保險絲接線位	2	2	2	2	2	2	2	2	2	2	3	2
Lavatory 洗手間	Lighting Point 燈位	1	/	/	/	/	1	/	/	/	/	/	/
	Town Gas Meter 煤氣計量錶	1	—	—	—	—	1	—	—	—	—	—	—
	Fused Spur Unit 保險絲接線位	2	/	/	/	/	2	/	/	/	/	/	/

Notes:

- The symbol “ — ” as shown in the above table denotes “Not provided”.
- The symbol “ / ” as shown in the above table denotes “Not applicable”.
- “Terrace Apartment”, “Garden Apartment” and “Courtyard Penthouse” are names for marketing purposes only and will not appear in any Deed of Mutual Covenant, the Preliminary Agreement for Sale and Purchase, Agreement for Sale and Purchase, Assignment, or any other title deeds and documents relating to the Development. The names as appearing on the approved building plans are: Flat A on 1/F of Tower 1 for Terrace Apartment on 1/F of Tower 1; Flat B on G/F of Tower 2 for Garden Apartment on G/F of Tower 2; Flat B on G/F of Tower 3 for Garden Apartment on G/F of Tower 3; Flat A on G/F of Tower 7 for Garden Apartment on G/F of Tower 7; Penthouse on 11/F of Tower 7 for Courtyard Penthouse on 11/F of Tower 7; Flat B on G/F of Tower 8 for Garden Apartment on G/F of Tower 8; Penthouse on 11/F of Tower 8 for Courtyard Penthouse on 11/F of Tower 8.

備註:

- 上表內之「—」代表「不提供」。
- 上表內之「/」代表「不適用」。
- 「Terrace Apartment」、「Garden Apartment」及「Courtyard Penthouse」僅為市場推廣之用的名稱，並不會於關於發展項目的任何公契、臨時買賣合約、買賣合約、轉讓契及契據出現。經批准的建築圖則上顯示的名稱為：第1座1樓A單位（即第1座1樓Terrace Apartment）；第2座地下B單位（即第2座地下Garden Apartment）；第3座地下B單位（即第3座地下Garden Apartment）；第7座地下A單位（即第7座地下Garden Apartment）；第7座11樓Penthouse（即第7座11樓Courtyard Penthouse）；第8座地下B單位（即第8座地下Garden Apartment）；第8座11樓Penthouse（即第8座11樓Courtyard Penthouse）。



# FITTINGS, FINISHES AND APPLIANCES

## 裝置、裝修物料及設備

### Schedule of Mechanical & Electrical Provisions for Residential Property

#### 住宅單位機電裝置數量說明表

Location 位置	Provisions 裝置	Tower 7 第7座					Tower 8 第8座						
		G/F 地下	1/F 1樓		2/F - 3/F, 5/F - 10/F 2樓至 3樓、5樓至 10樓	11/F 11樓	G/F 地下	1/F 1樓		2/F - 3/F, 5/F - 8/F & 10/F 2樓至 3樓、5樓至 8樓及10樓	9/F 9樓		11/F 11樓
		• Garden Apartment	Flat A A單位	Flat B B單位	Flat A & B A及B單位	• Courtyard Penthouse	• Garden Apartment	Flat A A單位	Flat B B單位	Flat A & B A及B單位	Flat A A單位	Flat B B單位	• Courtyard Penthouse
Bathroom 1 浴室1	Twin Socket Outlet 雙位電插座	1	1	1	1	1	1	1	1	1	1	—	1
	Single Socket Outlet 單位電插座	—	—	—	—	—	—	—	—	—	—	1	—
	Shaver Outlet 剃鬚器插座	—	—	—	—	—	—	—	—	—	—	1	—
	Lighting Point 燈位	3	3	3	3	3	3	3	3	3	3	2	3
	Gas Water Heater Remote Controller 煤氣熱水爐恆溫掣	1	1	1	1	1	1	1	1	1	1	1	1
	Fused Spur Unit 保險絲接線位	2	2	2	2	2	2	2	2	2	2	2	2
Bathroom 2 浴室2	Twin Socket Outlet 雙位電插座	1	1	1	1	1	1	1	1	1	1	—	1
	Lighting Point 燈位	3	3	3	3	3	3	3	3	3	3	2	3
	Single Socket Outlet 單位電插座	—	—	—	—	—	—	—	—	—	—	1	—
	Shaver Outlet 剃鬚器插座	—	—	—	—	—	—	—	—	—	—	1	—
	Gas Water Heater Remote Controller 煤氣熱水爐恆溫掣	1	1	1	1	1	1	1	1	1	1	1	1
	Fused Spur Unit 保險絲接線位	2	2	2	2	2	2	2	2	2	2	2	2
Bathroom 3 浴室3	Twin Socket Outlet 雙位電插座	/	/	/	/	1	/	/	/	/	/	/	1
	Lighting Point 燈位	/	/	/	/	3	/	/	/	/	/	/	3
	Gas Water Heater Remote Controller 煤氣熱水爐恆溫掣	/	/	/	/	1	/	/	/	/	/	/	1
	Fused Spur Unit 保險絲接線位	/	/	/	/	2	/	/	/	/	/	/	2
Powder Room 客廳洗手間	Lighting Point 燈位	/	/	/	/	2	/	/	/	/	/	/	2
	Fused Spur Unit 保險絲接線位	/	/	/	/	2	/	/	/	/	/	/	2
Utility Room with Lavatory 附有洗手間之工作間	Twin Socket Outlet 雙位電插座	/	1	1	1	1	/	1	1	1	1	2	1
	Lighting Point 燈位	/	2	2	2	2	/	2	2	2	2	2	2
	Lighting Switch 燈掣	/	2	2	2	2	/	2	2	2	2	2	2
	Switch for Exhaust Fan 抽氣扇開關掣	/	1	1	1	1	/	1	1	1	1	1	1
	Fused Spur Unit 保險絲接線位	/	2	2	2	3	/	2	2	2	2	2	3
	Switch for AC indoor Unit 空調室內機開關	/	1	1	1	1	/	1	1	1	1	1	1

#### Notes:

- The symbol “—” as shown in the above table denotes “Not provided”.
- The symbol “/” as shown in the above table denotes “Not applicable”.
- “Terrace Apartment”, “Garden Apartment” and “Courtyard Penthouse” are names for marketing purposes only and will not appear in any Deed of Mutual Covenant, the Preliminary Agreement for Sale and Purchase, Agreement for Sale and Purchase, Assignment, or any other title deeds and documents relating to the Development. The names as appearing on the approved building plans are: Flat A on 1/F of Tower 1 for Terrace Apartment on 1/F of Tower 1; Flat B on G/F of Tower 2 for Garden Apartment on G/F of Tower 2; Flat B on G/F of Tower 3 for Garden Apartment on G/F of Tower 3; Flat A on G/F of Tower 7 for Garden Apartment on G/F of Tower 7; Penthouse on 11/F of Tower 7 for Courtyard Penthouse on 11/F of Tower 7; Flat B on G/F of Tower 8 for Garden Apartment on G/F of Tower 8; Penthouse on 11/F of Tower 8 for Courtyard Penthouse on 11/F of Tower 8.

#### 備註:

- 上表內之“—”代表「不提供」。
- 上表內之“/”代表「不適用」。
- 「Terrace Apartment」、「Garden Apartment」及「Courtyard Penthouse」僅為市場推廣之用的名稱，並不會於關於發展項目的任何公契、臨時買賣合約、買賣合約、轉讓契及契據出現。經批准的建築圖則上顯示的名稱為：第1座1樓A單位（即第1座1樓Terrace Apartment）；第2座地下B單位（即第2座地下Garden Apartment）；第3座地下B單位（即第3座地下Garden Apartment）；第7座地下A單位（即第7座地下Garden Apartment）；第7座11樓Penthouse（即第7座11樓Courtyard Penthouse）；第8座地下B單位（即第8座地下Garden Apartment）；第8座11樓Penthouse（即第8座11樓Courtyard Penthouse）。



FITTINGS, FINISHES AND APPLIANCES

裝置、裝修物料及設備

Schedule of Mechanical & Electrical Provisions for Residential Property

住宅單位機電裝置數量說明表

Location 位置	Provisions 裝置	Tower 7 第7座					Tower 8 第8座						
		G/F 地下	1/F 1樓		2/F - 3/F, 5/F - 10/F 2樓至 3樓、5樓至 10樓	11/F 11樓	G/F 地下	1/F 1樓		2/F - 3/F, 5/F - 8/F & 10/F 2樓至 3樓、5樓至 8樓及10樓	9/F 9樓		11/F 11樓
		• Garden Apartment	Flat A A單位	Flat B B單位	Flat A & B A及B單位	• Courtyard Penthouse	• Garden Apartment	Flat A A單位	Flat B B單位	Flat A & B A及B單位	Flat A A單位	Flat B B單位	• Courtyard Penthouse
Utility Room with Lavatory 附有洗手間之工作間	Air-conditioner Central Controller 冷氣中央控制器	/	-	-	-	1	/	-	-	-	-	-	1
	Town Gas Meter 煤氣計量錶	/	1	1	1	1	/	1	1	1	1	1	1
	Water Inlet / Outlet Connection Point for Washing Machine 洗衣機來/去水位接駁點	/	-	-	-	-	/	-	-	-	-	1	-
	Miniature Circuit Breaker Board 微型斷路箱	/	1	1	1	1	/	1	1	1	1	1	1
Utility Platform 工作平台	Lighting Point 燈位	/	1	1	1	1	/	1	1	1	1	1	1
Air-Conditioner Platform 空調機平台	Switch for A/C Outdoor Unit 空調室外機開關	/	6	6	6	/	6	6	6	6	6	/	
Balcony 露台	Lighting Point 燈位	/	1	1	1	1	/	1	1	1	1	1	1
Roof 天台	Lighting Point 燈位	/	/	/	/	11	/	/	/	/	/	/	11
	Single Waterproof Socket Outlet 防水單位電插座	/	/	/	/	1	/	/	/	/	/	/	1
Outdoor VRV Area 室外變頻中央空調系統空間	Switch for AC Outdoor Unit 空調室外機開關	2	/	/	/	2	2	/	/	/	/	/	2
Utility Room 工作間	Twin Socket Outlet 雙位電插座	1	/	/	/	2	1	/	/	/	/	/	2
	Lighting Point 燈位	3	/	/	/	1	3	/	/	/	/	/	1
	Lighting Switch 燈掣	2	/	/	/	1	2	/	/	/	/	/	1
	Fused Spur Unit 保險絲接線位	-	/	/	/	1	-	/	/	/	/	/	1
	Switch for Exhaust Fan 抽氣扇開關掣	1	/	/	/	-	1	/	/	/	/	/	-
	Water Inlet / Outlet Connection Point for Washing Machine 洗衣機來 / 去水位接駁點	1	/	/	/	1	1	/	/	/	/	/	1
Garden 花園	Lighting Point 燈位	7	/	/	/	/	8	/	/	/	/	/	/
	Single Waterproof Socket Outlet 防水單位電 插座	2	/	/	/	/	2	/	/	/	/	/	/
	Video Door Phone 視像對講機	1	/	/	/	/	1	/	/	/	/	/	/
	Fused Spur Unit 保險絲接線位	1	/	/	/	/	1	/	/	/	/	/	/

Notes:

- The symbol “ - ” as shown in the above table denotes “Not provided”.
- The symbol “ / ” as shown in the above table denotes “Not applicable”.
- “Terrace Apartment”, “Garden Apartment” and “Courtyard Penthouse” are names for marketing purposes only and will not appear in any Deed of Mutual Covenant, the Preliminary Agreement for Sale and Purchase, Agreement for Sale and Purchase, Assignment, or any other title deeds and documents relating to the Development. The names as appearing on the approved building plans are: Flat A on 1/F of Tower 1 for Terrace Apartment on 1/F of Tower 1; Flat B on G/F of Tower 2 for Garden Apartment on G/F of Tower 2; Flat B on G/F of Tower 3 for Garden Apartment on G/F of Tower 3; Flat A on G/F of Tower 7 for Garden Apartment on G/F of Tower 7; Penthouse on 11/F of Tower 7 for Courtyard Penthouse on 11/F of Tower 7; Flat B on G/F of Tower 8 for Garden Apartment on G/F of Tower 8; Penthouse on 11/F of Tower 8 for Courtyard Penthouse on 11/F of Tower 8.

備註:

- 上表內之「-」代表「不提供」。
- 上表內之「/」代表「不適用」。
- 「Terrace Apartment」、「Garden Apartment」及「Courtyard Penthouse」僅為市場推廣之用的名稱，並不會於關於發展項目的任何公契、臨時買賣合約、買賣合約、轉讓契及契據出現。經批准的建築圖則上顯示的名稱為：第1座1樓A單位（即第1座1樓Terrace Apartment）；第2座地下B單位（即第2座地下Garden Apartment）；第3座地下B單位（即第3座地下Garden Apartment）；第7座地下A單位（即第7座地下Garden Apartment）；第7座11樓Penthouse（即第7座11樓Courtyard Penthouse）；第8座地下B單位（即第8座地下Garden Apartment）；第8座11樓Penthouse（即第8座11樓Courtyard Penthouse）。

## SERVICE AGREEMENTS

### 服務協議

Potable and flushing water is supplied by Water Supplies Department.

Electricity is supplied by The CLP Power Hong Kong Limited.

Towngas is supplied by The Hong Kong and China Gas Company Limited.

食水及沖廁水由水務署供應。

電力由中華電力有限公司供應。

煤氣由香港中華煤氣有限公司供應。

## GOVERNMENT RENT 地稅

The vendor (the owner) is liable for the Government rent of a residential property up to and including the date of completion of the sale and purchase of that residential property.

賣方（擁有人）有法律責任繳付住宅物業的地稅直至住宅物業買賣完成日（包括該日）為止。

## MISCELLANEOUS PAYMENTS BY PURCHASER

### 買方的雜項付款

1. On the delivery of the vacant possession of the residential property to the purchaser, the purchaser is liable to reimburse the vendor (the owner) for the deposits for water, electricity and gas.
2. On that delivery, the purchaser is not liable to pay to the vendor (the owner) a debris removal fee.

Note :

- The purchaser should pay to the manager and not the vendor (the owner) of the Development the deposits for water, electricity and gas and the debris removal fee.
- The amount of deposits for water, electricity and gas and debris removal fee is yet to be ascertained at the date on which the sales brochure is printed.

1. 在向買方交付住宅物業在空置情況下的管有權時，買方須向賣方(擁有人)補還水、電力及氣體的按金。
2. 在交付時，買方不須向賣方(擁有人)支付清理廢料的費用。

備註：

- 買方須向發展項目管理人及不須向賣方（擁有人）繳付水、電力及氣體的按金及清理廢料的費用。
- 水、電力及氣體的按金及清理廢料的費用的款額於售樓說明書印製日尚未決定。

## DEFECT LIABILITY WARRANTY PERIOD

### 欠妥之處的保養責任期

Defect liability warranty period for the residential property and the fittings, finishes and appliances as provided in the Agreement for Sale and Purchase is within six (6) months from the date of completion of the sale and purchase.

按買賣合約的規定，住宅物業及其裝置、裝修物料或設備之欠妥之處的保養責任期為住宅物業之成交日期起計為期6個月內。



## MAINTENANCE OF SLOPES

### 斜坡維修

1. The Land Grant requires the owners of the residential properties in the Development to maintain slopes at their own cost.

Special Conditions No. (31) of the Land Grant stipulates that:-

- “(a) Where there is or has been any cutting away, removal or setting back of any land, or any building-up or filling-in or any slope treatment works of any kind whatsoever, whether with or without the prior written consent of the Director, either within the Lot or on any Government land, which is or was done for the purpose of or in connection with the formation, levelling or development of the Lot or any part thereof or any other works required to be done by the Purchaser under these Conditions, or for any other purpose, the Purchaser shall at his own expense carry out and construct such slope treatment works, retaining walls or other support, protection, drainage or ancillary or other works as shall or may then or at any time thereafter be necessary to protect and support such land within the lot and also any adjacent or adjoining Government or leased land and to obviate and prevent any falling away, landslip or subsidence occurring thereafter. The Purchaser shall at all times during the term hereby agreed to be granted maintain at his own expense the said land, slope treatment works, retaining walls or other support, protection, drainage or ancillary or other works in good and substantial repair and condition to be satisfaction of the Director.
- (b) Nothing in sub-clause (a) of this Special Condition shall prejudice the Government’s rights under these Conditions, in particular Special Condition No. (30) hereof.
- (c) In the event that as a result of or arising out of any formation, levelling, development or other works done by the Purchaser or owing to any other reason, any falling away, landslip or subsidence occurs at any time, whether in or from any land within the Lot or from any adjacent or adjoining Government or leased land, the Purchaser shall at his own expense reinstate and make good the same to the satisfaction of the Director and shall indemnify the Government, its agents and contractors from and against all costs, charges, damages, demands and claims whatsoever which shall or may be made, suffered or incurred through or by reason of such falling away, landslip or subsidence.
- (d) In addition to any other rights or remedies herein provided for breach of any of these Conditions, the Director shall be entitled by notice in writing to call upon the Purchaser to carry out, construct and maintain the said land, slope treatment works, retaining walls, or other support, protection, and drainage or ancillary or other works or to reinstate and make good any falling away, landslip or subsidence, and if the Purchaser shall neglect or fail to comply with the notice to the satisfaction of the Director within the period specified therein, the Director may forthwith execute and carry out any necessary works and the Purchaser shall on demand repay to the Government the cost thereof, together with any administrative and professional fees and charges.”

Special Conditions No. (37) of the Land Grant stipulates that:-

- “(a) The Purchaser acknowledges that as at the date of this Agreement, there are retaining wall, structure or structures supporting the adjoining Lai Ping Road in the vicinity of the area shown coloured pink hatched brown on the plan annexed hereto (hereinafter referred to as “the Pink Hatched Brown Area” and which retaining wall, structure or structures are hereinafter collectively referred to as “the Retaining Wall”).
- (b) The Purchaser shall take or cause to be taken all proper and adequate care, skill and precautions at all times, and particularly when carrying out any work upon, over, under, in or within the Pink Hatched Brown Area (hereinafter referred to as “the said Works”) to avoid causing any damage, disturbance or interference to the Retaining Wall. The Purchaser shall at his own expense and within such time limit as may be specified by the Director repair, make good and reinstate the Retaining Wall in all respects to the satisfaction of the Director any damage, disturbance or interference caused to the Retaining Wall in any manner arising of the said Works. The Purchaser shall prior to carrying out the said Works at his own expense take such precautions and measures as may be required by the Director to ensure that the Retaining Wall will not be damaged, disturbed or interfered with.
- (c) For the purpose of this Special Condition, the decision of the Director as to what constitutes the Retaining Wall shall be final and binding on the Purchaser.
- (d) The Purchaser shall throughout the term hereby agreed to be granted permit the Government, the Director and his officers, contractors, agents and any persons authorized by it or them and its or their workmen the right of ingress, egress and regress to, from and through the Pink Hatched Brown Area at all reasonable times with or without tools, equipment, plant, machinery or motor vehicles for the purposes of inspecting, repairing or maintaining the Retaining Wall or the carrying out of any works which the Director may consider necessary in connection with the Retaining Wall.
- (e) The Government, the Director and his officer, contractors, agents and any persons authorized by it or them and its or their workmen shall have no liability in respect of any loss, damage, nuisance or disturbance whatsoever caused to or

suffered by the Purchaser or any person whether arising out of or incidental to the exercise by it or them of the rights conferred under sub-clause (d) of this Special Condition, and no claim whatsoever shall be made against it or them by the Purchaser in respect of any such loss, damage, nuisance or disturbance.”

2. Each of the owners is obliged to contribute towards the costs of the maintenance work.
3. The plan showing the slopes and any retaining wall or related structures constructed, or to be constructed, within or outside the land on which the Development is situated is set out below.
4. Owner’s undertaking to maintain any slope in relation to the Development at the owner’s own costs: Not applicable.
5. Under the DMC, the manager of the Development has the owners’ authority to carry out the maintenance work.

## MAINTENANCE OF SLOPES

### 斜坡維修

1. 批地文件規定，發展項目中的住宅物業的擁有人須自費維修斜坡。

批地文件第(31)條批地特別條款訂明：

- “(a) 如果任何土地被或已經被削去、移除或削減，或進行堆積或堆填或任何類型的斜坡處理工程，不論有否經署長預先書面同意，亦不論是在該土地內或任何政府土地內，旨在塑造、平整或發展該地段或其中任何部分或買方按本文件需要進行的任何其他工程或作任何其他用途，買方須自費進行與修建該等斜坡處理工程、護土牆或其他支撐物、保護物、排水或輔助工程或今後成為必要的其他工程，以便保護與支撐該地段和任何毗鄰或毗連政府土地或出租土地內的泥土，避免與防止今後發生任何塌方、山泥傾瀉或地陷。買方須在批地文件授予的租期期間自費保養該土地、斜坡處理工程、護土牆或其他支撐物、保護物、排水或輔助工程或其他工程處於良好及修繕妥當的狀態，使署長滿意。
- (b) 本特別條款第(a)分條不能影響本文件，特別是批地文件特別條款第(30)條賦予政府的權利。
- (c) 倘若因為任何塑造、平整、發展或買方進行其他工程或任何其他原因造成任何時候發生塌方、山泥傾瀉或地陷，不論發生在或來自該地段任何土地或任何毗鄰或毗連政府土地或出租土地，買方須自費進行修復或彌補，使署長滿意並對上述塌方、山泥傾瀉或地陷造成政府、他的代理人及承建商蒙受、遭受或產生一切費用、收費、損害賠償、要求及索償做出彌償。
- (d) 除了批地文件規定對違反該文件的任何其他權利或濟助外，署長有權發出書面通知要求買方進行、修建及保養該土地、斜坡處理工程、護土牆或其他支撐物、保護物及排水或輔助工程或其他工程或修復與彌補任何塌方、山泥傾瀉或地陷。如果買方不理會或未能在通知指定的時期內執行該通知要求，使署長滿意，署長可立即執行與進行任何必要工程。買方須在要求時歸還政府因此產生的費用連同任何行政費或專業費用及開支。”

批地文件第(37)條批地特別條款訂明：

- “(a) 買方承認在本協議之日在本文件附錄的圖則上用粉紅色加棕斜線顯示附近的範圍建有護土牆、構築物或承托毗鄰麗坪路的構築物(以下簡稱為「粉紅色加棕斜線範圍」和該等護土牆或構築物在下文統稱為「護土牆」)。
- (b) 買方須在任何時候盡一切適當及足夠的細心、技巧及專注，特別是在粉紅色加棕斜線範圍之上、上面、之下、之內或內部進行任何工程時，以避免對護土牆造成任何損壞、干擾或干涉。買方須在署長指定的時間內自費維修、彌補及修復上述工程以任何方式造成護土牆的任何損壞、干擾或干涉，在一切方面使署長滿意。買方在進行上述工程之前，須自費採取署長要求的預防措施及措施，確保護土牆不受到損壞、干擾或干涉。
- (c) 在本特別條款中，署長對護土牆的定義之決定是最終的及約束買方。
- (d) 買方須在本文件授予的整個租期期間准許政府、署長、他的官員、承辦商、代理人及他或他們授權的任何人士或他們的工人有權在任何合理時間內帶上或不帶工具、設備、機械、機器或車輛出入及經過粉紅色加棕斜線範圍，以便視察、維修或保養護土牆或進行署長認為保養護土牆所必要的任何工程。
- (e) 政府、署長、他的官員、承辦商、代理人及他或他們授權的任何人士或他們的工人對他們行使本特別條款第(d)分條的權利所產生或附帶對買方或任何人士造成任何損失、損害、滋擾或干擾毋須承擔任何責任，買方不能對上述任何損失、損害、滋擾或干擾向他們提出任何索償。”

2. 每名擁有人均須分擔維修工程項目的費用。

3. 以下顯示斜坡及已經或將會在該土地之內或之外建造的任何護土牆或有關構築物的圖則。

4. 擁有人自費就發展項目維修任何斜坡的承諾: 不適用。

5. 根據公契發展項目的管理人獲擁有人授權進行維修工程。

### Slope And Retaining Structure Plan

斜坡及護土構築物圖則

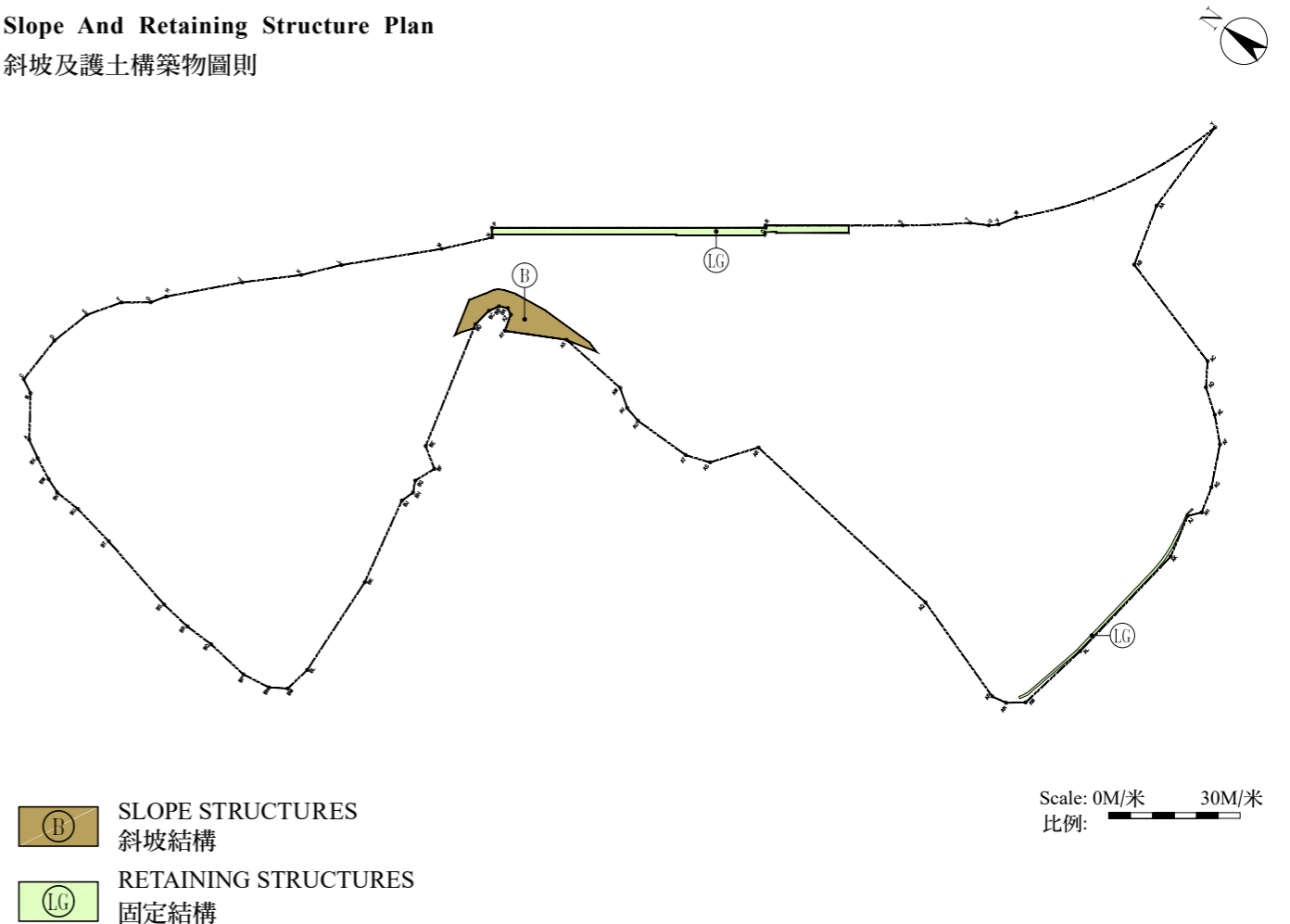

## MODIFICATION

### 修訂

The Vendor has made an application at its own costs and expenses to District Lands Office/Shah Tin, Lands Department to modify Special Condition No. (27) of the Land Grant. The application is to apply for an additional set of vehicular access points between X and Y through Z as shown on the plan annexed to the Land Grant.

賣方已自費向沙田地政處作出申請修改批地文件的特別條件第(27)條。該申請的目的為申請額外一組車輛進出點，如在批地文件的附圖上顯示的X點及Y點(經Z點)。

RELEVANT INFORMATION

有關資料

Tree Compensation Plan (G/F Plan)

樹木補償方案示意圖(地下平面圖)

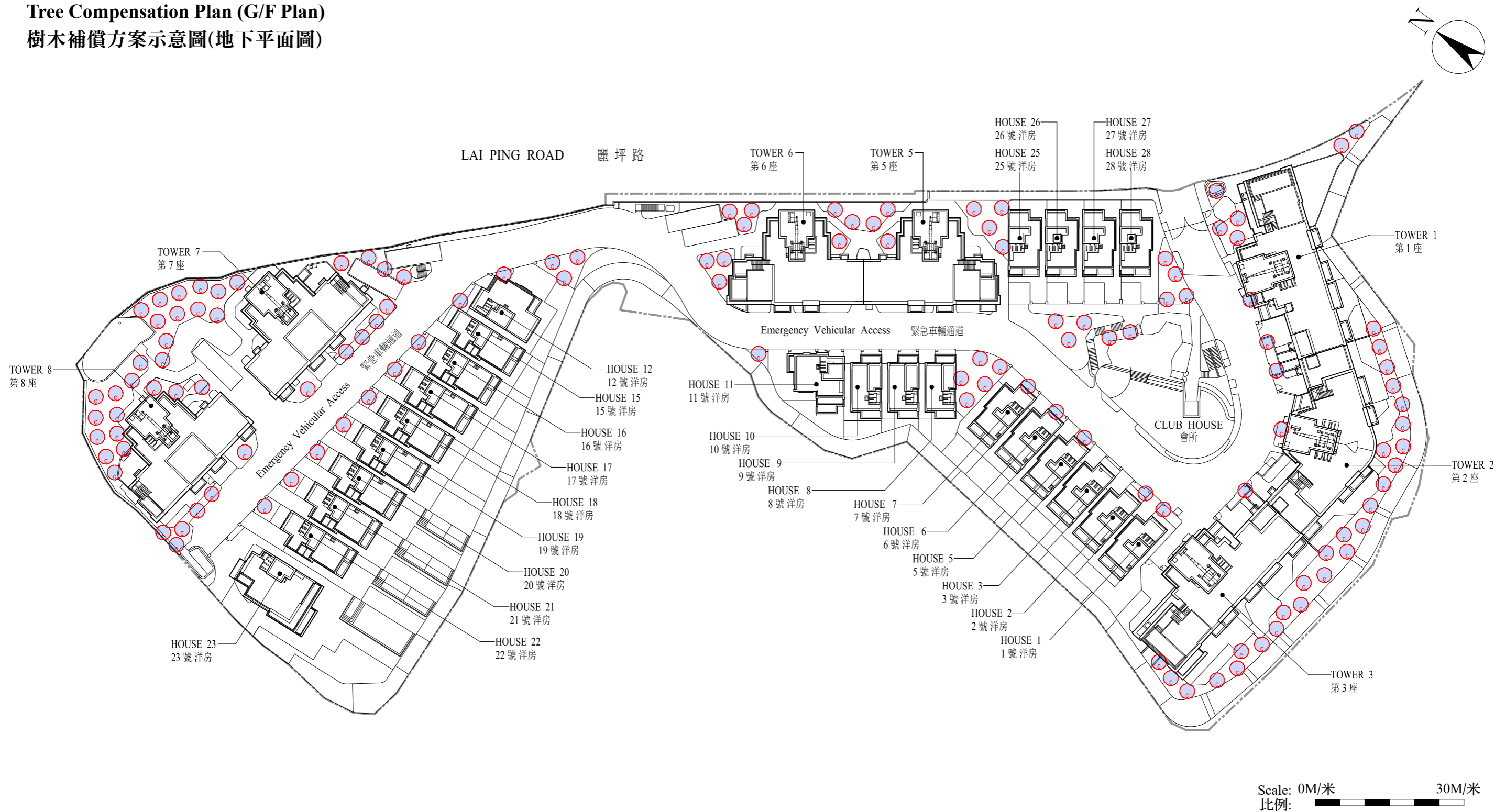

The last updated version of the Tree Compensation Plan approved by the District Lands Office, Sha Tin Department as of the date of printing of the sales brochure is available for free inspection during normal office hours at the sales office. 在印製售樓說明書當日適用的最近更新版本經地政總署沙田地政處批准的樹木補償方案示意圖存於售樓處，於正常辦公時間內供免費查閱。

--- Boundary of the Development  
發展項目的邊界

○ Trees in the Common Areas of the Development  
於發展項目公用地方的樹

## WEBSITE ADDRESS

### 互聯網網站網址

The address of the website designated by the vendor for the Development for the purpose of Part 2 of the Residential Properties (First-hand Sales) Ordinance:  
[www.mountregalia.hk](http://www.mountregalia.hk)

賣家為施行《一手住宅物業銷售條例》第2部而就發展項目指定的互聯網網站的網址：  
[www.mountregalia.hk](http://www.mountregalia.hk)



## INFORMATION IN APPLICATION FOR CONCESSION ON GROSS FLOOR AREA OF BUILDING

### 申請建築物總樓面面積寬免的資料

#### Breakdown of GFA Concessions Obtained for All Features

Latest information on breakdown of GFA concessions as shown on the general building plans submitted to and approved by the Building Authority (BA) prior to the printing of the sales brochure is tabulated below. Information marked (#) may be based on information provided by the authorized person if the sales brochure is printed prior to submission of the final amendment plans to the BA. The breakdown of GFA concessions may be subject to further changes until final amendment plans are submitted to and approved by the BA prior to the issuance of the occupation permit for the development.

		Area(m <sup>2</sup> )
<b>Disregarded GFA under Building (Planning) Regulations 23(3)(b)</b>		
1.(#)	Carpark and loading/unloading area excluding public transport terminus	10,630.466
2.	<b>Plant rooms and similar services</b>	
2.1	Mandatory feature or essential plant room, area of which is limited by respective Practice Notes for Authorized Persons, Registered Structural Engineers and Registered Geotechnical Engineers (PNAP) or regulation such as lift machine room, telecommunications and broadcasting (TBE) room, refuse storage and material recovery chamber, etc.	768.583
2.2 (#)	Mandatory feature or essential plant room, area of which is NOT limited by any PNAP or regulation such as room occupied solely by fire services installations (FSI) and equipment, meter room, transformer room, potable and flushing water tank, etc.	2,940.902
2.3	Non-mandatory or non-essential plant room such as air-conditioning (A/C) plant room, air handling unit (AHU) room, etc.	251.008
<b>Green Features under Joint Practice Notes 1 and 2</b>		
3.	Balcony	638.891
4.	Wider common corridor and lift lobby	Not Applicable
5.	Communal sky garden	Not Applicable
6.	Acoustic fin	Not Applicable
7.	Wing wall, wind catcher and funnel	Not Applicable
8.	Non-structural prefabricated external wall	192.137
9.	Utility platform	118.500
10.	Noise barrier	Not Applicable
<b>Amenity Features</b>		
11.	Caretaker's quarters, counter, office, store, guard room and lavatory for watchman and management staff and owners' corporation office	34.793
12.	Residential recreational facilities including void, plant room, swimming pool filtration plant room, covered walkway, etc. serving solely the recreational facilities	1,427.044
13.	Covered landscaped and play area	230.141
14.	Horizontal screen/covered walkway and trellis	Not Applicable
15.	Larger lift shaft	153.018
16.	Chimney shaft	1.425
17.	Other non-mandatory or non-essential plant room, such as boiler room, satellite master antenna television (SMATV) room	Not Applicable
18. (#)	Pipe duct, air duct for mandatory feature or essential plant room	378.541

		Area(m <sup>2</sup> )
19.	Pipe duct, air duct for non-mandatory or non-essential plant room	Not Applicable
20.	Plant room, pipe duct, air duct for environmentally friendly system and feature	Not Applicable
21.	Void in duplex domestic flat and house	55.504
22.	Sunshade and reflector	Not Applicable
23. (#)	Minor projection such as A/C box, A/C platform, window cill and projecting window	906.599
24.	Other projection such as A/C box and platform not covered in paragraph 3(b) and (c) of PNAP APP-19	Not Applicable
<b>Other Exempted Items</b>		
25. (#)	Refuge floor including refuge floor cum sky garden	Not Applicable
26.	Covered area under large projecting/ overhanging feature	Not Applicable
27.	Public transport terminus	Not Applicable
28. (#)	Party structure and common staircase	Not Applicable
29. (#)	Horizontal area of staircase, lift shaft and vertical duct solely serving floor accepted as not being accountable for GFA	93.157
30.	Public passage	Not Applicable
31.	Covered set back area	Not Applicable
<b>Bonus GFA</b>		
32.	Bonus GFA	Not Applicable
<b>Additional Green Features under Joint Practice Note (No. 8)</b>		
33.	Buildings adopting Modular Integrated Construction	Not Applicable

Note: The above table is based on the requirements as stipulated in the Practice Note for Authorized Persons, Registered Structural Engineers and Registered Geotechnical Engineers ADM-2 issued by the Buildings Department. The Buildings Department may revise such requirements from time to time as appropriate.

## INFORMATION IN APPLICATION FOR CONCESSION ON GROSS FLOOR AREA OF BUILDING

### 申請建築物總樓面面積寬免的資料

#### 獲寬免總樓面面積的設施分項

於印製售樓說明書前呈交予並已獲建築事務監督批准的一般建築圖則上有關總樓面面積寬免的分項的最新資料，請見下表。如印製售樓說明書時尚未呈交最終修訂圖則予建築事務監督，則有(＃)號的資料可以由認可人士提供的資料作為基礎。直至最終修訂圖則於發出佔用許可證前呈交予並獲建築事務監督批准前，以下分項資料仍可能有所修改。

		面積(平方米)
<b>根據《建築物(規劃)規例》第 23(3)(b) 條不計算的總樓面面積</b>		
1.(#)	停車場及上落客貨地方(公共交通總站除外)	10,630.466
2.	<b>機房及相類設施</b>	
2.1	所佔面積受相關《認可人士、註冊結構工程師及註冊岩土工程師作業備考》(《作業備考》)或規例限制的強制性設施或必要機房，例如升降機機房、電訊及廣播設備室、垃圾及物料回收房等	768.583
2.2 (#)	所佔面積不受任何《作業備考》或規例限制的強制性設施或必要機房，例如僅由消防裝置及設備佔用的房間、電錶房、電力變壓房、食水及鹹水缸等	2,940.902
2.3	非強制性或非必要機房，例如空調機房、送風櫃房等	251.008
<b>根據聯合作業備考第 1 及第 2 號提供的環保設施</b>		
3.	露台	638.891
4.	加闊的公用走廊及升降機大堂	不適用
5.	公用空中花園	不適用
6.	隔聲簷	不適用
7.	翼牆、捕風器及風斗	不適用
8.	非結構預製外牆	192.137
9.	工作平台	118.500
10.	隔音屏障	不適用
<b>適意設施</b>		
11.	管理員宿舍、供保安人員和管理處員工使用的櫃位、辦事處、貯物室、警衛室和廁所，以及業主立案法團辦事處	34.793
12.	住戶康樂設施，包括僅供康樂設施使用的中空空間、機房、游泳池的濾水機房、有蓋人行道等	1,427.044
13.	有蓋園景區及遊樂場地	230.141
14.	橫向屏障/有蓋人行道及花棚	不適用
15.	擴大升降機槽	153.018
16.	煙囪管道	1.425
17.	其他非強制性或非必要機房，例如鍋爐房、衛星電視共用天線房	不適用
18. (#)	強制性設施或必要機房所需的管槽及氣槽	378.541

		面積(平方米)
19.	非強制性設施或非必要機房所需的管槽及氣槽	不適用
20.	環保系統及設施所需的機房、管槽及氣槽	不適用
21.	複式住宅單位及洋房的中空空間	55.504
22.	遮陽篷及反光罩	不適用
23. (#)	小型伸出物，例如空調機箱、空調機平台、窗檻及伸出的窗台	906.599
24.	《作業備考》APP-19 第 3(b) 及 (c) 段沒有涵蓋的其他伸出物，如空調機箱及空調機平台	不適用
<b>其他項目</b>		
25. (#)	庇護層，包括庇護層兼空中花園	不適用
26.	大型伸出/外懸設施下的有蓋地方	不適用
27.	公共交通總站	不適用
28. (#)	共用構築物及公用樓梯	不適用
29. (#)	僅供獲接納不計入總樓面面積的樓層使用的樓梯、升降機槽及垂直管道的水平面積	93.157
30.	公眾通道	不適用
31.	有蓋的後移部分	不適用
<b>額外總樓面面積</b>		
32.	額外總樓面面積	不適用
<b>根據聯合作業備考(第 8 號)提供的額外環保設施</b>		
33.	採用「組裝合成」建築法的樓宇	不適用

註：上述表格是根據屋宇署所發出的《認可人士、註冊結構工程師及註冊岩土工程師作業備考》ADM-2 規定的要求而制訂的。屋宇署會按實際需要不時更改有關要求。

## INFORMATION IN APPLICATION FOR CONCESSION ON GROSS FLOOR AREA OF BUILDING

### 申請建築物總樓面面積寬免的資料

#### The Environmental Assessment of the Building

The Development has achieved the BRONZE rating under the BEAMS Plus V1.2 for New Building.



#### 有關建築物的環境評估

發展項目獲得綠建環評1.2版(新建建築)銅級。



## INFORMATION IN APPLICATION FOR CONCESSION ON GROSS FLOOR AREA OF BUILDING

### 申請建築物總樓面面積寬免的資料

#### Estimated Energy Performance or Consumption for the Common Parts of the Development

發展項目的公用部分的預計能量表現或消耗

Latest information on the estimated energy performance or consumption for the common parts of the development as submitted to the Building Authority prior to the printing of the sales brochures:

於印製售樓說明書前呈交予建築事務監督發展項目的公用部分的預計能量表現或消耗的最近期資料：

Part I 第 I 部分	
Provision of Central Air Conditioning 提供中央空調	YES/ NO 是 / 否
Provision of Energy Efficient Features 提供具能源效益的設施	YES / <del>NO</del> 是 / 否
Energy Efficient Features proposed: 擬安裝的具能源效益的設施	1. Air conditioner energy label grade 2 or above; 2. T5 fluorescent fitting. 1. 能源標籤分體式冷氣二級或以上; 2. T5 熒光燈管照明。

Part II : The predicted annual energy use of the proposed / completed building / part of building <sup>(Note 1)</sup> 第 II 部分: 擬興建/已竣工樓宇/部分樓宇預計每年能源消耗量 <sup>(註腳1)</sup> :-					
Location 位置	Internal Floor Area Served (m <sup>2</sup> ) 使用有關裝置的內部樓面面積 (平方米)	Annual Energy Use of Baseline Building <sup>(Note 2)</sup> 基線樓宇 <sup>(註腳2)</sup> 每年能源消耗量		Annual Energy Use of Proposed Building 擬興建樓宇每年能源消耗量	
		Electricity kWh/ m <sup>2</sup> /annum 電力 千瓦小時/平方米/年	Town Gas / LPG unit/ m <sup>2</sup> /annum 煤氣/石油氣 用量單位/平方米/年	Electricity kWh/ m <sup>2</sup> /annum 電力 千瓦小時/平方米/年	Town Gas / LPG unit/ m <sup>2</sup> /annum 煤氣/石油氣 用量單位/平方米/年
Central building services installation <sup>(Note 3)</sup> (Domestic) 中央屋宇裝備裝置 <sup>(註腳3)</sup> (住用)	5,906.8	242.0	0	196.6	0
Area served by central building services installation <sup>(Note 3)</sup> (Non-domestic - Podium(s)) 基座(包括商業及會所)(有使用中央屋宇裝備裝置 <sup>(註腳3)</sup> 的部分)	12,846.7	90.8	0	83.1	0

Part III: The following installation(s) is / are* completed in accordance with the relevant Codes of Practices published by the Electrical & Mechanical Services Department (EMSD) 第 III 部分: 以下裝置乃按機電工程署公布的相關實務守則完成:-			
Type of Installations 裝置類型	YES 是	NO 否	N/A 不適用
Lighting Installations 照明裝置	✓		
Air Conditioning Installations 空調裝置	✓		
Electrical Installations 電力裝置	✓		
Lift & Escalator Installations 升降機及自動梯的裝置	✓		
Performance-based Approach 以總能源為本的方法			✓

## INFORMATION IN APPLICATION FOR CONCESSION ON GROSS FLOOR AREA OF BUILDING

### 申請建築物總樓面面積寬免的資料

#### Notes:

- In general, the lower the estimated “Annual Energy Use” of the building, the more efficient of the building in terms of energy use. For example, if the estimated “annual energy use of proposed building” is less than the estimated “annual energy use of baseline building”, it means the predicted use of energy is more efficient in the proposed building than in the baseline building. The larger the reduction, the greater the efficiency.  
The predicted annual energy use, in terms of electricity consumption (kWh/m<sup>2</sup>/annum) and town gas/LPG consumption (unit/m<sup>2</sup>/annum), of the development by the internal floor area served, where:
  - “total annual energy use” has the same meaning of “annual energy use” in the BEAM Plus New Buildings (current version); and
  - “internal floor area”, in relation a building, a space or a unit means the floor area of all enclosed space measured to the internal faces of enclosing external and/or party walls.
- “Baseline Building” has the same meaning as “Baseline Building Model (zero-credit benchmark)” in the BEAM Plus New Buildings (current version).
- “Central Building Services Installation” has the same meaning as that in the Code of Practice for Energy Efficiency of Building Services Installation issued by the Electrical and Mechanical Services Department.
- Podium(s) normally means the lowest part of the development (usually the lowest 15m of the development and its basement, if any) carrying different use(s) from that of the tower(s) above. For development without clear demarcation between podium(s) and tower(s), the development, as a whole, should be considered as tower(s).

#### 備註：

- 一般而言，一棟樓宇的預計“每年能源消耗量”愈低，其節約能源的效益愈高。如一棟樓宇預計的“每年能源消耗量”低於該樓宇的“基線樓宇每年能源消耗量”，則代表預計該樓宇的能源應用較其基線樓宇有效，削減幅度愈大則代表有關樓宇能源節約的效益愈高。  
預計每年能源消耗量[以耗電量(千瓦小時/平方米/年)及煤氣/石油氣消耗量(用量單位/平方米/年)計算]，指將發展項目的每年能源消耗總量除以使用有關裝置的內部樓面面積所得出的商，其中：
  - “每年能源消耗量”與新建樓宇 BEAM Plus 標準（現行版本）中的「年能源消耗」具有相同涵義；及
  - 樓宇、空間或單位的“內部樓面面積”，指外牆及／或共用牆的內壁之內表面起量度出來的樓面面積。
- “基準樓宇”與新建樓宇 BEAM Plus 標準（現行版本）中的“基準建築物模式（零分標準）”具有相同涵義。
- “中央屋宇裝備裝置”與機電工程署發出的《屋宇裝備裝置能源效益實務守則》中的涵義相同。
- 平台一般指發展項目的最低部分（通常為發展項目最低15米部分及其他庫（如適用）），並與其上的塔樓具有不同用途。對於並無明確劃分平台與塔樓的發展項目，應視整個發展項目為塔樓。







**Date of Printing of Sales Brochure 售樓說明書印製日期**

Date of printing of this Sales Brochure:  
12 March 2019

本售樓說明書印製日期：  
2019年3月12日

**Possible Future Change 日後可能出現改變**

There may be future changes to the Development and the surrounding areas.

發展項目及其周邊地區日後可能出現改變。

# EXAMINATION RECORD

## 檢視紀錄

Examination/Revision Date 檢視日期	Revision Made 所作修改	
	Page Number 頁次	Revision Made 所作修改
12 June 2019 2019年6月12日	Page 18 第 18 頁	Location Plan is updated 更新發展項目的所在位置圖
	Page 26 第 26 頁	Legend is updated 更新圖例
	Page 28, 30, 31, 32, 34, 36, 38, 46, 48, 50, 52, 54, 56, 58, 60, 62, 64, 66-74, 80, 82, 92, 108, 118 第 28, 30, 31, 32, 34, 36, 38, 46, 48, 50, 52, 54, 56, 58, 60, 62, 64, 66-74, 80, 82, 92, 108 及 118 頁	Floor plans are revised 修訂平面圖
	Page 239, 240, 258, 277, 278, 291, 295, 298, 302, 305, 306, 310, 311-313, 323 第 239, 240, 258, 277, 278, 291, 295, 298, 302, 305, 306, 310, 311-313 及 323 頁	The provisions under Fittings, Finishes and Appliances are revised 修訂裝置、裝修物料及設備之內容
12 September 2019 2019年9月12日	Page 18 第 18 頁	Location Plan is updated 更新發展項目的所在位置圖
	Page 86, 88, 90, 91, 92, 100, 102 第 86, 88, 90, 91, 92, 100 及 102 頁	Floor plans are revised 修訂平面圖
	Page 272 第 272 頁	The provisions under Fittings, Finishes and Appliances are revised 修訂裝置、裝修物料及設備之內容
27 September 2019 2019年9月27日	Page 335 第 335 頁	Modification is updated 更新修訂
23 December 2019 2019年12月23日	Page 18 第 18 頁	Location Plan is updated 更新發展項目的所在位置圖
	Page 19, 20, 21, 22 第 19, 20, 21, 22 頁	Aerial Photograph are updated 更新發展項目的鳥瞰照片
23 March 2020 2020年3月23日	Page 8 第 8 頁	Information on Vendor and others involved in the Development is updated 更新賣方及有參與發展項目的其他人的資料
	Page 18 第 18 頁	Location Plan is updated 更新發展項目的所在位置圖
	Page 102 第 102 頁	Floor plans are revised 修訂平面圖
17 June 2020 2020年6月17日	Page 18 第 18 頁	Location Plan is updated 更新發展項目的所在位置圖
	Page 21, 22 第 21, 22 頁	Aerial Photograph are updated 更新發展項目的鳥瞰照片
	Page 228 第 228 頁	The provisions under Fittings, Finishes and Appliances are revised 修訂裝置、裝修物料及設備之內容
	Page 340 第 340 頁	The Environmental Assessment of the Building are updated 更新有關建築物的環境評估

# EXAMINATION RECORD

## 檢視紀錄

Examination/Revision Date 檢視日期	Revision Made 所作修改	
	Page Number 頁次	Revision Made 所作修改
16 September 2020 2020年9月16日	Page 8 第 8 頁	Information on Vendor and others involved in the Development is updated 更新賣方及有參與發展項目的其他人的資料
	Page 18 第 18 頁	Location Plan is updated 更新發展項目的所在位置圖
16 December 2020 2020年12月16日	Page 18 第 18 頁	Location Plan is updated 更新發展項目的所在位置圖
	Page 19, 20, 21, 22 第 19, 20, 21, 22 頁	Aerial Photograph are updated 更新發展項目的鳥瞰照片
16 March 2021 2021年3月16日	Page 8 第 8 頁	Information on Vendor and others involved in the Development is updated 更新賣方及有參與發展項目的其他人的資料
	Page 18 第 18 頁	Location Plan is updated 更新發展項目的所在位置圖
16 June 2021 2021年6月16日	Page 18 第 18 頁	Location Plan is updated 更新發展項目的所在位置圖
16 September 2021 2021年9月16日	Page 1, 2, 3, 4, 5, 6 第 1, 2, 3, 4, 5, 6 頁	Notes to Purchasers of First-hand Residential Properties is updated 更新一手住宅物業買家須知
	Page 18 第 18 頁	Location Plan is updated 更新發展項目的所在位置圖
16 December 2021 2021年12月16日	Page 18 第 18 頁	Location Plan is updated 更新發展項目的所在位置圖
	Page 19, 20, 21, 22 第 19, 20, 21, 22 頁	Aerial Photograph are updated 更新發展項目的鳥瞰照片
	Page 23 第 23 頁	Outline Zoning Plan relating to the Development is updated 更新關乎發展項目的分區計劃大綱圖
16 March 2022 2022年3月16日	Page 18 第 18 頁	Location Plan is updated 更新發展項目的所在位置圖
16 June 2022 2022年6月16日	Page 18 第 18 頁	Location Plan is updated 更新發展項目的所在位置圖
17 August 2022 2022年8月17日	Page 89, 90 第 89, 90 頁	Floor plans are revised 修訂平面圖
	Page 90a, 90b (additional pages) 第 90a, 90b 頁 (加頁)	Floor plans are revised 修訂平面圖
	Page 225, 226, 227, 228, 229, 230, 231, 232, 233, 234, 258, 271, 302, 303, 304, 305, 306, 307, 308, 309 第 225, 226, 227, 228, 229, 230, 231, 232, 233, 234, 258, 271, 302, 303, 304, 305, 306, 307, 308, 309 頁	The provisions under Fittings, Finishes and Appliances are revised 修訂裝置、裝修物料及設備之內容



# EXAMINATION RECORD

## 檢視紀錄

Examination/Revision Date 檢視日期	Revision Made 所作修改	
	Page Number 頁次	Revision Made 所作修改
16 September 2022 2022年9月16日	Page 18 第 18 頁	Location Plan is updated 更新發展項目的所在位置圖
16 December 2022 2022年12月16日	Page 18 第 18 頁	Location Plan is updated 更新發展項目的所在位置圖
	Page 23 第 23 頁	Outline Zoning Plan relating to the Development is updated 更新關乎發展項目的分區計劃大綱圖
16 March 2023 2023年3月16日	Page 18 第 18 頁	Location Plan is updated 更新發展項目的所在位置圖
	Page 19 第 19 頁	Aerial Photograph is updated 更新發展項目的鳥瞰照片
	Page 20, 21, 22 第 20, 21, 22 頁	“Aerial Photograph of the Development” is deleted and replaced with blank page 刪除「發展項目的鳥瞰照片」並換上空白頁
16 June 2023 2023年6月16日	Page 3, 6 第 3, 6 頁	Notes to Purchasers of First-Hand Residential Properties is updated 更新一手住宅物業買家須知
	Page 18 第 18 頁	Location Plan is updated 更新發展項目的所在位置圖
	Page 19, 20, 21, 22 第 19, 20, 21, 22 頁	Aerial Photograph are updated 更新發展項目的鳥瞰照片
15 September 2023 2023年9月15日	Page 18 第 18 頁	Location Plan is updated 更新發展項目的所在位置圖
	Page 21, 22, 22a 第 21, 22, 22a 頁	Aerial Photograph are updated 更新發展項目的鳥瞰照片
	Page 338, 339, 342 第 338, 339, 342 頁	Information in application for concession on gross floor area of building is updated 更新申請建築物總樓面面積寬免的資料
15 December 2023 2023年12月15日	Page 18 第 18 頁	Location Plan is updated 更新發展項目的所在位置圖
	Page 23 第 23 頁	Outline Zoning Plan relating to the Development is updated 更新關乎發展項目的分區計劃大綱圖
15 March 2024 2024年3月15日	Page 18 第 18 頁	Location Plan is updated 更新發展項目的所在位置圖





